

BALANCES & TEST SERVICE

for laboratory, industry and food industry

BALANCES & TEST SERVICE for laboratory, industry and food industry

2019

175
KERN & SOHN
Balance manufacture in the
Sauter family-owned company
250



2019

How do I quickly find the product I am looking for?

The tried and tested quick search system – “Quick-Finder” ahead of each product group allows you to base the search for a certain target group on weighing data you need such as readout, weighing capacity and main features for each model.

And it's as simple as that – find the product you want in 2 steps:

1. Go to the product group index on page 3
2. Pick the appropriate product group and find the product you want using the Quick-Finder.

... or use the model name and find the product quickly and efficiently using the A-Z model list:

KERN Models A – Z

440	33	FKT	66/67	N	
572 · 573	37	FOB-S/FOB-NS	72	NFB	132
A		FOB/FOB-LM	73	NFN	133
ABJ-NM/ABS-N	48	FOB-NL	74	P	
ABP	50/51	FXN-N/FXN-M	77	PBJ/PBS	41
ABT-NM	49	G		PCB	32
ADB	45	GAB-N	64	PCD	31
ALJ-A/ALS-A	46/47	GAT	68/69	PEJ/PES	42
B		H		PFB	34
BFA	122	HCB/HCN	152	PLJ/PLS	38
BFB	120/121	HCD	153	PNJ/PNS	39
BFN	124	HDB-N/HDB-XL	151	R	
BIC	117	HFA	154	RFE	83
BID/BID-D	118/119	HFB	156	RIB	81
BKN	125/126	HFC	155	RPB	82
BXS	123	HFD	157	S	
C		HFM/HFO	158	SFB/SFB-H	78
CH	151	HFT	159	SFE	107
CCS	92/93	HGA	150	SXS	79
CDS	91	I		T	
CFS	88	IFB	105	TAB	21
CKE	89	IFS	90	TGB	20
CM	20	IFT	112/113	TEE	20
CM-C	21	IKT	110/111	TGC	20
CPB	87	IOC	104	TGD	21
CXB/CXB-NM	86	IXS	108/109	U	
D		K		UFA	127
DAB	54	KB-N	35	UFB	129
DBS	55	KDP	11	UFC	130
DE-D	100/101	KFA-V20	142	UFN	131
DLB	56	KFB-TM	136	UIB	128
DS	106	KFD-V20	141	V	
E		KFD-V40	143	VFB	146
ECB-N/ECE-N	59	KFE-TNM	138	VHB	147
EG-N/EW-N	40	KFN-TM	138	VHE-A	145
EMB	28	KFP-V20 IP65	140	W	
EMB-S	27	KFP-V20 IP67	141	WTB-N/WTB-NM	75
EMB-V	29	KFP-V30	142	Y	
EMS	30	KFP-V40	143	YKV-01	10
EOB/EOS	99	KFS-TM	136	YRO-01/-02/-03	169
EOC	102/103	KFU-V20	142		
EOE	98	KFU-V30	142		
EWJ	36	KGP	9		
F		KKP-V40	143		
FCB	62	KIB-TM	137		
FCE-N	60	KIP-V20M	141		
FCF	61	KTA-T	15/139		
FFN-N/FFN-NM	76	KTB-T	16/139		
FKB-A	63	KXP-V20 IP65	140		
FKB	65	KXS-TM	138		

1769
Ancestor Johann Jakob Sauter built the Hahn inclination scale out of iron, a foundation stone for weighing in the balance industry in Southern Germany

1844
KERN is founded – precision balances are produced

1863
A proud Gottlieb Kern with his staff

1880
Pharmaceutical balance with Aesculap

1923
Inflation – KERN wages are paid with self printed currency

1980
The electronic balance ousts mechanical devices

1994
Accredited DKD laboratory (ISO 17025)

2000
New premises in Balingen

2002
Existing QM system certification in accordance with DIN EN ISO 9001:2000 standards

2007
Approval for the manufacture of medical products (DIN EN 13485 and 93/42/EEC)

2008
Authorisation for initial verification by the manufacturer (2009/23/EC)

2009
Approval for the manufacture and sale of height rods (DIN EN 13485 and 93/42/EEC)

2012
Verification point for non-automatic balances and test weights.

2014
Expansion of the product range to include optical instruments (microscopes and refractometers)

2015
Inauguration of Ziegelei 2.0 with computer-controlled high-bay warehouse

2017
Come with KERN into the digital future: Expansion of the model ranges compatible with Industry 4.0, as well as the related services

2019
Significant anniversary year for KERN
25 years of accredited DKD Laboratory
175 years of KERN & SOHN
250 years of balance manufacture in the Sauter family-owned company

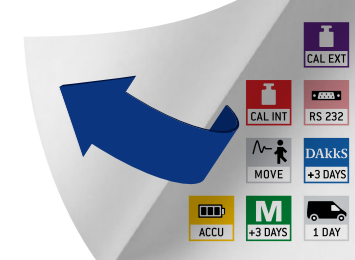

KERN Pictograms

 Internal adjusting: Quick setting up of the balance's accuracy with internal adjusting weight (motordriven)	 KERN Communication Protocol (KCP): It is a standardized interface command set for KERN balances and other instruments, which allows retrieving and controlling all relevant parameters and functions of the device. KERN devices featuring KCP are thus easily integrated with computers, industrial controllers and other digital systems	 Protection against dust and splashes IPxx: The type of protection is shown in the pictogram. For details see page 70
 Adjusting program CAL: For quick setting up of the balance's accuracy. External adjusting weight required	 GLP/ISO log: The balance displays serial number, user ID, weight, date and time, regardless of a printer connection	 Suspended weighing: Load support with hook on the underside of the balance
 Easy Touch: Suitable for the connection, data transmission and control through PC, tablet or smartphone	 GLP/ISO log: With weight, date and time. Only with KERN printers, see page 161/162	 Battery operation: Ready for battery operation. The battery type is specified for each device
 Memory: Balance memory capacity, e.g. for article data, weighing data, tare weights, PLU etc.	 Piece counting: Reference quantities selectable. Display can be switched from piece to weight	 Rechargeable battery pack: Rechargeable set
 Alibi memory: Secure, electronic archiving of weighing results, complying with the 2014/31/EU standard. For details see page 206	 Recipe level A: The weights of the recipe ingredients can be added together and the total weight of the recipe can be printed out	 Universal mains adapter: with universal input and optional input socket adapters for A) EU, CH B) EU, CH, GB, USA C) EU, CH, GB, USA, AUS
 Data interface RS-232: To connect the balance to a printer, PC or network	 Recipe level B: Internal memory for complete recipes with name and target value of the recipe ingredients. User guidance through display	 Mains adapter: 230V/50Hz in standard version for EU. On request GB, USA or AUS version available
 RS-485 data interface: To connect the balance to a printer, PC or other peripherals. Suitable for data transfer over large distances. Network in bus topology is possible	 Recipe level C: Internal memory for complete recipes with name and target value of the recipe ingredients. User guidance through display, multiplier function, adjustment of recipe when dosages are exceeded or barcode recognition	 Power supply: Integrated in balance. 230V/50Hz standard EU. More standards e.g. GB, USA or AUS on request
 USB data interface: To connect the balance to a printer, PC or other peripherals	 Totalising level A: The weights of similar items can be added together and the total can be printed out	 Weighing principle: Strain gauges Electrical resistor on an elastic deforming body
 Bluetooth* data interface: To transfer data from the balance to a printer, PC or other peripherals	 Percentage determination: Determining the deviation in % from the target value (100 %)	 Weighing principle: Tuning fork A resonating body is electromagnetically excited, causing it to oscillate
 WLAN data interface: To transfer data from the balance to a printer, PC or other peripherals	 Control outputs (optocoupler, digital I/O): To connect relays, signal lamps, valves, etc.	 Weighing principle: Electromagnetic force compensation Coil inside a permanent magnet. For the most accurate weighings
 Analogue interface: to connect a suitable peripheral device for analogue processing of the measurements	 Weighing units: Can be switched to e.g. nonmetric units at the touch of a key. See balance model. Please refer to KERN's website for more details	 Weighing principle: Single cell technology: Advanced version of the force compensation principle with the highest level of precision
 Interface for second balance: For direct connection of a second balance	 Weighing with tolerance range: (Checkweighing) Upper and lower limiting can be programmed individually, e.g. for sorting and dosing. The process is supported by an audible or visual signal, see the relevant model	 Verification possible: The time required for verification is specified in the pictogram
 Network interface: For connecting the scale to an Ethernet network	 Hold function: (Animal weighing program) When the weighing conditions are unstable, a stable weight is calculated as an average value	 DAKkS calibration possible (DKD): The time required for DAKkS calibration is shown in days in the pictogram
 Wireless data transfer: between the weighing unit and the evaluation unit using an integrated radio module	 Package shipment: The time required for internal shipping preparations is shown in days in the pictogram	 Pallet shipment: The time required for internal shipping preparations is shown in days in the pictogram

Der Name Bluetooth und die Logos sind eingetragene Warenzeichen und gehören der Bluetooth SIG, Inc.. Jedwede Verwendung dieser Warenzeichen durch die KERN & SOHN GmbH erfolgt unter Lizenz. Andere Warenzeichen oder Markennamen sind eingetragene Warenzeichen ihrer jeweiligen Besitzer.



Albert Sauter
Albert Sauter, Managing Director

We have a lot to celebrate this year:

250 years of balance manufacture in the Sauter family-owned company 175 years of KERN & SOHN

Companies with such a long tradition are rare. Time laps paired with efficiency but also fate write an exciting script. This is also true for us. Not only once the fate of the company was hanging by a thread. Even several times an early death in the Sauter family caused the succession of the company to falter. For one generation, the company's namesake – Gottlieb Kern – also stepped in as managing director. In 1844, the KERN brand was created, which his successor, Kommerzienrat Albert Sauter, was unable or unwilling to change.

Despite all the ups and downs, the construction of balances showed us a stable path – over 250 years to the present day in the eighth generation of the family.

We have only been able to find one family worldwide who, like us, has been active in the construction of balances for so long and without interruption. We have also been unable to find a workshop or company worldwide which, like us, has been manufacturing precision balances continuously for 200 years now.

This makes us the oldest manufacturer of precision balances in the world.

And our testing laboratory is also celebrating a juvenile, round birthday this year: a quarter of a century ago we were accredited as a DKD calibration laboratory!

But we don't want to rest on our laurels on these superlatives, and in our anniversary year we will again endeavour to present you with interesting new developments in the field of weighing technology.

Celebrate with us the year of the KERN anniversaries and be inspired by our many exciting products ...

175
KERN & SOHN
Balance manufacture in the Sauter family-owned company
250



KERN – measuring technology and testing services from a single source



Balances & Test service catalogue

Provides a complete overview of the KERN line of balances, test weights, and services such as verification, calibration, etc.

Medical scales catalogue

Complete line of medical scales, from infant scales to patient scales, chair scales and adiposity scales, as well as hand grip dynamometers, chemist's balances and veterinary scales.

Microscopes & refractometers catalogue

Extensive range in the area of optical instruments, such as, for example, biological microscopes, stereo microscopes, metallurgical microscopes, polarisation microscopes as well as analogue and digital refractometers.

SAUTER measuring equipment catalogue

Test instruments for industry and commerce, such as force, coating thickness, material thickness and calibration service.

DAKkS calibration service brochure

Detailed information on topics pertaining to the calibration and verification of balances, test weights, and force measuring devices.

Your advantages

fast

- 24 hours delivery service for products in stock – ordered today, on its way tomorrow
- Sales & service hotline available from 8:00 am to 6:00 pm

reliable

- Up to 3 years warranty
- Precision in weighing technology for more than 175 years

competent

- DAKkS accreditation DIN EN ISO/IEC 17025
- Certified QM system DIN EN ISO 9001
- Authorisation for initial verification by the manufacturer 2014/31/EU
- Medical certifications DIN EN ISO 13485 and 93/42/EWG

versatile

- One-stop shopping: from pocket balances through to 15 t crane balance – everything from one supplier
- Find the product you want at lightning speed with the "Balance Quick-Finder" at www.kern-sohn.com

 **Order hotline**
+49 7433 9933-0

 **Online Shop**
www.kern-sohn.com

 **Service hotline**
+49 7433 9933-199

 **E-mail order**
info@kern-sohn.com

 **Calibration hotline**
+49 7433 9933-196

 **Fax order**
+49 7433 9933-146

 **Our team of consultants will assist you**
from Monday to Friday
from 8:00 am to 6:00 pm

 **www.kern-sohn.com**
Information on current product availability, product data sheets, user instructions, useful knowledge, technical glossary, images and much for you to download, practical topic areas, which will guide you to the right product in your industry as well as a clever test weight and balance search engine.

Product group index 2019

NEW	01 System solutions Industry 4.0		8 – 11
NEW	02 Application solutions/Software		12 – 18
NEW	03 Pocket balances		19 – 21
NEW	04 Precision balances		22 – 42
NEW	05 Analytical balances		44 – 51
NEW	06 Moisture analysers		53 – 56
	07 Bench scales		57 – 69
NEW	08 Stainless steel/Protection against dust and water splashes IP65...68		70 – 79
	09 Price computing scales		80 – 83
	10 Counting scales/Counting systems		84 – 93
	11 Parcel scales/Platform scales		94 – 113
NEW	12 Floor scales/Pallet scales/Drive-through scales		115 – 133
NEW	13 Display devices/Platforms/Weighing bridges		134 – 143
	14 Pallet truck scales		144 – 147
NEW	15 Hanging scales/Crane scales		148 – 159
	16 Accessories		160 – 169
NEW	17 Test weights		170 – 193
	18 DAkkS Calibration Service and Verification service		194 – 205

Do you have questions about our products? Our customer consultants will be pleased to assist you:

FR, Maghreb, UK, IE



Maren Möwert

Tel. +49 7433 9933-132
Fax +49 7433 9933-29132
Mobil +49 151 46143240
maren.moewert@kern-sohn.com

DK, SE, FI, NO, PL, LV, LT, EE



Florian Bächle

Tel. +49 7433 9933-118
Fax +49 7433 9933-29118
Mobil +49- [0]151 44568364
florian.baechle@kern-sohn.com

GR, CY, BU, RO, SK, CZ, AL, Ex-Yugoslavia



Aleksandar Delić

Tel. +49 7433 9933-120
Fax +49 7433 9933-29120
Mobil +49 151 11196197
aleksandar.delic@kern-sohn.com

North America, Near- & Middle East, Africa, Asia, Oceania, TR



Corinna Klaass

Tel. +49 7433 9933-215
Fax +49 7433 9933-29215
Mobil +49 [0]151 44568364
klaass@kern-sohn.com

NL, Germany (CP 4)



Taras Mikitisin

Tel. +49 7433 9933-143
Fax +49 7433 9933-29143
Mobil +49 171 5590115
mikitisin@kern-sohn.com

GUS



Inna Wandler

Tel. +49 7433 9933-167
Fax +49 7433 9933-29167
Mobil +49 151 46143234
wandler@kern-sohn.com

HU, Germany (CP 5, 6)



Fabienne Kolbus

Tel. +49 7433 9933-305
Fax +49 7433 9933-29305
Mobil +49 171 3031168
fabienne.kolbus@kern-sohn.com

Board of Management



Albert Sauter

Tel. +49 7433 9933-157
Fax +49 7433 9933-29157
albert-sauter@kern-sohn.com

Sales Management



Ulrich Ulmer

Tel. +49 7433 9933-160
Fax +49 7433 9933-29160
Mobil +49 172 7423944
ulmer@kern-sohn.com

Deputy Sales Manager



Stephan Ade

Tel. +49 7433 9933-121
Fax +49 7433 9933-29121
Mobil +49 171 3060086
ade@kern-sohn.com

Marketing Management



Thomas Fimpel

Tel. +49 7433 9933-130
Fax +49 7433 9933-29130
fimpel@kern-sohn.com

Accountancy



Jutta Osswald

Tel. +49 7433 9933-215
Fax +49 7433 9933-149
jutta.osswald@kern-sohn.com

Technical Service



Markus Reinke

Tel. +49 7433 9933-190
Fax +49 7433 9933-195
reinke@kern-sohn.com



Edgar Litti

Tel. +49 7433 9933-193
Fax +49 7433 9933-195
litti@kern-sohn.com

DAkS Calibration Service



FR, BeNeLux, DK, TR, GR, Africa,
America, Oceania, DE (CP 8, 9),
Athina Ioakimidou

Tel. +49 7433 9933-123
Fax +49 7433 9933-29123
athina.ioakimidou@kern-sohn.com



GB, IE, FI, NO, S, AUS, ES, PT, IT,
DE (CP 5, 6, 7)
Sandra Ehinger

Tel. +49 7433 9933-162
Fax +49 7433 9933-29162
sandra.ehinger@kern-sohn.com



GR, TR, Eastern Europe, Baltic
States, CIS, South East Asia, AT, CH,
DE (CP 0, 1, 2, 3, 4)
Waldemar Fleitling

Tel. +49 7433 9933-163
Fax +49 7433 9933-29163
fleitling@kern-sohn.com

KERN PRODUCT SPECIALISTS

Your contact for technical questions

Pocket balances, school balances, pallet truck scales

**Fabienne Kolbus**

Tel. +49 7433 9933-305
Fax +49 7433 9933-29305
Mobil +49 171 3031168
fabienne.kolbus@kern-sohn.com

Precision balances

**Corinna Klaass**

Tel. +49 7433 9933-215
Fax +49 7433 9933-29215
Mobil +49- [0]151 44568364
klaass@kern-sohn.com

Analytical balances

**Christian D'Onofrio**

Tel. +49 7433 9933-147
Fax +49 7433 9933-29147
Mobil +49 151 46143234
christian.donofrio@kern-sohn.com

Moisture analysers

**Jesús Martínez**

Tel. +49 7433 9933-209
Fax +49 7433 9933-29209
Mobil +49 171 3059661
jesus.martinez@kern-sohn.com

Bench scales

**Edeltraud Semma-Hauser**

Tel. +49 7433 9933-140
Fax +49 7433 9933-29140
semma-hauser@kern-sohn.com

Protection against dust and water splashes IPx, price computing scales, hanging scales/crane scales

**Lisa Haiß**

Tel. +49 7433 9933-219
Fax +49 7433 9933-29219
lisa.haiss@kern-sohn.com

Counting scales/counting systems

**Bettina Schwedt**

Tel. +49 7433 9933-141
Fax +49 7433 9933-29141
Mobil +49 171 3059661
bettina.schwedt@kern-sohn.com

Parcel scales/platform scales, components

**Florian Bächle**

Tel. +49 7433 9933-118
Fax +49 7433 9933-29118
florian.baechle@kern-sohn.com

Test weights

**Sascha Skender**

Tel. +49 [0] 7433 9933 - 158
Fax +49 [0] 7433 9933 - 29158
sascha.skender@kern-sohn.com

Test services (DAkKS/Verification)

**Waldemar Fleitling**

Tel. +49 7433 9933-163
Fax +49 7433 9933-29163
fleitling@kern-sohn.com

Medical balances

**Hendrik Neff**

Tel. +49 7433 9933-161
Fax +49 7433 9933-29161
Mobil +49 171 3059946
hendrik.neff@kern-sohn.com

Optical devices

**Samuel Haasis**

Tel. +49 7433 9933-173
Fax +49 7433 9933-29173
samuel.haasis@kern-sohn.com

SAUTER Measuring technology

**Irmgard Russo**

Tel. +49 7433 9933-208
Fax +49 7433 9933-29208
russo@kern-sohn.com

Centre of expertise – Industry 4.0

**Consulting/hotline****connection of balances to networks**

Tel. +49 7433 9933-200
ITsupport@kern-sohn.com

NEWS

We also have lots of new models in our range for 2018

Industrial platform scale KERN KGP

Robust industrial platform scale with AD converter box, ideal for varied range of applications for Industry 4.0



Further details ▶ Page 9
from € 430,-

A/D converter box KERN YKV-01

Modern A/D converter for the rapid recording of weighing data and forwarding it to the most varied devices such as tablets, networks, PLC controllers, etc.



Further details ▶ Page 10
only € 190,-

Tablet KERN KTA-T

Multifunctional tablet for connection to digital platforms



Further details ▶ Page 15/139
only € 400,-

Tablet KERN KTB-T

Robust professional tablet for demanding weighing applications



Further details ▶ Page 16/139
only € 1290,-

Pocket balances KERN TGC

Slim pocket balance with large stainless steel weighing plate and practical tare pan



Further details ▶ Page 20
only € 99,-*
*Price set of 5 units excl. of VAT ex works

Pocket carat balance KERN TGD

Compact pocket carat balance for precision weighing of jewellery and precious stones



Further details ▶ Page 21
only € 260,-*
*Price set of 5 units excl. of VAT ex works

Precision balances KERN EMB-S

The space miracle – stackable school balance for experiment-based teaching



Further details ▶ Page 27
from € 180,-*
*Price set of 5 units excl. of VAT ex works

Analytical balance KERN ABP

Premium analytical balance with the latest Single-Cell Generation for extremely rapid, stable weighing results – the most rapid stabilisation time with the KERN analytical balance range



Further details ▶ Page 50/51
from € 1710,-

Moisture analyser KERN DAB

Moisture analyser which is particularly easy to use - now also as a version with [d] = 10 mg, ideal for recurring rapid tests

Note: both models also available as infrared version!

Further details ▶ Page 54
from € 930,-



Stainless steel bench scales KERN FOB/FOB-LM

Compact stainless steel bench scale with special, three-colour checkweighing display for even more efficient working

Further details ▶ Page 73
from € 175,-



Floor scales KERN BID/BID-D

Floor scale with EC type approval [M] and the best price-to-performance ratio - now also as a high-resolution dual-range scale

Further details ▶ Page 118/119
from € 1020,-

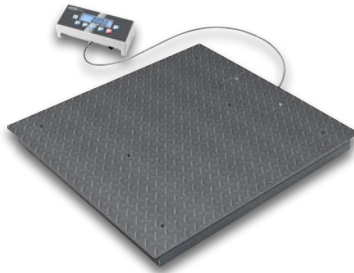

Luggage scale KERN HGA

Ultra compact, digital luggage scale for rapid weighing of items of luggage and other suspended loads

Further details ▶ Page 150
only € 80,-*

*Price set of 5 units excl. of VAT ex works



Crane scale KERN HCD

High-resolution hanging scale for loads up to 300 kg

Further details ▶ Page 153
from € 195,-



Test weights

A range of affordable test weights for all applications with robust aluminium boxes - the ideal combination for monitoring your measuring device. Price-optimised, practical, compliant!

Further details ▶ Page 170



01

System solutions Industry 4.0

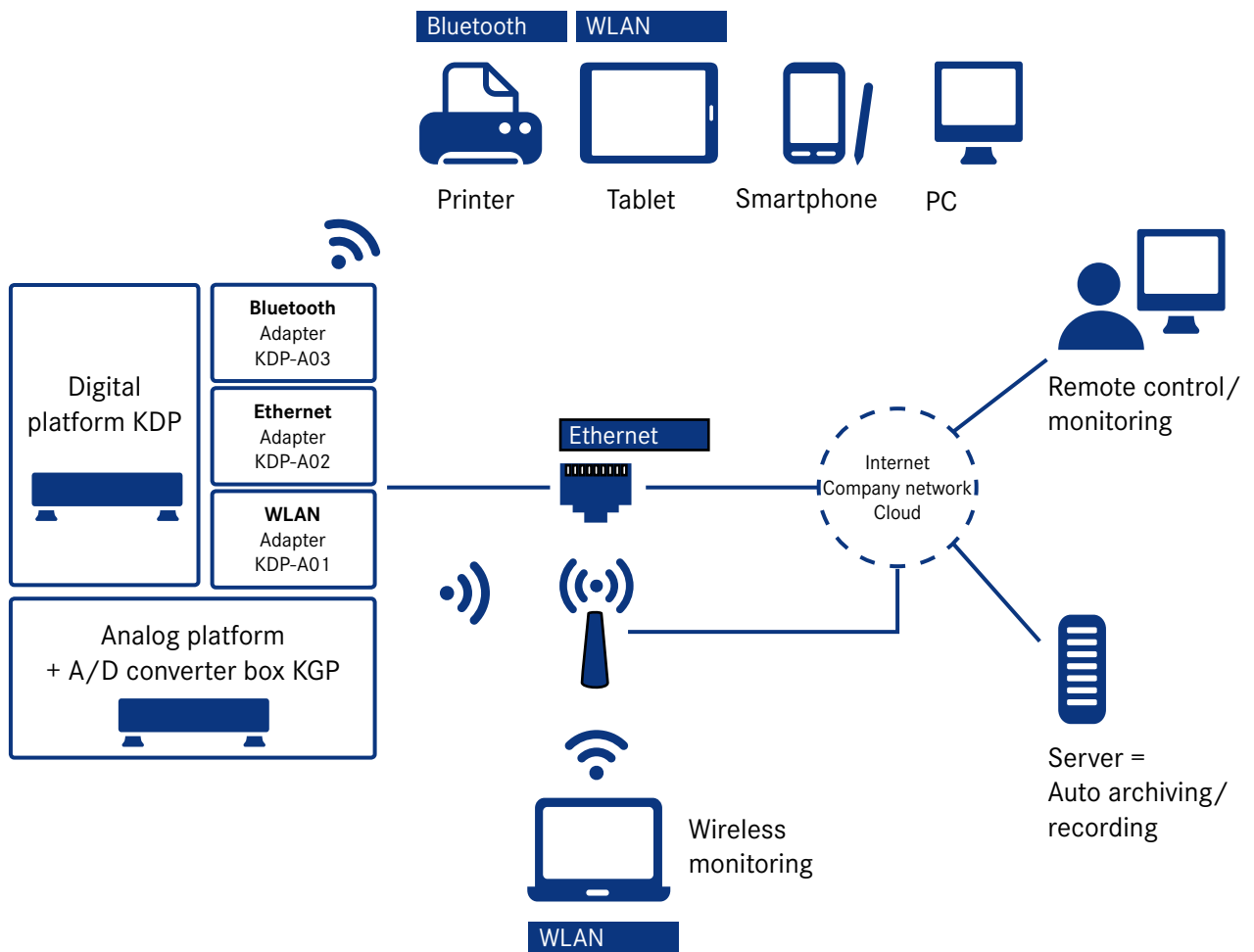

We will help to combine industrial production with the latest information and communication technology, with the aim of improving quality, reducing costs and using time and resources more efficiently so that you are able to react to future requirements in a more flexible manner. You will benefit from our uniform data protocol combined with our BalanceConnection 4.0 data software, for details please see page 13/14.

The KERN team in our centre of expertise – Industry 4.0



Daniel Egeler



Edgar Litti



Markus Reinke



Max Matthes



Stefan Rothmund

- We would like to inform you and advise you

Tel. +49 7433 9933-200
ITsupport@kern-sohn.com

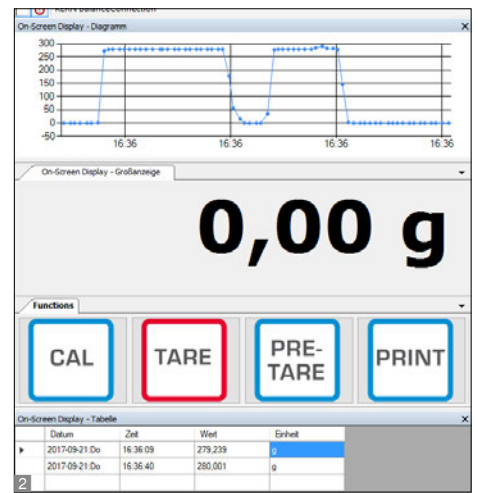
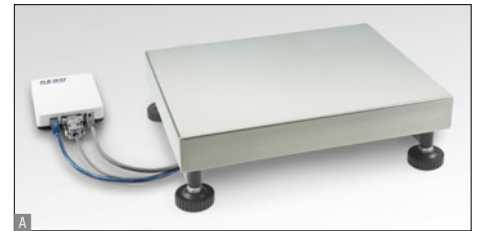

Robust industrial platform scale with A/D converter box, ideal for varied range of applications for Industry 4.0

Features

- With this combination of **1 platform (KERN KFP V20 IP65) and A/D converter box (KERN YKV-01)** your weighing processes are ready for the requirements of Industry 4.0. Simply install the platform, connect the A/D converter box to the network and start weighing
- For rapid transfer of weighing data to connected networks, computers, etc.
- USB and RS-232 data interface standard
- Transfer formats are freely configurable
- Many interface variants available
WiFi data interface, KERN YKV-01, € 60,-
Bluetooth data interface, KERN YKV-02, € 60,-
Other interfaces on request. A/D converter box with standard Ethernet data interface on request
- Functions: Weighing, taring

- Internal resolution 16 million divisions
- Measurement frequency 10 Mz
- Easy configuration using the software supplied
- KERN YKV-01: Robust plastic die-cast housing
- KERN YKV-01: Suitable for wall mounting and DIN track mount
- Included with delivery:
 - Industrial platform KERN KFP
 - A/D converter box KERN YKV-01
 - **2** Configuration software for adjusting and managing the KERN KDP, for large-format display of the values collected on the PC as well as transfer of this data to other Apps and programs. The displayed result can therefore be converted to any format for communication with the different user programs, such as, for example, e.g. SAP, Oracle etc.

Technical Data

- Weighing plate material stainless steel
- KERN YKV-01: Overall dimensions W×D×H 100×127×28 mm
- Permissible ambient temperature -10 °C/ 40 °C

Accessories

- **Software BalanceConnection**, flexible recording or transfer of measurements, particularly to Microsoft® Excel or Access as well as transfer of this data to other Apps and programs. The displayed result can therefore be converted to any format for communication with the different user programs, such as, for example, e.g. SAP, Oracle etc., for details see page 12, KERN SCD-4.0, € 150,-

STANDARD

CAL EXT | RS 232 | USB | KCP PROTOCOL | UNIT | IP 65 | DMS | 1 DAY

OPTION FACTORY

DAkkS +3 DAYS | BT 4.0 | WLAN

Model	Weighing capacity [Max] kg	Read-out [d] g	Weighing plate mm	Cable length m	Net weight approx. kg	Price excl. of VAT ex works €	Options	
							DAkkS KERN	DAkkS Calibr. Certificate €
KERN KGP 6K-4	6	0,2	300×240×120	3	6	430,-	963-128	88,-
KERN KGP 6K-4L	6	0,2	400×300×128	3	10	450,-	963-128	88,-
KERN KGP 10K-4	15	0,5	300×240×120	3	6	450,-	963-128	88,-
KERN KGP 10K-4L	15	0,5	400×300×128	3	10	490,-	963-128	88,-
KERN KGP 30K-3	30	1	300×240×120	3	6	450,-	963-128	88,-
KERN KGP 30K-3L	30	1	400×300×128	3	10	490,-	963-128	88,-
KERN KGP 60K-3	60	2	400×300×128	3	10	520,-	963-129	105,-
KERN KGP 60K-3L	60	2	500×400×137	3	13	580,-	963-129	105,-
KERN KGP 100K-3	150	5	500×400×137	3	14	580,-	963-129	105,-
KERN KGP 100K-3L	150	5	650×500×142	3	22	780,-	963-129	105,-
KERN KGP 300K-2L	300	10	650×500×142	3	22	780,-	963-129	105,-

NEW

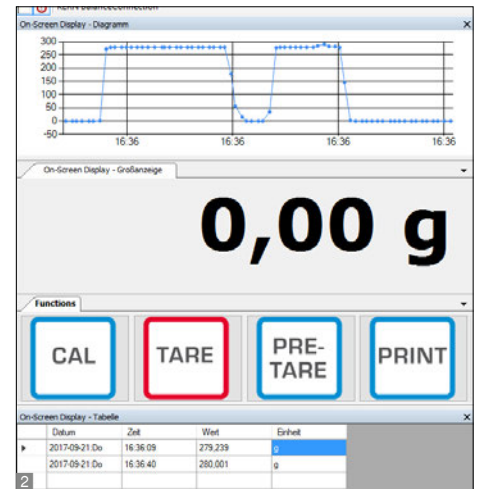

Modern A/D converter for the rapid recording of weighing data and forwarding it to the most varied output channels such as tablets, networks, SPS controllers, etc. – ideal for operating balances in systems or conveyors

Features

- With this A/D converter box your weighing processes are ready for the requirements of Industry 4.0. Simply connect a weighing platform or measuring cell, integrate the A/D converter box into the network and start weighing
- For rapid transfer of weighing data to connected networks, computers, etc.
- USB and RS-232 data interface standard
- Transfer formats are freely configurable
- Many interface variants available
- WiFi data interface, KERN YKV-01, € 60,-
- Bluetooth data interface, KERN YKV-02, € 60,-
- Other interfaces on request. A/D converter box with standard Ethernet data interface on request
- Functions: Weighing, taring
- Internal resolution 16 million divisions
- Measuring frequency 10 Hz
- Easy configuration using the software supplied

- Robust plastic die-cast housing
- 1 Suitable for wall mounting and DIN track mount
- Compatible with all KERN weighing platforms
- Included with delivery:
 - Industrial platform KERN KFP
 - A/D converter box KERN YKV-01
 - 2 Configuration software for adjusting and managing the KERN KDP, for large-format display of the values collected on the PC as well as transfer of this data to other Apps and programs. The displayed result can therefore be converted to any format for communication with the different user programs, such as, for example, e.g. SAP, Oracle etc.

Price excl. of VAT ex works,
KERN YKV-01, € 190,-

Technical Data

- Overall dimensions W×D×H 100×127×28 mm
- Net weight approx. 1,2 kg
- Permissible ambient temperature -10 °C/40 °C

Accessories

- **Software BalanceConnection**, flexible recording or transfer of measurements, particularly to Microsoft® Excel or Access as well as transfer of this data to other Apps and programs. The displayed result can therefore be converted to any format for communication with the different user programs, such as, for example, e.g. SAP, Oracle etc., for details see page 12, KERN SCD-4.0, € 150,-

STANDARD



FACTORY



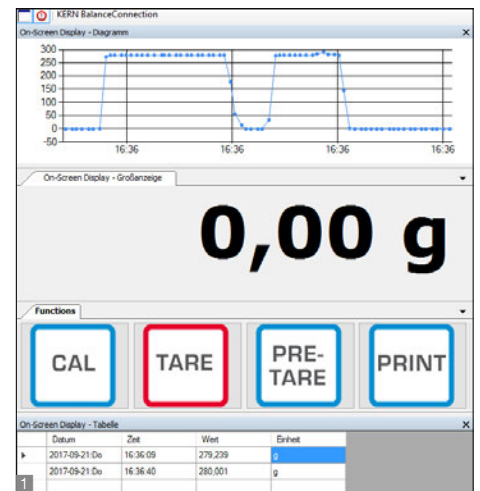

Universal weighing platforms for flexible connection into process chains

Features

- Industry 4.0 process chains: these weighing platforms can be easily integrated into your process chain. All recorded values can be easily transferred and processed further in your system as digital data and data that has already been compared using the many interfaces available. This saves cost, time and resources and ensures even more effective working
- Connecting the balance with a tablet or PC offers the advantage of being able to use the apps and programs which are on that device. These apps and programs are usually already tailored to your needs, are easy and convenient to use and can often be expanded as needed. This offers you the maximum level of flexibility when displaying, processing and saving the recorded weighing data
- **Searching and remote control of the balance** using external control devices or computers with the KERN Communication Protocol (KCP). KCP is a standardised interface command structure for KERN balances and other instruments which allows you to recall

and manage all relevant parameters and device functions. You can therefore simply connect KERN devices with KCP to computers, industrial control systems and other digital systems. In a large number of cases the KCP is compatible with the MT-SICS protocol

- **PRE-TARE function** for manual subtraction of a known container weight, useful for checking fill-levels
- **Freely programmable weighing unit**, e.g. display direct in special units such as length of thread g/m, paper weight g/m², or similar
- **Level indicator and levelling feet** for precise levelling of the scale, fitted as standard, to give the most accurate weighing result
- **Draught shield** standard for models with weighing plate size **A**, weighing space W×D×H 146×146×80 mm
- Included with delivery:
 - **Software BalanceConnection** for adjusting and managing the KERN KDP, for large-format display of the values collected on the PC as well as transfer of this data to other Apps and programs

Technical Data

- Dimensions weighing surface
 - A** Ø 105 mm
 - B** WxD 160×160 mm, see larger picture
- Weighing plate material
 - A** plastic, with conductive lacquer
 - B** stainless steel
- Overall dimensions W×D×H 165×166×75 mm (without draught shield)
- Cable length approx. 1,2 m
- Net weight approx. 1,2 kg
- Permissible ambient temperature 5 °C / 35 °C

Accessories

- **Bluetooth data interface** for wireless data transfer to PC or tablets, must be ordered at purchase, KERN KDP-A03, **€ 70,-**
- **WiFi interface** for wireless connection of the balance to networks and WiFi capable devices, such as tablets, laptops or smartphones, must be ordered at purchase, please ask for delivery time, KERN KDP-A01, **€ 70,-**

STANDARD						OPTION		FACTORY	
CAL EXT	USB	KCP PROTOCOL	MULTI	DMS	1 DAY	DAkkS +3 DAYS	BT 4.0	WLAN	

Model	Weighing capacity [Max] g	Read-out [d] g	Reproducibility g	Linearity g	Weighing plate mm	Price excl. of VAT ex works €	Options	
							DAkkS KERN	DAkkS Calibr. Certificate €
KDP 300-3	350	0,001	0,002	± 0,005	A	390,-	963-127	72,-
KDP 3000-2	3500	0,01	0,02	± 0,05	B	390,-	963-127	72,-
KDP 10K-4	10000	0,1	0,1	± 0,3	B	390,-	963-128	88,-
KDP 10K-3	10000	1	1	± 3	B	390,-	963-128	88,-

Application solutions/Software

Increased efficiency is the key to greater success in ever tightening markets

This inevitably leads to increased pressure on employees in laboratories, clinics, industrial or service companies – more and more tasks must be carried out in less and less time. Often, this can only happen if it is possible to automate processes either in part or fully.

For the area of full automation, we have developed products which can be integrated easily and discretely into your process chains, see Product group 01 “System solutions for Industry 4.0” on pages 8–11.

In Product group 02 “Application solutions/Software” we focus on supporting users of measuring and weighing technology, with the aim of helping them carry out their tasks more rapidly, more efficiently and even more accurately than before.

To do this we process the measuring and weighing data which has been collected digitally and transfer it to the relevant software applications in the right format for that particular user, i.e. the user software receives the measuring and weighing data in the format required for processing. To do this, as well as powerful hardware components, we use the KERN BalanceConnection multi-function software, which, in its PRO version, has been further enhanced to give an even greater range of functions. The competent team from our “Industry 4.0 centre” of expertise will be happy to help you integrate your KERN balances.

In a further step we offer users of KERN balances a wealth of EasyTouch Apps, which shapes the user-specific application into an intuitive workflow and thus guides you through the process, efficiently and reliably. This applies to chemical or biological laboratory tests just as it does to industrial and production processes in manufacturing industries or in the manufacture of food products or pharmaceutical products.

The KERN EasyTouch Apps in combination with the relevant hardware, such as, for example, with a Smartphone, tablet or PC and a balance, make your apparently simple balance into a high-tech instrument with integrated workflow and database software, which works in conjunction with other balances, network systems and database servers.

This modular software/hardware architecture creates extremely efficient weighing systems, which are customised to your own particular requirements and which can grow with you and your increasing requirements. Ask the team from our “Industry 4.0 centre of expertise”, they will be happy to help you with any questions related to application solutions/software.



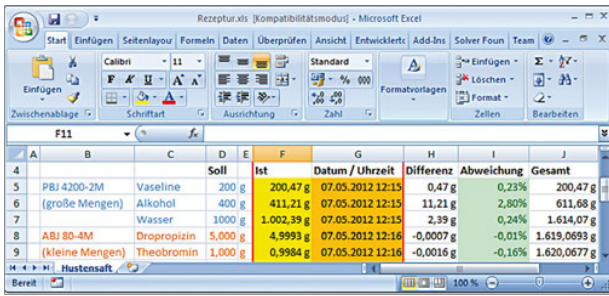

Easy transfer and editing of measuring results e.g. in Microsoft® Excel

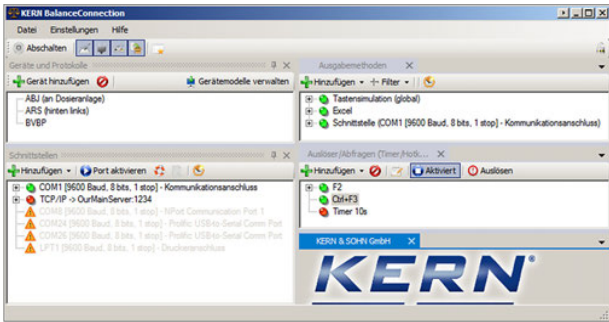

Full overview of devices, outputs, queries, interfaces, etc. shown on the output window immediately.

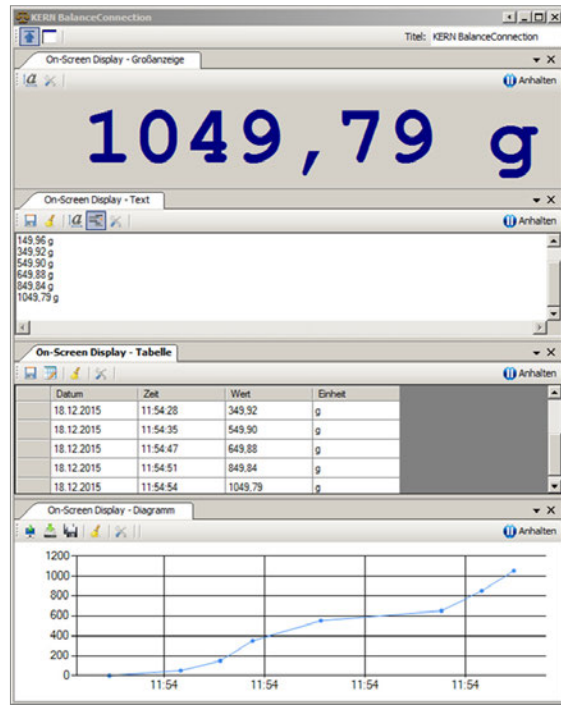

Different on-screen displays with export function

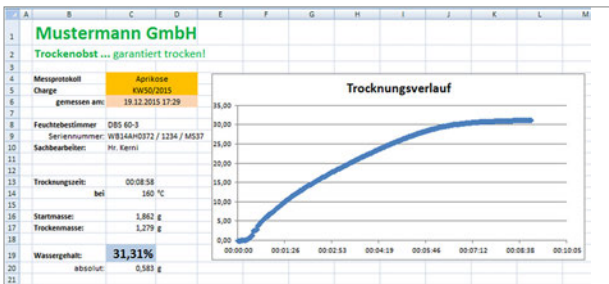

Measurement report with line chart showing a moisture analysis

Note

Do you have any questions? The team from our Industry 4.0 centre of expertise will be happy to help:
e-mail: ITsupport@kern-sohn.com

Flexible recording or transfer of measurements, particularly to Microsoft® Excel or Access

Features

- For operating systems Windows XP, Vista, 7, 8, 8.1, 10
- Supports balances measuring devices with RS 232, RS 485, Bluetooth, LAN or WLAN network (TCP/UDP/IP)
- Highly flexible formatting of the output (any order, formatting and rounding), particularly recording of date and time for every value transferred, if required
- Any number of devices/interfaces can be connected, as well as simultaneous and synchronised recording of several balances
- Key-activated or time-controlled interrogation of measurements or trigger of device functions, also for continuous recording
- The interface protocols for KERN balances are already predefined (standard configuration)

- Compatible interface cable included when you order a KERN balance at the same time
- Many different transfer and recording options:
 - Microsoft® Excel/Access/Word in the foreground or background
 - Other Windows applications (through key simulation), e.g. shipping software or ERP system (SAP, Sage, etc.)
 - File recording (e.g. as text or CSV file)
 - Print out on text or label printer
 - Screen output such as large display, line chart (drying curve for moisture analyzer), histogram, etc.

Benefits

- Typing errors during e.g. manual transfer are avoided
- Automatic recording, e.g. for long-term tests
- GLP-compliant lab software
- Can be used across different branches and applications
- Also available as a cost-optimised package with 5 licenses, **you save more than 30 %!**
- Also available immediately as a download license
- Scope of supplies: 1 CD, 1 license, KERN SCD-4.0, **€ 150,-**
- Scope of supplies: 1 CD, 5 licenses, KERN SCD-4.0-S05, **€ 500,-**
- Scope of supplies: Download link for 1 license, KERN SCD-4.0-DL, **€ 150,-**

NEW

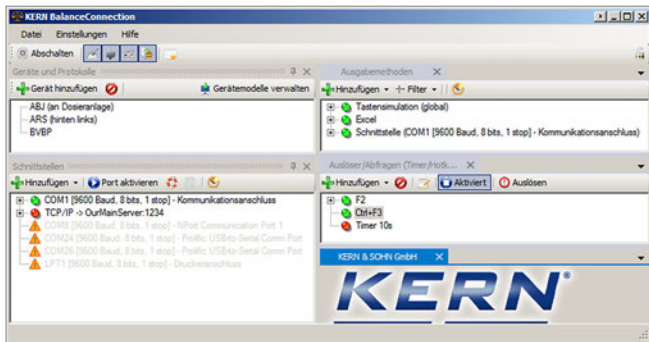
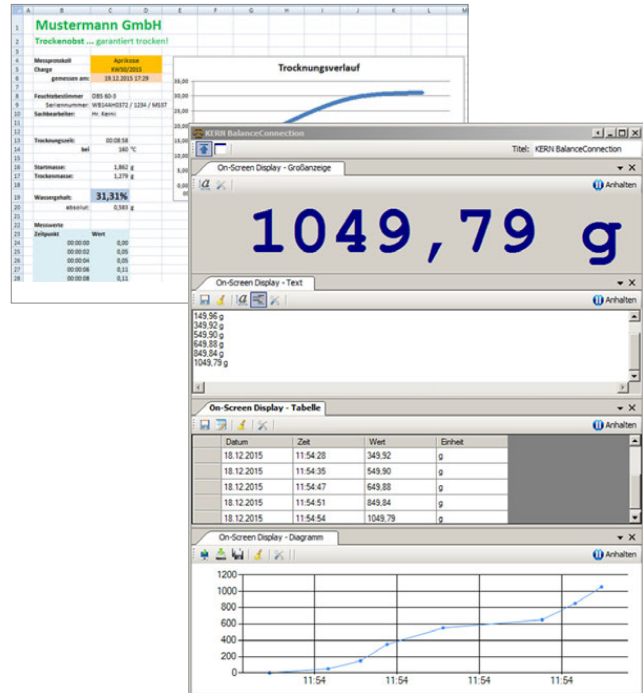
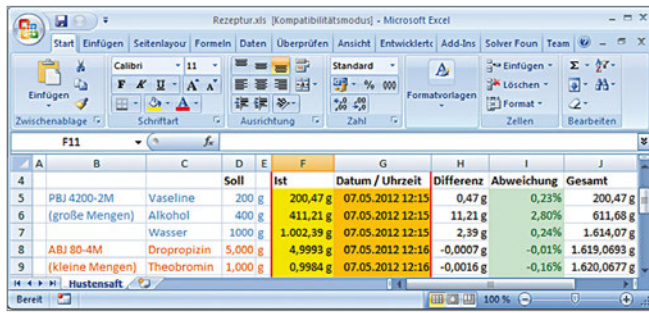

Professional and highly flexible recording or transmission of measured values, in particular also to Microsoft® Excel or Access

Features

- For operating systems Windows XP, Vista, 7, 8, 8.1, 10
- Supports balances measuring devices with RS 232, RS 485, Bluetooth, LAN or WLAN network (TCP/UDP/IP)
- Highly flexible formatting of the output (any order, formatting and rounding), particularly recording of date and time for every value transferred, if required
- Any number of devices/interfaces can be connected, as well as simultaneous and synchronised recording of several balances
- Key-activated or time-controlled interrogation of measurements or trigger of device functions, also for continuous recording
- The interface protocols for KERN balances are already predefined (standard configuration)
- Compatible interface cable included when you order a KERN balance at the same time
- Many different transfer and recording options:
 - Microsoft® Excel/Access/Word in the foreground or background
 - Other Windows applications (through key simulation), e.g. shipping software or ERP system (SAP, Sage, etc.)
 - File recording (e.g. as text or CSV file)
 - Print out on text or label printer
 - Screen output such as large display, line chart (drying curve for moisture analyzer), histogram, etc.

Additional features of the BalanceConnection PRO version:

- ODBC/SQL databases such as SQL Server or MySQL
- Transfer to HTTP Webservices/Web forms
- Histogram
- Enables the connection of medical balances to practice EDP systems using the device data transfer protocol (GDT) and also the HL7 protocol
- Implementation of programs/scripts using freely-definable command lines
- Command sequences
- Defining the conditions for specific events and the reaction to these events
- Filter for stability recognition (configurable value storage)
- Central configuration repository, e.g. on the network
- On-screen displays with configurable user interface for flexible balance operation

Benefits

- Ideal software where weighing data which has been collected needs to be transferred to a Windows PC
- Particularly suitable for professional integration of weighing systems into existing networks where there is a high demand for automated data transfer and further processing, for integration of databases
- Automatic recording, e.g. for long-term tests
- GLP-compliant lab software
- Can be used across different branches and applications
- Also available as a cost-optimised package with 5 licenses, **you save more than 30 %!**
- Also available immediately as a download license
- Scope of supplies: 1 CD, 1 License
KERN SCD-4.0-PRO, € 290,-
- Scope of supplies: 1 CD, 5 Licenses
KERN SCD-4.0-PRO5, € 990,-
- Scope of supplies: Download link for 1 License, KERN SCD-4.0-PRO-DL, € 290,-

NEW

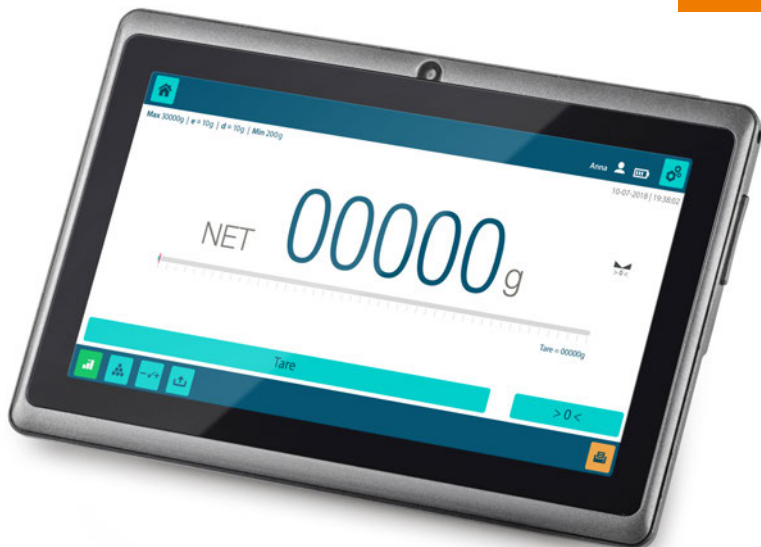

02

KERN KTA-T, € 400,-
(on request)

KERN KTA-T – Multifunctional tablet for connection to digital platforms, balances, measuring cells

Convert your balance into a computer!

This modern tablet transforms your weighing components into a powerful measuring system with a wide variety of analysis options in an instant. Simply download the appropriate app on the tablet and process the weighing data according to your ideas. Thanks to this modular concept, the initial investment is kept to a minimum and, at the same time, offers you a high level of investment security and future reliability. If your requirements should increase or your area of work should expand, then simply download more Apps. In this way the investment remains predictable and you do not pay for functions which you do not need – pretty smart!

Features

- Ideal for use in the laboratory environment, industry, test laboratories, etc., either as permanently fixed large display for one balance or as mobile display for one or more scales using WLAN or Bluetooth
- **1** Compact, slim tablet
- Superior display size in comparison with a standard display on a balance
- Separate connection for power supply, so, when charging, the USB connection remains free for USB sticks, peripheral devices, etc.
- MicroUSB to connect peripheral devices, can also be used for power supply
- For further information and extensive accessories, please see www.kern-sohn.com/de/KTA-T

Accessories

- **2** Aluminum tablet stand, infinitely adjustable in inclination for ergonomic reading and operation of the tablet, the tablet can be set upright and transversely, rubberized contact points ensure a non-slip grip and protect the tablet, W×D×H 100×35×85 mm, KERN YKD-A03, **€ 20,-**

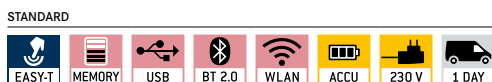

NEW

02



KERN KTB-T, € 1290,-
(on request)



KERN KTB-T – Robust professional tablet for demanding weighing applications

Convert your balance into a computer!

This modern tablet transforms your weighing components into a powerful measuring system with a wide variety of analysis options in an instant. Simply download the appropriate app on the tablet and process the weighing data according to your ideas. Thanks to this modular concept, the initial investment is kept to a minimum and, at the same time, offers you a high level of investment security and future reliability. If your requirements should increase or your area of work should expand, then simply download more Apps. In this way the investment remains predictable and you do not pay for functions which you do not need – pretty smart!

Features

- Ideal for use in the laboratory environment, pharmaceutical field, industry, test laboratories, etc., either as permanently fixed large display for one balance or as mobile display for one or more scales using WLAN or Bluetooth
- Wide range: can be connected to a variety of balances, from the analytical balance to the floor scale, thus particularly comfortable management of the weighing systems used
- High-quality industrial tablet
- Superior display size in comparison with a standard display on a balance
- 1 Separate connection for power supply, so, when charging, the USB connection remains free for USB sticks, peripheral devices, etc.
- A large number of standard integrated interfaces allow the parallel connection of peripheral devices, storage media, network connections, etc.
- 2 Octopus cable as standard, allows the parallel connection of up to 5 peripheral devices, networks, etc. with only one interface

- MicroUSB for connecting peripheral devices as well as integrated VESA mounting preparation for mounting the tablet to a wide variety of standard mounts, tripods etc. as standard
- For further information and extensive accessories, please see www.kern-sohn.com/de/KTB-T

STANDARD

EASY-T	RS 232	USB	BT 2.0	WLAN	LAN	GLP	IP 64	230 V	1 DAY
--------	--------	-----	--------	------	-----	-----	-------	-------	-------

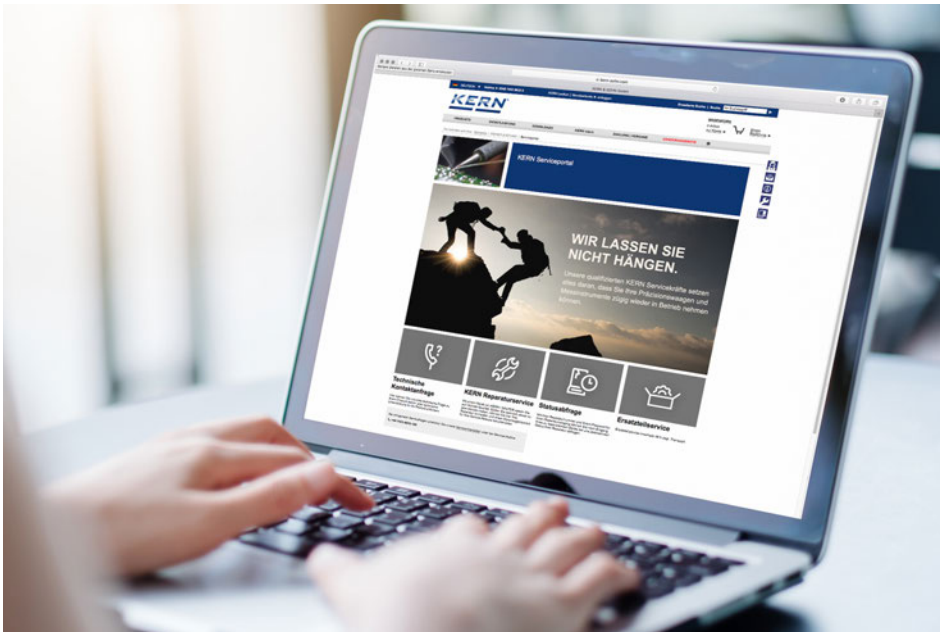

KERN Service Portal

[www.kern-sohn.com/
serviceportal](http://www.kern-sohn.com/serviceportal)

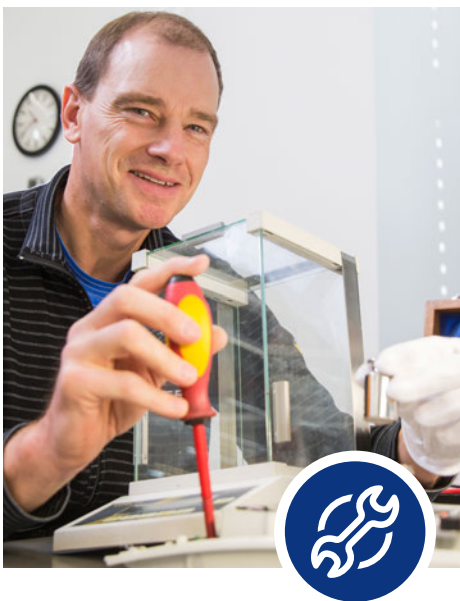

Technical contact enquiries this is where you can ask us a technical question about your product or request technical support for your product



Fast service
We deliver needed spare parts usually within 48 hours plus transport



At any time **status inquiry** from your device with your repair number and your password for your repair process

The KERN Service Portal – We won't let you down!

With a device from KERN you can be sure of the highest quality. But if you have any complaints at all, you can register your repair at www.kern-sohn.com/serviceportal and download a consignment note for your service return.

Your advantages: Accelerated processing as well as online tracking of the repair status. Our reliable KERN service personnel will do everything within their power to make sure your precision balances and measuring devices are back in operation as quickly as possible.

KERN scales and components with KCP

Aim & advantages:

Searching and remote control of the balances using external control devices or computers with the KERN Communication Protocol (KCP).

KCP is a standardised interface command structure for KERN balances and other instruments which allows you to recall and manage all relevant parameters and device functions.

You can therefore simply connect KERN devices with KCP to computers, industrial control systems and other digital systems. In a large number of cases the KCP is compatible with the MT-SICS protocol.

KERN models with KCP:



A/D converter KERN YKV-01

Modern A/D converter for the rapid recording of weighing data and forwarding it to the most varied output channels such as tablets, networks, controllers, etc.

Further details ► Page 10



Digital platform KDP

Universal weighing platforms for flexible connection in process chains

Further details ► Page 11



laboratory balance PFB

Quick-displaying precision balance, now with larger housing for more secure footing

Further details ► Page 34



Bench scale GAT

KERN Easy-Touch bench scale – the intuitive way to weigh

Further details ► Page 68/69



Platform scale EOC

Robust and high-resolution platform scale with practical Flip/Flop display device for greatest ease of use

Further details ► Page 102/103



Platform scale IOC

All-round platform scale with a range of communication options and EC type approval [M]

Further details ► Page 104



Platform scale IFT

KERN Easy-Touch platform scale – the intuitive way to weigh

Further details ► Page 112/113

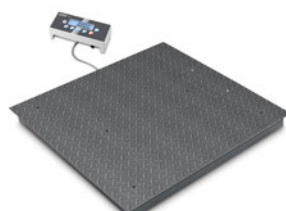

Floor scale BID

Floor scale with EC type approval [M] and the best price-performance ratio

Further details ► Page 118/119



Display device KIB-TM

Practical Flip/Flop display device for greatest ease of use

Further details ► Page 137































Pocket balances

Pocket size precision

Pocket balances are the ideal helpers whenever mobility and high precision are required. Since they have fewer keys, operation is simple and fast. Different weighing units stored in the pocket balance, such as g, oz, ct, gn, etc., make them universally usable. An integrated calculator allows you to use the measured weight immediately in calculations, to e.g. determine a price, quantity, average value and much more. Compact in size and well protected with a flap or protective cover, which can be used as a convenient taring container, the pocket balance is always a useful tool for mobile weighing.

- In production, to control of production weights or during the picking of small parts
- In quality control for the quick testing of small parts like plastic parts from injection moulding machines, milled parts, screws, etc.
- For mobile weighing, on-site sampling, and fast analysis wherever there's no power outlet
- In hobbies and sports, e.g. when filling black powder, weighing parts from modelling kits etc.
- In commerce, for the fast determination of the weights of coins, jewellery, precious stones, etc.
- In veterinary sector for the weighing of small animals, the mixing of food, etc.
- In the food sector for the preparation of spice or tea mixes, for the weighing of food in line with a diet sheet.

Quick-Finder Pocket balances

Readability [d] g	Weighing capacity [Max] g	Model KERN	Price excl. of VAT ex works €	Page			
0,001	20	TAB 20-3 	75,-	21	1		
0,001	50	TGD 50-3CS05 	260,-*	21	1		
0,002	10	CM 50-C2N 	90,-	21	1		
0,01	60	CM 60-2N	79,-	20	1		
0,01	150	TGC 150-2S05	99,-*	20	1		
0,1	150	TEE 150-1	38,-	20	1		
0,1	150	CM 150-1N	50,-	20	1		
0,1	200	TCB 200-1	52,-	20	1		
0,1	320	CM 320-1N	55,-	20	1		
0,1	500	TGC 500-1S05	99,-*	20	1		
1	1000	CM 1K1N	52,-	20	1		
1	1000	TGC 1K-3S05	99,-*	20	1		

News 2019

*Price set of 5 units

 = Carat balances

 = standard

 = option

Fabienne Kolbus

Product specialist Pocket balances

Tel. +49 7433 9933-305

Fax +49 7433 9933-29305

fabienne.kolbus@kern-sohn.com



HIGHLIGHT

*Price set of 5 units excl. of VAT ex works



only €
99,-*

- Simple and convenient 4-key operation
- Backlit LCD display
- Cover can also be used as a tare cup
- Also ideal as a gift for your customers



NEW

5x

KERN TEE

Designer pocket balance at a bargain price

KERN TCB

This is where the fun starts with pocket format weighing

KERN CM

Pocket balance with integrated pocket calculator

KERN TGC

Slim pocket balance with large stainless steel weighing plate and practical tare pan

STANDARD

CAL EXT UNIT BATT 1 DAY

STANDARD

CAL EXT UNIT BATT 1 DAY

STANDARD

CAL EXT UNIT BATT 1 DAY

STANDARD

CAL EXT UNIT BATT 1 DAY

OPTION

DAkKS +3 DAYS

OPTION

DAkKS +3 DAYS

OPTION

DAkKS +3 DAYS

OPTION

DAkKS +3 DAYS

- Simple and convenient 2-key operation
- Cover made of shock proof plastic as protection against pressure and dust. Can also be used as a tare cup

- Simple and convenient 2-key operation
- Small and handy
- Transport box and weighing pan included
- Revolving weighing plate (as overload protection)

- Hard case cover as protection against pressure and dust
- Integrated calculator

- High-resolution pocket balance with particularly rapid reaction and stabilisation time, which means that you can work extremely efficiently
- Particularly flat design
- Cover made of shock proof plastic as protection against pressure and dust. Can also be used as a tare cup
- Stainless steel weighing plate, which makes cleaning easy and hygienic
- Note: The models are only delivered in a set of 5 units. i.e. the prices given in the table refer to a delivery of 5 items. Cannot be delivered individually. The calibration prices given here refer to calibration of a single balance

Tip: KERN pocket scales are also ideal as a customer gift or for personalized marketing and sales campaigns. We are happy to print your logo on the cover, the lid or the packaging, from 100 pieces. Please inquire details

KERN	TEE 150-1	TCB 200-1	CM 60-2N	CM 150-1N	CM 320-1N	CM 1K1N	TGC 150-2S05	TGC 500-1S05	TGC 1K-3S05
Weighing capacity [Max] g	150 g	200 g	60 g	150 g	320 g	1000 g	150 g	500 g	1000 g
Readability [d] [d]	0,1 g	0,1 g	0,01 g	0,1 g	0,1 g	1 g	0,01 g	0,1 g	1 g
LCD display	backlit, digit height 9 mm	Digit height 9 mm	Digit height 12 mm			backlit, digit height 12 mm			
Dimensions of weighing plate	W×D 60×64 mm	ø 80 mm	W×D 70×80 mm			ø 81 mm			
Overall dimensions	W×D×H 67×100×22 mm	ø×H 80×14 mm	W×D×H 85×130×25 mm			W×D×H 100×130×18 mm			
Power supply	Batteries included, 2×1,5 V AAA, operating time up to 50 h	Batteries included, 2×LR 44, AUTO-OFF function to preserve battery life, can be switched off	Batteries included, 2×1,5 V AAA, AUTO-OFF function to preserve battery life, can be switched off			Batteries included, 2× CR2032, operating time up to 33 h			
			Operating time:						
			ca. 30 h	ca. 70 h	ca. 30 h	200 g			
Net weight	100 g	50 g	180 g			0 °C/40 °C			
Permissible ambient temperature	5 °C/35 °C								
Price € , excl. of VAT, ex works	38,-	52,-	79,-	50,-	55,-	52,-	99,-*	99,-*	99,-*
Option DAkKS Calibr. Certificate	963-127, 72,-								

NEW New model

Price reduction

*Price set of 5 units excl. of VAT exworks



KERN CM-C

Pocket balance with carat display – ideal for jewellers

KERN TAB

High-precision pocket carat balance for jewellers and travelling salesmen

KERN TGD

Compact pocket carat balance for precision weighing of jewellery and precious stones

STANDARD

- CAL EXT
- UNIT
- BATT
- 1 DAY

STANDARD

- CAL EXT
- UNIT
- BATT
- 1 DAY

STANDARD

- CAL EXT
- UNIT
- BATT
- 1 DAY

OPTION

- DAkKS +3 DAYS

OPTION

- DAkKS +3 DAYS

OPTION

- DAkKS +3 DAYS

- Hard case cover as protection against pressure and dust
- Hard case cover as protection against pressure and dust
- Adjusting weight standard
- Draft shield against air movements standard
- Weighing pan standard

- Simple and convenient 4-key operation
- Can be switched over from g to ct, gn at the touch of a key
- Hard case cover as protection against pressure and dust
- Adjusting weight and weighing pan standard

- Simple and convenient 4-key operation
- Can be switched over from g to ct, gn, dwt, ozt, oz at the touch of a key
- Innovative touchscreen: Large touch-sensitive, backlit touch display with very good contrast for easy operation and convenient reading
- Hard case cover as protection against pressure and dust
- Stainless steel weighing plate, which makes cleaning easy and hygienic
- Weighing pan standard
- USB cable for power supply as standard
- 1 Delivered in appealing packaging
- **Note:** The models are only delivered in a set of 5 units. i.e. the prices given in the table refer to a delivery of 5 items. Cannot be delivered individually. The calibration prices given here refer to calibration of a single balance

Tip: KERN pocket scales are also ideal as a customer gift or for personalized marketing and sales campaigns. We are happy to print your logo on the cover, the lid or the packaging, from 100 pieces. Please inquire details

KERN	CM 50-C2N	TAB 20-3	TGD 50-3CS05 NEW
Weighing capacity [Max] g	10 g 50 ct	20 g 100 ct	50 g 250 ct
Readability [d] [d]	0,002 g 0,01 ct	0,001 g 0,005 ct	0,001 g 0,005 ct
LCD display	Digit height 9 mm	backlit, digit height 9 mm	backlit, digit height 12 mm
Dimensions of weighing plate	W×D 50×40 mm	W×D 36×42 mm	ø 65 mm
Overall dimensions	W×D×H 85×130×25 mm	W×D×H 95×133×33 mm	W×D×H 96×149×36 mm
Power supply	Batteries included, 2×1,5 V AAA, AUTO-OFF function to preserve battery life, can be switched off, operating time up to 30 h	Batteries included, 4×1,5 V AAA, operating time up to 150 h without backlight	
Net weight	200 g		
Permissible ambient temperature	5 °C/35 °C	10 °C/30 °C	5 °C/35 °C
Price €, excl. of VAT, ex works	90,-	75,-	260,-*
Option DAkKS Calibr. Certificate	963-127, 72,-		

NEW New model

*Price set of 5 units excl. of VAT exworks

04

Precision balances

Here you'll find a complete summary of the KERN laboratory scales series and their positioning within the precision scales segment on the basis of application, price-performance ratio and functional volume

PREMIUM LABORATORY BALANCES

			★★
			★★
			★
			





STANDARD LABORATORY BALANCES

					★★
					★★
					★
					

BASIC LABORATORY BALANCES

									★★★
									★★
									★
									

SCHOOL BALANCES

					★★★
					★★
					★
					



Corinna Klaass

Product specialist Precision balances

Tel. +49 7433 9933-215

Fax +49 7433 9933-29215

klaass@kern-sohn.com

HIGHLIGHT



from €
36,-*

- The space miracle
- Stackable school balance for experiment-based teaching
- now also as high resolution version with 10 mg readability
- Simple and convenient 2-key operation

Precision balances

KERN school balances

are entry-level devices in the field of laboratory balances, and they cover basic applications. They feature simple operation and the very best price/performance ratio. In addition they can be stacked and can also be operated by battery, as an alternative to mains power, which means that they have the flexibility to be used in different locations.

KERN Basic laboratory balances

are used in laboratory applications mostly as single-user balances for sample preparation, etc. They are fitted with all useful laboratory functions which will support the user in a helpful way. With their strain gauge measuring principle, they are used anywhere where individual weighings are carried out, such as, for example, checkweighing. These devices are often connected to printers or local PCs using the standard, integrated RS-232 data interface.

KERN Basic standard laboratory balances

offer you all the tools you would need for effective and accurate work in your laboratory environment. All important laboratory functions such as a recipe weighing function or data interfaces are on board at all times. But above all, the high-quality measuring principles of these balances such as force compensation or tuning fork measuring principle, allow them to be used in dosing procedures with very small weight changes and rapid display. In addition these balances are often fitted with automatic internal adjustment, which permits calibrated operation and means the balance can be used in any location.

KERN premium laboratory balances

are right at the top of the precision balance segment. The numerous equipment features of the standard balances are complemented by high-quality materials with robust, sturdy construction, high-quality, high-performance weighing systems, optimised operating sequences, speed benefits and in some cases, the most modern touchscreen technology. With its touchscreen technology a premium laboratory balance will support your users in their typical procedures. In this way these scales can be operated more efficiently and quickly than devices from other quality classes. In particular these balances are used in demanding laboratory applications and anywhere where the environmental conditions are not ideal because of vibrations or other interference, but where, naturally, the balance is expected to provide accurate weighing results. Another field of application for these balances is the pharmaceutical industry, which is subject to particularly demanding requirements and regulations such as, for example, the FDA (Food and Drug Administration).

In order to make it easier for you to make the right choice of KERN balance, we have included a quality code for each model, which is made up of two quality features and will give you technical data and pictograms in addition to the product features. This will help you to make the decision on the perfect balance for your application:

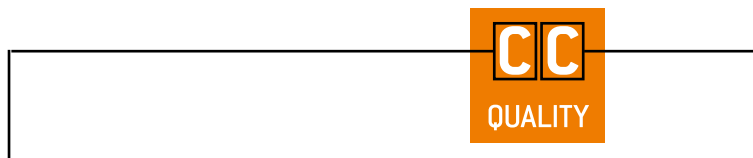

The stability quality feature

How quickly and sensitively weighing results are displayed? This quality feature on the basis of the information on the housing material and total weight of the balance, the stability quality feature gives you an indication of the types of application for which the balance is particularly well-suited. Due to their low weight, materials such as plastic allows structures which are particularly advantageous for mobile applications. The appeal of models which are used to process high-quality, heavy material, such as, for example, aluminium casting or steel, is their durability and robustness and the fact that they are less susceptible to vibrations. A high level of stability allows rapid, repeatable weighing results. Categorisation in **A, B, C, best value: C**

The dosing level quality feature

comes from the values for reaction time, stabilisation time and behaviour during long-term weighing procedures. These parameters give information about how well-suited a model is for fine dosing, amongst other functions. In particular with these dosing procedures, the balance performs a balancing act between filtering out disruptive environmental influences, such as, for example, vibrations on the one hand, and the highest level of accuracy as well as rapid display when weighing goods right down to the smallest division [d] on the other hand. In addition this value is printed, whether drift effects influence the continuous measurement in long-term trials. Categorisation into **A, B, C, best value: C**

If you have further questions on the subject of “Which balance will be best for my application?”, then please ask your personal KERN product specialist who will be happy to help you.

Quick-Finder Precision balances

Readability [d] g	Weighing capacity [Max] g	Model KERN	Price excl. of VAT ex works €	Page	Quality code QUALITY	 For an explanation on the pictos, see front flap									
						1									
0,001	60	440-21A	350,-	33	AA					●		●		●	○
0,001	100	EMB 100-3	195,-	28	AA					●				●	○
0,001	100	PCB 100-3	265,-	32	AA					●		●		●	○
0,001	120	PFB 120-3	280,-	34	BA					●		●			
0,001	120	KB 120-3N	270,-	35	AA					●		●			○
0,001	200	EMB 200-3	210,-	28	AA					●				●	
0,001	200	EMB 200-3V	250,-	29	AA					●		●		●	
0,001	200	PFB 200-3	295,-	34	AA					●		●			
0,001	220	EW 220-3NM	620,-	40	AB					●		●	●		○
0,001	220	EG 220-3NM	760,-	40	BB		○	●				●	●		○
0,001	240	KB 240-3N	280,-	35	AA					●		●			○
0,001	240	572-30	530,-	37	BA					●		●			○
0,001	250	PCD 250-3	305,-	31	AA					●		●		●	○
0,001	250	PCB 250-3	290,-	32	AA					●		●		●	○
0,001	300	EMS 300-3	260,-	30	AA					●		●		●	
0,001	300	PFB 300-3	320,-	34	BA					●		●			
0,001	300	EWJ 300-3	450,-	36	BA			●				●	●		○
0,001	300	EWJ 300-3H	490,-	36	BA			●				●	●		○
0,001	300	572-31	540,-	37	BA					●		●			○
0,001	350	PCD 300-3	350,-	31	AA					●		●		●	○
0,001	350	PCB 350-3	300,-	32	AA					●		●		●	○
0,001	360	KB 360-3N	290,-	35	AA					●		●			○
0,001	420	572-32	550,-	37	BA					●		●			○
0,001	420	PLS 420-3F	590,-	38	BA					●		●			
0,001	420	PLJ 420-3F	700,-	38	BA			●				●	●		
0,001	420	EW 420-3NM	690,-	40	AB					●		●	●		○
0,001	420	EG 420-3NM	830,-	40	BB		○	●				●	●		○
0,001	620	PNS 600-3	620,-	39	BB					●		●			
0,001	620	PNJ 600-3M	730,-	39	BB		○	●				●	●		
0,001	620	EW 620-3NM	770,-	40	AB					●		●	●		○
0,001	620	EG 620-3NM	930,-	40	BB		○	●				●	●		○
0,001	620	PBS 620-3M	1370,-	41	BC					●		●	●		
0,001	620	PBJ 620-3M	1610,-	41	BC		○	●				●	●		
0,001	620	PES 620-3M	1280,-	42	BB					●		●	●		○
0,001	620	PEJ 620-3M	1480,-	42	BB		○	●				●	●		
0,001	720	PLS 720-3A	840,-	38	BC					●		●			
0,001	720	PLJ 720-3A	980,-	38	CC			●				●	●		
0,001	720	PLJ 720-3AM	990,-	38	CC		○	●				●	●		
0,001	1200	PLS 1200-3A	870,-	38	BC					●		●			
0,001	1200	PLJ 1200-3A	1000,-	38	CC			●				●	●		
0,001	2100	PLJ 2000-3A	1650,-	38	CC			●				●	●		
0,01	200	EMB 200-2	125,-	28	AA					●				●	
0,01	200	PCB 200-2	230,-	32	AA					●		●		●	○
0,01	200	440-33N	290,-	33	AA					●		●		●	○
0,01	400	440-35N	330,-	33	AA					●		●		●	○
0,01	600	EMB 600-2	160,-	28	AA					●				●	
0,01	600	440-35A	365,-	33	AA					●		●		●	○
0,01	600	PFB 600-2	240,-	34	BA					●		●			
0,01	600	EWJ 600-2SM	350,-	36	BA		○	●				●	●		○
0,01	600	EWJ 600-2M	360,-	36	BA		○	●				●	●		○
0,01	650	KB 650-2N	250,-	35	BA					●		●			○
0,01	650	573-34	500,-	37	BA					●		●			○
0,01	820	EW 820-2NM	540,-	40	BB					●		●	●		○
0,01	1000	EMB 1000-2	195,-	28	AA					●				●	
0,01	1000	PCB 1000-2	255,-	32	AA					●		●		●	○
0,01	1200	PFB 1200-2	245,-	34	AA					●		●			
0,01	1200	KB 1200-2N	260,-	35	BA					●		●			○
0,01	1600	572-33	500,-	37	BA					●		●			○
0,01	2000	EMB 2000-2	205,-	28	AA					●				●	
0,01	2000	EMB 2000-2V	250,-	29	AA					●		●		●	
0,01	2000	PFB 2000-2	260,-	34	BA					●		●			
0,01	2000	KB 2000-2N	260,-	35	BA					●		●			○
0,01	2200	EW 2200-2NM	660,-	40	BB					●		●	●		○
0,01	2200	EG 2200-2NM	820,-	40	BB		○	●				●	●		○
0,01	2200	PES 2200-2M	840,-	42	BB					●		●	●		○
0,01	2200	PEJ 2200-2M	1060,-	42	CB		○	●				●	●		
0,01	2400	KB 2400-2N	270,-	35	BA					●		●			○
0,01	2400	572-35	510,-	37	BA					●		●			○
0,01	2500	PCD 2500-2	295,-	31	BA					●		●		●	○
0,01	2500	PCB 2500-2	290,-	32	BA					●		●		●	○
0,01	3000	EMS 3000-2	240,-	30	BA					●		●		●	○

Quick-Finder Precision balances

Readability [d] g	Weighing capacity [Max] g	Model KERN	Price excl. of VAT ex works €	Page	Quality code QUALITY															
						For an explanation on the pictos, see front flap														
0,01	3000	PFB 3000-2	280,-	34	AA	1														
0,01	3000	EWJ 3000-2	430,-	36	BA	1														
0,01	3000	572-37	520,-	37	BA	1														
0,01	3100	PLJ 3000-2FM	390,-	38	BA	1														
0,01	3200	PNS 3000-2	580,-	39	BB	1														
0,01	3200	PNJ 3000-2M	705,-	39	BB	1														
0,01	3500	PCD 3000-2	350,-	31	BA	1														
0,01	3500	PCB 3500-2	300,-	32	AA	1														
0,01	3600	KB 3600-2N	290,-	35	BA	1														
0,01	4200	572-39	530,-	37	BA	1														
0,01	4200	PLS 4200-2F	590,-	38	BA	1														
0,01	4200	PLJ 4200-2F	690,-	38	BA	1														
0,01	4200	EW 4200-2NM	760,-	40	BB	1														
0,01	4200	EG 4200-2NM	880,-	40	BB	1														
0,01	4200	PBS 4200-2M	1160,-	41	BC	1														
0,01	4200	PBJ 4200-2M	1430,-	41	CC	1														
0,01	4200	PES 4200-2M	1000,-	42	BB	1														
0,01	4200	PEJ 4200-2M	1230,-	42	CB	1														
0,01	6200	PLS 6200-2A	870,-	38	BC	1														
0,01	6200	PLJ 6200-2A	990,-	38	CC	1														
0,01	6200	PLJ 6200-2AM	1000,-	38	CC	1														
0,01	6200	EW 6200-2NM	810,-	40	BB	1														
0,01	6200	PBS 6200-2M	1390,-	41	BC	1														
0,01	6200	PBJ 6200-2M	1730,-	41	CC	1														
0,01	6200	PES 6200-2M	1240,-	42	BB	1														
0,01	8200	PLS 8000-2A	1050,-	38	BC	1														
0,05	6000	PFB 6000-2	250,-	34	BA	1														
0,05	10000	KB 10K0.05N	260,-	35	BA	1														
0,05	12000	572-45	510,-	37	BA	1														
0,05	20000	572-55	540,-	37	BA	1														
0,1	200	EMB 200-1SS05	180,-*	27	AA	1														
0,1	400	440-43N	185,-	33	AA	1														
0,1	500	EMB 500-1SS05	200,-*	27	AA	1														
0,1	500	EMB 500-1	55,-	28	AA	1														
0,1	500	EMB 500-1BE	55,-	28	AA	1														
0,1	1000	PCB 1000-1	185,-	32	AA	1														
0,1	1000	440-45N	245,-	33	AA	1														
0,1	1200	EMB 1200-1	78,-	28	AA	1														
0,1	2000	PCB 2000-1	215,-	32	AA	1														
0,1	2000	440-47N	270,-	33	AA	1														
0,1	3000	EMB 3000-1S	105,-	27	AA	1														
0,1	3000	EMB 3000-1	125,-	28	AA	1														
0,1	4000	440-49N	330,-	33	AA	1														
0,1	6000	EMB 6000-1	160,-	28	AA	1														
0,1	6000	EMS 6K0.1	160,-	30	AA	1														
0,1	6000	PCD 6K-4	260,-	31	BA	1														
0,1	6000	PCB 6000-1	240,-	32	BA	1														
0,1	6000	440-49A	365,-	33	AA	1														
0,1	6000	PFB 6000-1	225,-	34	BA	1														
0,1	6000	EWJ 6000-1SM	340,-	36	BA	1														
0,1	6000	EWJ 6000-1M	350,-	36	BA	1														
0,1	6500	KB 6500-1N	240,-	35	BA	1														
0,1	6500	573-46	500,-	37	BA	1														
0,1	8200	PBJ 8200-1M	1420,-	41	CC	1														
0,1	10000	PCD 10K0.1	240,-	31	BA	1														
0,1	10000	PCB 10000-1	245,-	32	BA	1														
0,1	10000	KB 10000-1N	250,-	35	BA	1														
0,1	10000	572-43	500,-	37	BA	1														
0,1	12000	EMS 12K0.1	205,-	30	BA	1														
0,1	12000	PNS 12000-1	570,-	39	BB	1														
0,1	12000	PNJ 12000-1M	705,-	39	BB	1														
0,1	12000	EW 12000-1NM	630,-	40	BB	1														
0,1	15000	PES 15000-1M	1190,-	42	BB	1														
0,1	16000	572-49	510,-	37	BA	1														
0,1	20000	PLS 20000-1F	570,-	38	BA	1														
0,1	24000	572-57	510,-	37	BA	1														
0,1	31000	PES 31000-1M	2050,-	42	CB	1														
1	2000	EMB 2000-0SS05	180,-*	27	AA	1														
1	2200	EMB 2200-0	57,-	28	AA	1														
1	4000	440-51N	160,-	33	AA	1														
1	5000	EMB 5000-0SS05	200,-*	27	AA	1														

Quick-Finder Precision balances

Readability [d] g	Weighing capacity [Max] g	Model KERN	Price excl. of VAT ex works €	Page	Quality code QUALITY	DAYS	M	CAL INT	CAL EXT	MEMORY	RS 232	PCS	TOL	BATT	ACCU	For an explanation on the pictos, see front flap	
1	5200	EMB 5.2K1	60,-	28	AA	1			●						●		
1	6000	EMS 6K1	70,-	30	AA	1			●			●			●		
1	6000	PCB 6000-0	130,-	32	BA	1			●		●	●			●	○	
1	6000	440-53N	180,-	33	AA	1			●		●	●			●	○	
1	10000	PCD 10K-3	190,-	31	BA	1			●		●	●			●	○	
1	12000	EMS 12K1	65,-	30	AA	1			●			●			●		
5	5200	EMB 5.2K5	55,-	28	AA	1			●			●			●		

News 2019

● = standard ○ = option

www.kern-sohn.com



Straight to the target!

Get straight to the right product. Use our new topic area search.
Here you will quickly find products which suit your particular
area of expertise.



Models with addition -S05



The space miracle – stackable school balance for experiment-based teaching

Features

- **Simple and convenient 2-key operation**
- **Tare function** facilitates formulation work
- **Particularly flat design**
- **Secure and non-slip positioning** with rubber feet
- **1** Stackable for space-saving storage
- **2** A practical **transport safety lock** prevents the weighing technology from being overloaded when stacked, stored or during transportation

Technical data

- Large LCD display, digit height 15 mm
- Dimensions weighing surface, plastic, \varnothing 120 mm
- Overall dimensions WxDxH 145x205x45 mm
- Optional battery operation, 2x 1.5 V AA, standard, operating time up to 35 h, AUTO-OFF function to preserve the battery
- Net weight approx. 0,50 kg
- Permissible ambient temperature 5 °C/35 °C
- **Note:** Models with addition -S05 are supplied in 5 pieces. This means that the price given in the table refers to a delivery of 5 items. Cannot be delivered individually. The calibration prices given here refer to calibration of a single balance

Accessories

- **External universal mains adapter**, with universal input and optional input socket adapters for EU, GB, USA, KERN YKA-03, **€ 31,-**

STANDARD

CAL EXT UNIT BATT DMS 1 DAY

OPTION

B MULTI DAKkS +3 DAYS

Model	Weighing capacity [Max] g	Readability [d] g	Reproducibility g	Linearity g	Quantity delivered	Price excl. of VAT ex works €	Option		Quantity delivered
							DAkkS KERN	DAkkS Calibr. Certificate €	
KERN EMB 200-1SS05	200	0,1	0,2	± 0,3	5	180,-	963-127	72,-	1
EMB 500-1SS05	500	0,1	0,2	± 0,3	5	200,-	963-127	72,-	1
EMB 3000-1S <small>NEW</small>	3000	0,1	0,2	± 0,3	1	105,-	963-127	72,-	1
EMB 2000-OSS05	2000	1	2	± 3	5	180,-	963-127	72,-	1
EMB 5000-OSS05	5000	1	2	± 3	5	200,-	963-127	72,-	1

NEW New model



Entry level laboratory balance with tremendous weighing performance

Features

- **Simple and convenient 2-key operation**
- **Tare function** facilitates formulation work
- **Particularly flat design**
- **Ready for use:** Batteries included
- **1 Ring-shaped draught shield** standard, only for models with weighing plate size **A**, weighing space $\varnothing \times H$ 96×35 mm
- **Hook for underfloor weighing** standard
- **2** Note: KERN EMB 500-1BE Black Edition

Technical data

- Large LCD display, digit height 15 mm
- Dimensions weighing surface, plastic, with conductive lacquer
 - A** \varnothing 82 mm
 - B** \varnothing 105 mm
 - C** \varnothing 150 mm, see larger picture
- Weighing plate material
 - A** plastic, with conductive lacquer
 - B, C** plastic
- Net weight approx. 0,75 kg
- Permissible ambient temperature 5 °C/35 °C

Accessories

- **3 Stainless steel weighing plate**, only for models with weighing plate size **B**, KERN EMB-A02, **€ 26,-**
- **4 Stack frame** for space-saving storage of precision balances from the KERN EMB range, scope of delivery 5 pieces, for models with housing dimensions W×D×H 170×244×39 mm, KERN EMB-A07, **€ 70,-** 170×244×52 mm, KERN EMB-A09, **€ 85,-**
- **External universal mains adapter**, with universal input and optional input socket adapters for EU, GB, USA, KERN YKA-03, **€ 31,-**

STANDARD

CAL EXT UNIT UNDER BATT DMS 1 DAY

OPTION

B MULTI DAKKS +3 DAYS

Model	Weighing capacity [Max] g	Readability [d] g	Reproducibility g	Linearity g	Weighing plate	Price excl. of VAT ex works €	Option DAkkS Calibr. Certificate	
							DAKKS KERN	€
KERN								
EMB 100-3	100	0,001	0,001	± 0,005	A	195,-	963-127	72,-
EMB 200-3	200	0,001	0,001	± 0,005	A	210,-	963-127	72,-
EMB 200-2	200	0,01	0,01	± 0,02	B	125,-	963-127	72,-
EMB 600-2	600	0,01	0,01	± 0,03	B	160,-	963-127	72,-
EMB 1000-2	1000	0,01	0,01	± 0,05	C	195,-	963-127	72,-
EMB 2000-2	2000	0,01	0,01	± 0,05	C	205,-	963-127	72,-
EMB 500-1	500	0,1	0,1	± 0,2	C	55,-	963-127	72,-
EMB 500-1BE	500	0,1	0,1	± 0,2	C	55,-	963-127	72,-
EMB 1200-1	1200	0,1	0,1	± 0,3	C	78,-	963-127	72,-
EMB 3000-1	3000	0,1	0,1	± 0,3	C	125,-	963-127	72,-
EMB 6000-1	6000	0,1	0,1	± 0,3	C	160,-	963-128	88,-
EMB 2200-0	2200	1	1	± 2	C	57,-	963-127	72,-
EMB 5.2K1	5200	1	1	± 3	C	60,-	963-128	88,-
EMB 5.2K5	5200	5	5	± 10	C	55,-	963-128	88,-

Price reduction



04

School balance with integrated density determination function

Features

- **Density determination made easy!** Thanks to the self-explanatory, graphic-assisted control panel, the density of solids and liquids can be determined in seconds, making them ideal for use in schools and universities
- **Self-explanatory graphic control panel**, the workings steps can be understood immediately, even without operating instructions
 - no learning time = reduces costs
 - ideal for untrained users
 - visualised process avoids operating errors
- **The 4 steps are carried out from left to right:**
 - 1 Tare the balance by pressing the [TARE] key
 - 2 Select density determination mode (solids/liquids)
 - 3 Weighing of samples/plummetts in air
 - 4 Weighing of samples/plummetts in liquid. The density will be shown on the display right away
- **Particularly flat design**
- **Hook for underfloor weighing** standard
- **Ready for use:** Batteries included, 9 V block, operating time up to 12 h, AUTO-OFF function to preserve the battery

• **Note: Balance and appropriate set for density determination should be ordered at the same time, see accessories**

Technical data

- Large LCD display, digit height 15 mm
- Dimensions weighing surface, plastic
 - A Ø 82 mm
 - B Ø 150 mm, see larger picture
- Overall dimensions W×D×H 175×245×54 mm
- Net weight approx. 0,85 kg
- Permissible ambient temperature 5 °C/35 °C
- **Now also with carat weighing unit:**
 - EMB 200-3V: 1000 ct/0,005 ct
 - EMB 2000-2V: 10000 ct/0,05 ct

Accessories

KERN EMB 200-3V:

- **5 Set for density determination** of liquids and solids with density $\leq/\geq 1$. Scope of delivery: Weighing plate, beaker (H×Ø 71×51 mm), sample holder, plummet, KERN YDB-01, **€ 215,-**
- **DAKKS-Calibration certificate** for the plummet (20 g), KERN 962-335V, **€ 143,-**

KERN EMB 2000-2V:

- **6 Set for density determination** of liquids and solids with density $\leq/\geq 1$. Scope of delivery: Weighing plate, beaker (H×Ø 135×100 mm), sample holder, plummet, KERN YDB-02, **€ 330,-**
- **DAKKS-Calibration certificate** for the plummet (200 g), KERN 962-338V, **€ 141,-**

STANDARD



OPTION



Model	Weighing capacity [Max] g	Readability [d] g	Reproducibility g	Linearity g	Weighing plate	Price excl. of VAT ex works €	Option	
							DAKKS KERN	DAKKS Calibr. Certificate €
EMB 200-3V	200	0,001	0,002	± 0,005	A	250,-	963-127	72,-
EMB 2000-2V	2000	0,01	0,02	± 0,05	B	250,-	963-127	72,-



04



Entry level model in the low-cost range with large weighing plate

Features

- Especially suitable for use in schools and universities, for example for biology, chemistry, physics
- **Large, shock proof weighing plate made of plastic, with conductive lacquer**
- **Particularly flat design**
- **Ergonomically optimised key pad** with large keys and a high-contrast LCD display
- **Secure and non-slip positioning** with rubber feet
- **Adjusting program CAL** for quick setting of the balance accuracy, external test weights at an additional price, see *Test weights*
- **1 Draught shield** standard for models with weighing plate size **A**, weighing space W×D×H 145×145×65 mm

Technical data

- LCD display, digit height 25 mm
- Dimensions weighing surface
 - A** ø 105 mm
 - B** W×D 175×190 mm, see larger picture
- Weighing plate material
 - A** plastic, with conductive lacquer
 - B** plastic
- Overall dimensions W×D×H 200×280×63 mm (without draught shield)
- Optional battery operation, 9 V block not included, operating time up to 40 h
- External mains adapter standard
- Net weight approx. 1,4 kg
- Permissible ambient temperature 5 °C/35 °C

Accessories

- **2 Stainless steel weighing plate**, only for models with weighing plate size **B**, KERN EMS-A01, € 30,-

STANDARD



OPTION



Model	Weighing capacity [Max] g	Readability [d] g	Reproducibility g	Linearity g	Weighing plate	Quality code	Price excl. of VAT ex works €	Option	
								DAKKS KERN	€
KERN EMS 300-3	300	0,001	0,002	± 0,005	A	AA	260,-	963-127	72,-
EMS 3000-2	3000	0,01	0,02	± 0,05	B	BA	240,-	963-127	72,-
EMS 6K0.1	6000	0,1	0,1	± 0,3	B	AA	160,-	963-128	88,-
EMS 12K0.1	12000	0,1	0,1	± 0,3	B	BA	205,-	963-128	88,-
EMS 6K1	6000	1	1	± 3	B	AA	70,-	963-128	88,-
EMS 12K1	12000	1	1	± 3	B	AA	65,-	963-128	88,-

Price reduction



High-resolution precision balance with removable display for maximum flexibility

Features

- Laboratory balance with separate platform: Ideal when working in the glove bag or fume cupboard. Particularly practical for weighing toxic, volatile or contaminated substances
- **PRE-TARE function** for manual subtraction of a known container weight, useful for checking fill-levels
- **Freely programmable weighing unit**, e.g. display direct in special units such as length of thread g/m, paper weight g/m², or similar
- **Level indicator and levelling feet** for precise levelling of the scale, fitted as standard, to give the most accurate weighing result
- **1 Draught shield** standard for models with weighing plate size **A**, weighing space W×D×H 146×146×80 mm
- **Protective working cover** included with delivery

Technical data

- Large backlit LCD display, digit height 21 mm
- Dimensions weighing surface
 - A** Ø 105 mm
 - B** W×D 160×160 mm, see larger picture
- Weighing plate material
 - A** plastic, with conductive lacquer
 - B** stainless steel
- Dimensions of display device W×D×H 140×46×75 mm
- Optional battery operation, 9 V block not included, operating time up to 12 h, AUTO-OFF function to preserve the battery
- Overall dimensions W×D×H 165×280×75 mm
- Cable length of display device approx. 1,2 m
- Net weight approx. 1,2 kg
- Permissible ambient temperature 5 °C/35 °C

Accessories

- **Protective working cover** over the display device, scope of delivery: 5 items, KERN PCD-A05S05, **€ 40,-**
- **2 Stand** to elevate display device, height of stand approx. 250 mm, KERN PCD-A03, **€ 50,-**
- **Rechargeable battery pack internal**, operating time up to 24 h without backlight, charging time approx. 10 h, KERN PCD-A04, **€ 50,-**
- **3 Foot switch**, ideal when the application requires two free hands. TARE or PRINT function can be selected. Scope of delivery: foot switch, junction box, connection cable. For the PRINT function you will need the RS-232 interface cable, KERN YKF-01, **€ 85,-**
- **RS-232/Ethernet adapter** for connection to an IP-based Ethernet network, KERN YKI-01, **€ 290,-**
- **Individual header data:** the free software can be used to print 4 header lines on the printout when using printers 911-013, YKN-01, YKB-01N, YKE-01 and YKC-01 (in combination with YKI-02)
- Further details, plenty of further accessories and suitable printers see *Accessories*

STANDARD

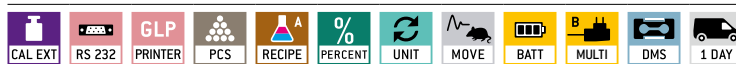

OPTION



Model	Weighing capacity [Max] g	Readability [d] g	Reproducibility g	Linearity g	Weighing plate	Quality code	Price excl. of VAT ex works €	Option	
								DAKKS KERN	DAKKS Calibr. Certificate €
KERN PCD 250-3	250	0,001	0,002	± 0,005	A	AA	305,-	963-127	72,-
KERN PCD 300-3	350	0,001	0,002	± 0,005	A	AA	350,-	963-127	72,-
KERN PCD 2500-2	2500	0,01	0,02	± 0,05	B	BA	295,-	963-127	72,-
KERN PCD 3000-2	3500	0,01	0,02	± 0,05	B	BA	350,-	963-127	72,-
KERN PCD 6K-4	6000	0,1	0,1	± 0,3	B	BA	260,-	963-128	88,-
KERN PCD 10K0.1	10000	0,1	0,1	± 0,3	B	BA	240,-	963-128	88,-
KERN PCD 10K-3	10000	1	1	± 3	B	BA	190,-	963-128	88,-



The standard in the laboratory

Features

- **PRE-TARE function** for manual subtraction of a known container weight, useful for checking fill-levels
- **Freely programmable weighing unit**, e.g. display direct in special units such as length of thread g/m, paper weight g/m², or similar
- With the **recipe function** you can weigh the different ingredients of a mixture. As a check, you can also call up the total weight of all the ingredients
- **Plus/minus weighing procedures**
- **Ring-shaped draught shield** standard, only for models with weighing plate size **A**, weighing space $\varnothing \times H$ 90×40 mm
- **Protective working cover** included with delivery

Technical data

- Backlit LCD display, digit height 15 mm
- Dimensions weighing surface
 - A** \varnothing 81 mm
 - B** \varnothing 105 mm
 - C** W×D 130×130 mm
 - D** W×D 150×170 mm, see larger picture
- Weighing plate material
 - A** plastic, with conductive lacquer
 - B, C, D** stainless steel
- Overall dimensions W×D×H 163×245×79 mm (without draught shield)
- Optional battery operation, 9 V block not included, operating time up to 20 h, AUTO-OFF function to preserve the battery
- Permissible ambient temperature 5 °C/35 °C

Accessories

- **Protective working cover**, scope of delivery: 5 items, for models with weighing plate size
 - A** KERN PCB-A02S05, € 40,-
 - B** KERN PCB-A03S05, € 40,-
 - C** KERN PCB-A04S05, € 40,-
 - D** KERN PCB-A05S05, € 40,-
- **Rechargeable battery pack internal**, operating time up to 48 h without backlight, charging time approx. 8 h, KERN PCB-A01, € 75,-
- **RS-232/Ethernet adapter** for connection to an IP-based Ethernet network, KERN YKI-01, € 290,-
- **Balance Connection Software**, KERN SCD-4.0, € 150,-
- **Individual header data**: the free software SHM-01 can be used to print 4 header lines on the printout when using printers 911-013, YKN-01, YKB-01N, YKE-01 and YKC-01 (in combination with YKI-02)
- Further details, plenty of further accessories and suitable printers see *Accessories*

STANDARD



OPTION



Model	Weighing capacity [Max] g	Readability [d] g	Reproducibility g	Linearity g	Weighing plate	Quality code	Price excl. of VAT ex works €	Option	
								DAKKS KERN	DAKKS Calibr. Certificate €
PCB 100-3	100	0,001	0,001	± 0,003	A	AA	265,-	963-127	72,-
PCB 250-3	250	0,001	0,001	± 0,005	A	AA	290,-	963-127	72,-
PCB 350-3	350	0,001	0,002	± 0,005	A	AA	300,-	963-127	72,-
PCB 200-2	200	0,01	0,01	± 0,02	B	AA	230,-	963-127	72,-
PCB 1000-2	1000	0,01	0,01	± 0,03	C	AA	255,-	963-127	72,-
PCB 2500-2	2500	0,01	0,01	± 0,05	C	BA	290,-	963-127	72,-
PCB 3500-2	3500	0,01	0,02	± 0,05	C	AA	300,-	963-127	72,-
PCB 1000-1	1000	0,1	0,1	± 0,2	C	AA	185,-	963-127	72,-
PCB 2000-1	2000	0,1	0,1	± 0,2	C	AA	215,-	963-127	72,-
PCB 6000-1	6000	0,1	0,1	± 0,3	D	BA	240,-	963-128	88,-
PCB 10000-1	10000	0,1	0,1	± 0,3	D	BA	245,-	963-128	88,-
PCB 6000-0	6000	1	1	± 2	D	BA	130,-	963-128	88,-



The classic balance in the laboratory

Features

- **Compact size**, practical for small spaces
- **Percentage determination:** makes it possible to store a given weight value (100 %) and to determine deviations from this target value
- **Ring-shaped draught shield** standard, only for models with weighing plate size **A**, weighing space $\varnothing \times H$ 90×40 mm
- **Protective working cover** included with delivery

Technical data

- Backlit LCD display, digit height 15 mm
- Dimensions weighing surface
 - A** \varnothing 81 mm
 - B** \varnothing 105 mm
 - C** W×D 130×130 mm
 - D** W×D 150×170 mm, see larger picture
- Weighing plate material
 - A** plastic, with conductive lacquer
 - B, C, D** stainless steel
- Overall dimensions (without draught shield) W×D×H 165×230×80 mm
- Optional battery operation, 9 V block not included, operating time up to 20 h, AUTO-OFF function to preserve the battery
- Net weight approx. 0,95 kg
- Permissible ambient temperature 5 °C/35 °C

Accessories

- **Protective working cover**, scope of delivery: 5 items, for models with weighing plate size
 - A** KERN 440-210-002S05, € 40,-
 - B** KERN 440-330-002S05, € 40,-
 - C** KERN 440-450-002S05, € 40,-
 - D** KERN 440-530-002S05, € 40,-
- **Internal rechargeable battery pack**, operating time up to 20 h without backlight, charging time approx. 10 h, KERN FCB-A01, € 50,-
- **Hook for underfloor weighing**, KERN 440-A01, € 25,-
- **RS-232/Ethernet adapter** for connection to an IP-based Ethernet network, KERN YKI-01, € 290,-
- **Individual header data:** the free software SHM-01 can be used to print 4 header lines on the printout when using printers 911-013, YKN-01, YKB-01N, YKE-01 and YKC-01 (in combination with YKI-02)
- Further details, plenty of further accessories and suitable printers see *Accessories*

STANDARD



OPTION



Model	Weighing capacity [Max] g	Readability [d] g	Reproducibility g	Linearity g	Weighing plate	Price excl. of VAT ex works €	Option	
							DAKKS KERN	DAKKS Calibr. Certificate €
440-21A	60	0,001	0,001	± 0,003	A	350,-	963-127	72,-
440-33N	200	0,01	0,01	± 0,02	B	290,-	963-127	72,-
440-35N	400	0,01	0,01	± 0,03	B	330,-	963-127	72,-
440-35A	600	0,01	0,01	± 0,03	B	365,-	963-127	72,-
440-43N	400	0,1	0,1	± 0,2	C	185,-	963-127	72,-
440-45N	1000	0,1	0,1	± 0,2	C	245,-	963-127	72,-
440-47N	2000	0,1	0,1	± 0,2	C	270,-	963-127	72,-
440-49N	4000	0,1	0,1	± 0,3	D	330,-	963-127	72,-
440-49A	6000	0,1	0,1	± 0,3	D	365,-	963-128	88,-
440-51N	4000	1	1	± 2	D	160,-	963-127	72,-
440-53N	6000	1	1	± 2	D	180,-	963-128	88,-

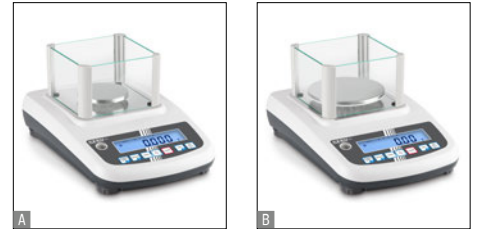

Quick-display precision balance with user-friendly concept of operation modes – now with larger housing for more stability

Features

- **Easy to use:** All primary functions have their own key on the keypad
- **Compact size,** practical for small spaces
- **Capacity display:** A bar lights up to show how much of the weighing capacity is still available
- **Level indicator and levelling feet** for precise levelling of the scale, fitted as standard, to give the most accurate weighing result
- **Draught shield** standard for models with weighing plate size **A** and **B**, Weighing space W×D×H 158×143×64 mm

Technical data

- Backlit LCD display, digit height 15 mm
- Dimensions weighing surface, stainless steel
 - A** Ø 80 mm
 - B** Ø 120 mm
 - C** W×D 155×145 mm, see larger picture
- Overall dimensions W×D×H 210×315×90 mm (without draught shield)
- Net weight approx. 2,0 kg
- Permissible ambient temperature 15 °C/30 °C

Accessories

- **Protective working cover,** scope of delivery: 5 items, KERN PFB-A12S05, **€ 40,-**
- **Separate second display,** ideal for training and demonstration purposes in laboratories or industry, not permitted for direct sales to the public, KERN PFB-A08, **€ 115,-**
- **Bluetooth data interface** for wireless data transfer to PC or tablets, must be ordered at purchase
 - Bluetooth 2.0: KERN PFB-A10, **€ 95,-**
 - Bluetooth 4.0: KERN PFB-A11, **€ 125,-**
- Further details, plenty of further accessories and suitable printers see *Accessories*

STANDARD



OPTION



FACTORY

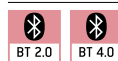

Model	Weighing capacity [Max] g	Readability [d] g	Reproducibility g	Linearity g	Weighing plate	Price excl. of VAT ex works €	Option	
							DAKKS KERN	DAKKS Calibr. Certificate €
PFB 120-3	120	0,001	0,001	± 0,003	A	280,-	963-127	72,-
PFB 200-3	200	0,001	0,002	± 0,005	A	295,-	963-127	72,-
PFB 300-3	300	0,001	0,002	± 0,005	A	320,-	963-127	72,-
PFB 600-2	600	0,01	0,01	± 0,03	B	240,-	963-127	72,-
PFB 1200-2	1200	0,01	0,01	± 0,03	B	245,-	963-127	72,-
PFB 2000-2	2000	0,01	0,02	± 0,05	B	260,-	963-127	72,-
PFB 3000-2	3000	0,01	0,02	± 0,05	B	280,-	963-127	72,-
PFB 6000-1	6000	0,1	0,1	± 0,3	C	225,-	963-128	88,-
PFB 6000-2	6000	0,05	0,05	± 0,15	C	250,-	963-128	88,-



Compact precision balance with large weighing capacity

Features

- Thanks to the **many typical laboratory functions**, such as, for example, recipe function, percentage determination, GLP record keeping, combined with the high level of precision, the KERN KB-N is a reliable partner for day-to-day work in the laboratory
- **User guidance step by step** on display by Yes/No dialogue
- **Freely programmable weighing unit**, e.g. display direct in special units such as length of thread g/m, paper weight g/m², or similar
- **Ring-shaped draught shield** standard, only for models with weighing plate size **A**, weighing space $\varnothing \times H$ 90×40 mm
- Model with resolution $\geq 240,000$ Pt.: **Level indicator to level the balance precisely**
- **Protective working cover** included with delivery

Technical data

- Backlit LCD display, digit height 9 mm
- Dimensions weighing surface
 - A** \varnothing 81 mm, plastic, with conductive lacquer
 - B** W×D 130×130 mm, stainless steel
 - C** W×D 150×170 mm, stainless steel, see larger picture
- Overall dimensions W×D×H 167×250×85 mm (without draught shield)
- Net weight approx. 1,00 kg
- Permissible ambient temperature 10 °C/40 °C

Accessories

- **Protective working cover**, scope of delivery: 5 items, for models with weighing plate size
 - A** KERN PCB-A02S05, € 40,-
 - B** KERN PCB-A04S05, € 40,-
 - C** KERN PCB-A05S05, € 40,-
- **Rechargeable battery pack internal**, operating time up to 30 h without backlight, charging time approx. 10 h, KERN KB-A01N, € 50,-
- **Rechargeable battery pack external**, operating time up to 30 h without backlight, charging time approx. 10 h, KERN KS-A01, € 160,-
- Further details, plenty of further accessories and suitable printers see *Accessories*

STANDARD

CAL EXT RS 232 GLP PRINTER PCS RECIPE PERCENT UNIT MOVE UNDER MULTI DMS 1 DAY

OPTION

ACCU DAKKS +3 DAYS

Model	Weighing capacity [Max] g	Readability [d] g	Reproducibility g	Linearity g	Weighing plate	Quality code	Price excl. of VAT ex works €	Option	
								DAkkS KERN	€
KERN KB 120-3N	120	0,001	0,001	± 0,003	A	AA	270,-	963-127	72,-
KERN KB 240-3N	240	0,001	0,001	± 0,003	A	AA	280,-	963-127	72,-
KERN KB 360-3N	360	0,001	0,002	± 0,005	A	AA	290,-	963-127	72,-
KERN KB 650-2N	650	0,01	0,01	± 0,03	B	BA	250,-	963-127	72,-
KERN KB 1200-2N	1200	0,01	0,01	± 0,03	B	BA	260,-	963-127	72,-
KERN KB 2000-2N	2000	0,01	0,01	± 0,03	B	BA	260,-	963-127	72,-
KERN KB 2400-2N	2400	0,01	0,01	± 0,03	B	BA	270,-	963-127	72,-
KERN KB 3600-2N	3600	0,01	0,02	± 0,05	B	BA	290,-	963-127	72,-
KERN KB 10K0.05N	10000	0,05	0,05	± 0,15	C	BA	260,-	963-128	88,-
KERN KB 6500-1N	6500	0,1	0,1	± 0,3	C	BA	240,-	963-128	88,-
KERN KB 10000-1N	10000	0,1	0,1	± 0,3	C	BA	250,-	963-128	88,-

↓ Price reduction

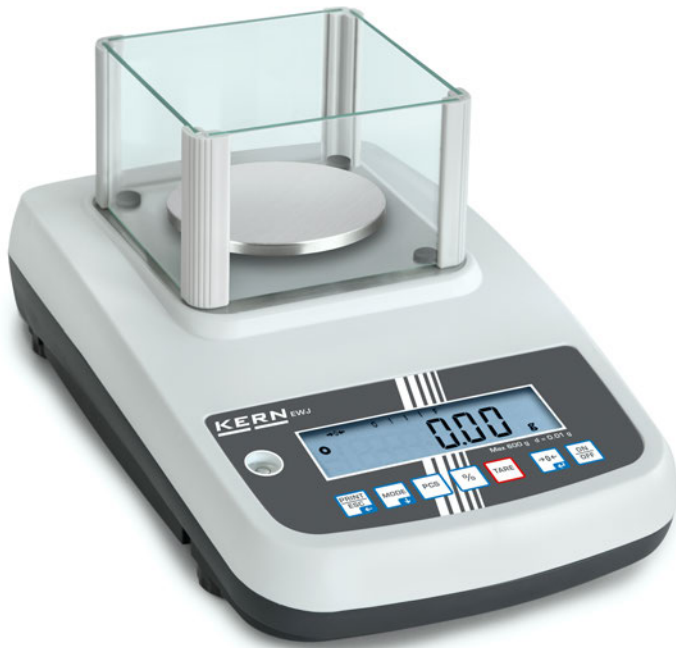
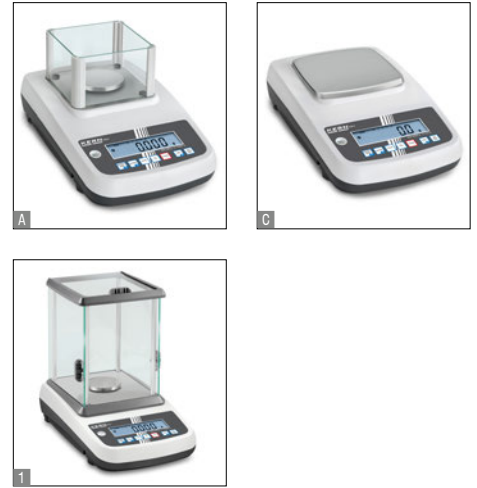

High-quality precision balance with automatic internal adjustment, also with EC type approval [M]

Features

- **Easy to use:** All primary functions have their own key on the keypad
- **Automatic internal adjustment,** time-controlled every 2 h, guarantees high degree of accuracy and makes the balance independent of its location
- **Capacity display:** A bar lights up to show how much of the weighing capacity is still available
- KERN EWJ/EWJ-H/EWJ-M: **USB interface** for transferring weighing data to the PC, printer etc., possibly in conjunction with KERN DBS-A02
- **Draft shield** standard on models KERN EWJ 300-3, EWJ 600-2SM, EWJ 600-2M, weighing space W×D×H 160×145×80 mm
- **KERN EWJ 300-3H: Large glass draught shield** with 3 sliding doors for easy access to the items being weighed. Weighing space W×D×H 175×155×217 mm

- **Protective working cover** included with delivery

Technical data

- Large backlit LCD display, digit height 16,5 mm
- Dimensions weighing surface
 - A** Ø 80 mm
 - B** Ø 120 mm, see larger picture
 - C** W×D 155×145 mm
- Overall dimensions W×D×H
 - 220×315×90 mm (without draught shield)
 - 220×340×321 mm (incl. draught shield)
- Permissible ambient temperature
 - KERN EWJ: 15 °C/35 °C
 - KERN EWJ-M: 15 °C/30 °C

Accessories

- **Protective working cover,** scope of delivery: 5 items, KERN EWJ-A04S05, **€ 40,-**
- **Rechargeable battery pack internal,** operating time up to 15 h without backlight, charging time approx. 4 h, KERN KFB-A01, **€ 35,-**
- KERN EWJ/-EWJ-H/EWJ-M: **USB Accessory Kit** for bi-directional data exchange between balance/moisture analyser and computer. Scope of delivery: USB cable, driver, Software BalanceConnection, KERN DBS-A02, **€ 290,-**
- **RS-232/WiFi adapter** for wireless connection to networks and WiFi capable devices, such as tablets, laptops or smartphones, KERN YKI-03, **€ 690,-**
- **RS-232/Ethernet adapter** for connection to an IP-based Ethernet network, KERN YKI-01, **€ 290,-**
- Further details, plenty of further accessories and suitable printers see *Accessories*

STANDARD										OPTION		FACTORY			
not EWJ-SM		not EWJ-SM												EWJ-M	

Model	Weighing capacity [Max] g	Readability [d] g	Verification value [e] g	Minimal load [Min] g	Linearity g	Weighing plate	Price excl. of VAT ex works €	Option			
								Verification		DAkKS Calibr. Certificate	
									€	DAkKS KERN	€
KERN EWJ 300-3	300	0,001	-	-	± 0,005	A	450,-	-	-	963-127	72,-
KERN EWJ 300-3H	300	0,001	-	-	± 0,005	A	490,-	-	-	963-127	72,-
KERN EWJ 3000-2	3000	0,01	-	-	± 0,05	B	430,-	-	-	963-127	72,-
Note: For applications that require verification, please order verification at the same time, initial verification at a later date is not possible. Verification at the factory, we need to know the full address of the location of use.											
KERN EWJ 600-2SM	600	0,01	0,1	0,5	± 0,03	B	350,-	965-216	66,-	963-127	72,-
KERN EWJ 600-2M	600	0,01	0,1	0,5	± 0,03	B	360,-	965-216	66,-	963-127	72,-
KERN EWJ 6000-1SM	6000	0,1	1	5	± 0,3	C	340,-	965-217	77,-	963-128	88,-
KERN EWJ 6000-1M	6000	0,1	1	5	± 0,3	C	350,-	965-217	77,-	963-128	88,-



All-rounder e.g. as precision balance in the laboratory or in harsh industrial applications

Features

- Thanks to the **many typical laboratory functions**, such as, for example, recipe function, percentage determination, GLP record keeping, combined with the high level of precision, the KERN 572 · 573 is a reliable partner for day-to-day work in the laboratory
- **The robust version**, typical industrial functions, such as piece-counting, vibrationfree weighing and the large weighing capacities also make these balances ideal for all industrial applications, where a high level of precision is required
- **Freely programmable weighing unit**, e.g. display direct in special units such as length of thread g/m, paper weight g/m², or similar

- **The robust aluminium diecast housing** maintains the stability, protects the weighing technology elements and is robust enough to cope with everyday use
- **Ring-shaped draught shield** standard, only for models with weighing plate size **A**, weighing space $\varnothing \times H$ 157×43 mm
- Model with resolution $\geq 240,000$ Pt.: **level indicator to level the balance precisely** as standard
- **Loop and hook for underfloor weighing**, standard for models with [d] = 0,001 g
- **Protective working cover** included with delivery

Technical data

- Large backlit LCD display, digit height 18 mm
- Dimensions weighing surface, stainless steel
 - A** \varnothing 106 mm
 - B** \varnothing 150 mm
 - C** W×D 160×200 mm, see larger picture
- Overall dimensions W×D×H 180×310×85 mm
- Permissible ambient temperature 10 °C/40 °C

Accessories

- **Protective working cover**, scope of delivery: 5 items, KERN 572-A02S05, **€ 40,-**
- **Rechargeable battery pack external**, operating time up to 30 h without backlight, charging time approx. 10 h, KERN KS-A01, **€ 160,-**
- **Loop and hook for underfloor weighing**, for models with [d] $\geq 0,01$ g, KERN 572-A03, **€ 25,-**
- **Large glass draught shield** with 3 sliding doors for easy access to the items being weighed. Weighing space W×D×H 150×140×130 mm, for models with weighing plate size **A**, KERN 572-A05, **€ 230,-**

STANDARD



OPTION

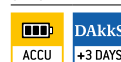

Model	Weighing capacity [Max] g	Readability [d] g	Reproducibility g	Linearity g	Resolution Points	Weighing plate	Price excl. of VAT ex works €	Option	
								DAKKS	DAKKS Calibr. Certificate
KERN 572-30	240	0,001	0,001	± 0,003	240.000	A	530,-	963-127	72,-
KERN 572-31	300	0,001	0,002	± 0,005	300.000	A	540,-	963-127	72,-
KERN 572-32	420	0,001	0,002	± 0,005	420.000	A	550,-	963-127	72,-
KERN 573-34	650	0,01	0,01	± 0,03	65.000	B	500,-	963-127	72,-
KERN 572-33	1600	0,01	0,01	± 0,03	160.000	B	500,-	963-127	72,-
KERN 572-35	2400	0,01	0,01	± 0,03	240.000	B	510,-	963-127	72,-
KERN 572-37	3000	0,01	0,02	± 0,05	300.000	B	520,-	963-127	72,-
KERN 572-39	4200	0,01	0,02	± 0,05	420.000	B	530,-	963-127	72,-
KERN 572-45	12000	0,05	0,05	± 0,15	240.000	C	510,-	963-128	88,-
KERN 572-55	20000	0,05	0,1	± 0,25	400.000	C	540,-	963-128	88,-
KERN 573-46	6500	0,1	0,1	± 0,3	65.000	C	500,-	963-128	88,-
KERN 572-43	10000	0,1	0,1	± 0,3	100.000	C	500,-	963-128	88,-
KERN 572-49	16000	0,1	0,1	± 0,3	160.000	C	510,-	963-128	88,-
KERN 572-57	24000	0,1	0,1	± 0,3	240.000	C	510,-	963-128	88,-



Technical data

- Backlit LCD display, digit height 17 mm
- Dimensions weighing surface, stainless steel
 - A Ø 80 mm
 - B Ø 110 mm
 - C Ø 160 mm, see larger picture
 - D WxD 200x175 mm
- 1 KERN PLS/PLJ-F: Strain gauge
- 2 KERN PLS/PLJ-A: Force compensation
- Permissible ambient temperature
 KERN PLS, PLJ: 5 °C/35 °C
 KERN PLJ-M: 15 °C/30 °C

Range of precision balances with enormous weighing capacities – ideal for heavy tare containers or large samples

Features

- A KERN PLJ 2000-3A: **High-quality milligram balance with enormous weighing capacity up to 2100 g** – ideal for large samples or heavy tare containers
- **Ergonomically optimised keypad** for left and righthanded users
- KERN PLJ: **Automatic internal adjustment**, guarantees high degree of accuracy and makes the balance independent of its location of use

- Ideal for mobile applications which require verification, such as ambulatory gold and jewellery purchasing
- KERN PLS: **Adjusting program CAL** for quick setting of the balance accuracy, external test weights at an additional price, see *Test weights*
- **Draught shield** standard for models with weighing plate size B, weighing space ØxH 60x150 mm
- **Protective working cover** included with delivery

Accessories

- **Protective working cover**, scope of delivery: 5 items, KERN PLJ-A01S05, **€ 40,-**
- 3 **Hook for underfloor weighing**, KERN PLJ-A02, **€ 30,-**
- **Set for density determination** of liquids and solids with density ≤/≥ 1 for models with [d] = 0,001 g, KERN ALT-A02, **€ 830,-** [d] = 0,01 g, KERN PLT-A01, **€ 830,-**
- **RS-232/Ethernet adapter** for connection to an IP-based Ethernet network, KERN YKI-01, **€ 290,-**
- Further details, plenty of further accessories and suitable printers see *Accessories*

STANDARD

CAL INT	CAL EXT	RS 232	GLP	PC	RECIPE	PERCENT	TOL	UNDER	MULTI	DMS	FORCE	1 DAY
PLJ	PLS							3	1	2		

OPTION

DAKKS
+3 DAYS

FACTORY

M
+3 DAYS
PLJ-M

Model	Weighing capacity [Max] g	Readability [d] g	Verification value [e] g	Minimal load [Min] g	Linearity g	Weighing plate	Quality code	Price excl. of VAT ex works €	Option			
									Verification		DAKKS Calibr. Certificate	
KERN								€	MO KERN	€	DAKKS KERN	€
PLS 420-3F	420	0,001	-	-	± 0,004	B	BA	590,-	-	-	963-127	72,-
PLS 720-3A	720	0,001	-	-	± 0,002	B	BC	840,-	-	-	963-127	72,-
PLS 1200-3A	1200	0,001	-	-	± 0,003	B	BC	870,-	-	-	963-127	72,-
PLS 4200-2F	4200	0,01	-	-	± 0,04	C	BA	590,-	-	-	963-127	72,-
PLS 6200-2A	6200	0,01	-	-	± 0,03	C	BC	870,-	-	-	963-128	88,-
PLS 8000-2A	8200	0,01	-	-	± 0,04	C	BC	1050,-	-	-	963-128	88,-
PLS 20000-1F	20000	0,1	-	-	± 0,4	D	BA	570,-	-	-	963-128	88,-
PLJ 420-3F	420	0,001	-	-	± 0,003	B	BA	700,-	-	-	963-127	72,-
PLJ 720-3A	720	0,001	-	-	± 0,002	B	CC	980,-	-	-	963-127	72,-
PLJ 1200-3A	1200	0,001	-	-	± 0,003	B	CC	1000,-	-	-	963-127	72,-
PLJ 2000-3A	2100	0,001	-	-	± 0,004	A	CC	1650,-	-	-	963-127	72,-
PLJ 3000-2FM*	3100	0,01	-	-	± 0,03	C	BA	390,-	-	-	963-127	72,-
PLJ 4200-2F	4200	0,01	-	-	± 0,04	C	BA	690,-	-	-	963-127	72,-
PLJ 6200-2A	6200	0,01	-	-	± 0,03	C	CC	990,-	-	-	963-128	88,-
Note: For applications that require verification, please order verification at the same time, initial verification at a later date is not possible. Verification at the factory, we need to know the full address of the location of use.												
PLJ 720-3AM	720	0,001	0,01	0,02	± 0,002	B	CC	990,-	965-216	66,-	963-127	72,-
PLJ 6200-2AM	6200	0,01	0,1	0,5	± 0,03	C	CC	1000,-	965-217	77,-	963-128	88,-

* ONLY WHILE STOCKS LAST!

Price reduction



The new standard in the laboratory with robust tuning fork weighing system

Features

- KERN PNJ: **Automatic internal adjustment**, guarantees high degree of accuracy and makes the balance independent of its location of use. Ideal for mobile applications which require verification, such as ambulatory gold and jewellery purchasing
- KERN PNS: **Adjusting program CAL** for quick setting of the balance accuracy using an external test weight
- **High-quality tuning fork measuring system** for steady weight values and continuous weighing
- **Capacity display:** A bar lights up to show how much of the weighing capacity is still available
- **Precise counting:** The automatic reference weight optimisation of reference weight gradually improves the average piece weight value
- **Compact size**, practical for small spaces
- **Large, shock proof weighing plate made of stainless steel**

- **Large glass draught shield** with 3 sliding doors for easy access to the items being weighed. Weighing space W×D×H 172×171×160 mm, for models with weighing plate size **A**
- **Protective working cover** included with delivery

Technical data

- Large LCD display, digit height 16,5 mm
- Dimensions weighing surface, stainless steel
 - A** Ø 140 mm
 - B** W×D 190×190 mm, see larger picture
- Overall dimensions W×D×H
 - A** 202×293×266 mm
 - B** 195×290×90 mm
- Net weight
 - A** approx. 2,2 kg
 - B** approx. 2,8 kg
- Permissible ambient temperature 5 °C/40 °C

Accessories

- **Protective working cover**, scope of delivery: 5 items, KERN PNJ-A01S05, **€ 40,-**
- **RS-232/Bluetooth adapter** to connect to Bluetooth capable devices, such as Bluetooth printers, tablets, laptops, smartphones, etc., KERN YKI-02, **€ 220,-**
- **RS-232/WiFi adapter** for wireless connection to networks and WiFi capable devices, such as tablets, laptops or smartphones, KERN YKI-03, **€ 690,-**
- **RS-232/Ethernet adapter** for connection to an IP-based Ethernet network, KERN YKI-01, **€ 290,-**
- **1 Precious stones plate**, aluminium with practical spout, W×D×H 83×66×23 mm, KERN AEJ-A05, **€ 40,-**
- Further details, plenty of further accessories and suitable printers see *Accessories*

STANDARD

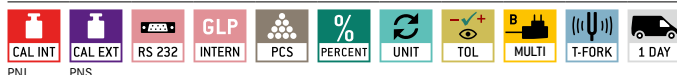

OPTION



FACTORY



Model	Weighing capacity [Max] g	Readability [d] g	Verification value [e] g	Minimal load [Min] g	Linearity g	Weighing plate	Price excl. of VAT ex works €	Option			
								Verification		DAkKS Calibr. Certificate	
KERN								M KERN	€	DAKKS KERN	€
PNS 600-3	620	0,001	-	-	± 0,004	A	620,-	-	-	963-127	72,-
PNS 3000-2	3200	0,01	-	-	± 0,02	B	580,-	-	-	963-127	72,-
PNS 12000-1	12000	0,1	-	-	± 0,2	B	570,-	-	-	963-128	88,-
Note: For applications that require verification, please order verificati on at the same time, initial verification at a later date is not possible. Verification at the factory, we need to know the full address of the location of use.											
PNJ 600-3M	620	0,001	0,01	0,02	± 0,004	A	730,-	965-216	66,-	963-127	72,-
PNJ 3000-2M	3200	0,01	0,1	0,5	± 0,02	B	705,-	965-216	66,-	963-127	72,-
PNJ 12000-1M	12000	0,1	1	5	± 0,2	B	705,-	965-217	77,-	963-128	88,-



The classic balance with robust tuning fork measuring system

Features

- **1** KERN EG-N: **Internal adjustment** in the case of a change in temperature and time-controlled at defined intervals, guarantees high degree of accuracy and makes the balance independent of its location of use
- KERN EW-N: **Adjusting program CAL** for quick setting of the balance accuracy using an external test weight
- **Stable temperature behaviour**
- **Short stabilisation time**
- **Shock proof construction**
- **High corner load performance**
- **Capacity display:** A bar lights up to show how much of the weighing capacity is still available
- **GLP/ISO record keeping** of weight values
- **Totalising** of pieces when counting

- **Draught shield** standard for models with weighing plate size **A**, weighing space W×D×H 158×130×78 mm
- **Protective working cover** included with delivery

Technical data

- Large LCD display, digit height 17 mm
- Dimensions weighing surface, stainless steel
 - A** Ø 118 mm, see larger picture
 - B** W×D 170×140 mm
 - C** W×D 180×160 mm
- Overall dimensions W×D×H, without draught shield
 - A, B** 182×235×75 mm
 - C** 192×275×87 mm
- Net weight approx. 1,4 kg
- Permissible ambient temperature 10 °C/30 °C

Accessories

- **Protective working cover**, scope of delivery: 5 items, for models with weighing plate size
 - A, B** KERN EG-A05S05, € 40,-
 - C** KERN EG-A09S05, € 40,-
- **Rechargeable battery pack internal**, operating time up to 32 h without backlight, charging time approx. 12 h, for models with weighing plate size
 - A, B** KERN EG-A04, € 110,-
 - C** KERN EG-A06, € 110,-
- **2 Large glass draught shield** with 3 sliding doors for easy access to the items being weighed. Weighing space W×D×H 150×140×130 mm, for models with weighing plate size **A**, KERN EG-A03, € 250,-
- **Loop for underfloor weighing**, for models with weighing plate size
 - A, B** KERN EG-A07, € 40,-
 - C** KERN EG-A08, € 40,-
- **Precious stones plate**, aluminium with practical spout, W×D×H 83×66×23 mm, KERN AEJ-A05, € 40,-
- Further details, plenty of further accessories and suitable printers see *Accessories*

STANDARD



OPTION

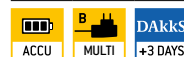

FACTORY



Model	Weighing capacity [Max] g	Readability [d] g	Verification value [e] g	Minimal load [Min] g	Linearity g	Weighing plate	Quality code	Price excl. of VAT ex works €	Option			
									Verification		DAkkS Calibr. Certificate	
KERN									M	€	DAkkS KERN	€
EW 220-3NM	220	0,001	-	-	± 0,002	A	AB	620,-	-	-	963-127	72,-
EW 420-3NM	420	0,001	-	-	± 0,003	A	AB	690,-	-	-	963-127	72,-
EW 620-3NM	620	0,001	-	-	± 0,003	A	AB	770,-	-	-	963-127	72,-
EW 820-2NM	820	0,01	-	-	± 0,01	B	BB	540,-	-	-	963-127	72,-
EW 2200-2NM	2200	0,01	-	-	± 0,01	C	BB	660,-	-	-	963-127	72,-
EW 4200-2NM	4200	0,01	-	-	± 0,02	C	BB	760,-	-	-	963-127	72,-
EW 6200-2NM	6200	0,01	-	-	± 0,03	C	BB	810,-	-	-	963-128	88,-
EW 12000-1NM	12000	0,1	-	-	± 0,2	C	BB	630,-	-	-	963-128	88,-
Note: For applications that require verification, please order verification at the same time, initial verification at a later date is not possible. Verification at the factory, we need to know the full address of the location of use.												
EG 220-3NM*	220	0,001	0,01	0,02	± 0,002	A	BB	760,-	965-216	66,-	963-127	72,-
EG 420-3NM*	420	0,001	0,01	0,02	± 0,003	A	BB	830,-	965-216	66,-	963-127	72,-
EG 620-3NM*	620	0,001	0,01	0,1	± 0,004	A	BB	930,-	965-201	110,-	963-127	72,-
EG 2200-2NM*	2200	0,01	0,1	0,5	± 0,01	C	BB	820,-	965-216	66,-	963-127	72,-
EG 4200-2NM*	4200	0,01	0,1	0,5	± 0,02	C	BB	880,-	965-216	66,-	963-127	72,-

* ONLY WHILE STOCKS LAST!



Multifunctional laboratory balance with single-cell weighing system and EC type approval [M]

Features

- KERN PBJ: **Internal adjustment** in the case of a change in temperature and time-controlled at defined intervals, guarantees high degree of accuracy and makes the balance independent of its location of use
- KERN PBS: **Adjusting program CAL** for quick setting of the balance accuracy using an external test weight
- **Metal housing:** robust and sturdy
- **Dosage aid:** High-stability mode and other filter settings can be selected
- **Weighing with tolerance range (check-weighing):** a visual signal helps with portioning, dispensing or grading
- **Totalising** of weights
- **Identification number:** 4 digits, printed on calibration protocol freely programmable
- **Automatic data output to the PC/printer** each time the balance is steady

- **1 Draught shield** standard for models with [d] = 0,001 g, weighing space W×D×H 180×193×87 mm
- **Protective working cover** included with delivery

Technical data

- Large backlit LCD display, digit height 14 mm
- Dimensions weighing surface, stainless steel
 - A W×D 108×105 mm
 - B W×D 180×190 mm, see larger picture
- Overall dimensions W×D×H 209×322×78 mm (without draught shield)
- Net weight approx. 3,2 kg
- Permissible ambient temperature 10 °C/30 °C

Accessories

- **Protective working cover**, scope of delivery: 5 items, for models with weighing plate size
 - A KERN PBS-A01S05, € 40,-
 - B KERN PBS-A02S05, € 40,-
- **2 Set for density determination** of liquids and solids with density ≤/≥ 1, for models with weighing plate size
 - A KERN PBS-A04, € 1600,-
 - B KERN PBS-A03, € 1600,-
- **RS-232/Ethernet adapter** for connection to an IP-based Ethernet network, KERN YKI-01, € 290,-
- Further details, plenty of further accessories and suitable printers see *Accessories*

3 Single-cell advanced technology:

- **Fully automatic manufactured weighing cell from one piece of material**
- **Stable temperature behaviour**
- **Short stabilisation time:** steady weight values within approx. 3 s under laboratory conditions
- **Shock proof construction**
- **High corner load performance**

STANDARD

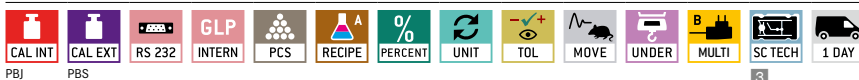

OPTION



FACTORY



Model	Weighing capacity [Max] g	Readability [d] g	Verification value [e] g	Minimal load [Min] g	Linearity g	Weighing plate	Quality code	Price excl. of VAT ex works €	Option			
									Verification		DAkkS Calibr. Certificate	
KERN							QUALITY		M KERN	€	DAkkS KERN	€
PBS 620-3M	620	0,001	-	-	± 0,002	A	BC	1370,-	-	-	963-127	72,-
PBS 4200-2M	4200	0,01	-	-	± 0,02	B	BC	1160,-	-	-	963-127	72,-
PBS 6200-2M	6200	0,01	-	-	± 0,02	B	BC	1390,-	-	-	963-128	88,-
Note: For applications that require verification, please order verification at the same time, initial verification at a later date is not possible. Verification at the factory, we need to know the full address of the location of use.												
PBJ 620-3M	620	0,001	0,01	0,1	± 0,002	A	BC	1610,-	965-201 (U)	110,-	963-127	72,-
PBJ 4200-2M	4200	0,01	0,1	0,5	± 0,02	B	CC	1430,-	965-216 (U)	66,-	963-127	72,-
PBJ 6200-2M	6200	0,01	0,1	1	± 0,02	B	CC	1730,-	965-202 (U)	110,-	963-128	88,-
PBJ 8200-1M	8200	0,1	1	5	± 0,2	B	CC	1420,-	965-217 (U)	77,-	963-128	88,-



04

Robust laboratory and industrial precision scale for heavy items, with EC type approval [M]

Features

- KERN PEJ: **Automatic internal adjustment**, guarantees high degree of accuracy and makes the balance independent of its location of use
- KERN PES: **Adjusting program CAL** for quick setting of the balance accuracy using an external test weight
- **Metal housing:** robust and sturdy
- **Weighing with tolerance range (check-weighing):** Input of two upper and two lower limit values through four arrow keys. An audible and visual signal assists with the portioning, dispensing or grading
- **1 Draught shield** standard for models with [d] = 0,001 g, weighing space W×D×H 170×150×100 mm
- **Underfloor weighing:** load support with loop on the underside of the balance, standard for models with [d] = 0,001 g, hook not included with the delivery

- **Protective working cover** included with delivery

Technical data

- Fluorescent display, bright with high contrast, digit height 14 mm
- Dimensions weighing surface, stainless steel
 - A W×D 140×120 mm
 - B W×D 200×200 mm, see larger picture
 - C W×D 250×220 mm
- Overall dimensions W×D×H, without draught shield
 - A 220×330×90 mm
 - B 220×339×80 mm
 - C 260×330×113 mm
- Permissible ambient temperature 10 °C/30 °C

Accessories

- **Protective working cover**, scope of delivery: 5 items, KERN PES-A04S05, € 40,-
- KERN PES: **Rechargeable battery pack internal**, operating time up to 32 h, without backlight, charging time approx. 15 h, KERN PES-A01, € 610,-
- **Relay output** to connect relays, signal lamps, valves etc., 5 outputs for weighing in 3 tolerance ranges, must be ordered at purchase, KERN PES-A02, € 480,-
- **RS-232/Ethernet adapter** for connection to an IP-based Ethernet network, KERN YKI-01, € 290,-
- Further details, plenty of further accessories and suitable printers see *Accessories*

STANDARD



OPTION

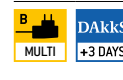

FACTORY

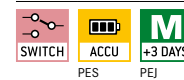

Model	Weighing capacity [Max] g	Readability [d] g	Verification value [e] g	Minimal load [Min] g	Linearity g	Weighing plate	Quality code	Price excl. of VAT ex works €	Option			
									Verification		DAkkS Calibr. Certificate	
KERN							QUALITY	€	M KERN	€	DAkkS KERN	€
PES 620-3M	620	0,001	-	-	± 0,003	A	BB	1280,-	-	-	963-127	72,-
PES 2200-2M	2200	0,01	-	-	± 0,02	B	BB	840,-	-	-	963-127	72,-
PES 4200-2M	4200	0,01	-	-	± 0,02	B	BB	1000,-	-	-	963-127	72,-
PES 6200-2M	6200	0,01	-	-	± 0,03	B	BB	1240,-	-	-	963-128	88,-
PES 15000-1M	15000	0,1	-	-	± 0,2	B	BB	1190,-	-	-	963-128	88,-
PES 31000-1M	31000	0,1	-	-	± 0,4	C	CB	2050,-	-	-	963-128	88,-
Note: For applications that require verification, please order verification on at the same time, initial verification at a later date is not possible. Verification at the factory, we need to know the full address of the location of use.												
PEJ 620-3M	620	0,001	0,01	0,1	± 0,003	A	BB	1480,-	965-201 (M)	110,-	963-127	72,-
PEJ 2200-2M	2200	0,01	0,1	0,5	± 0,02	B	CB	1060,-	965-216 (M)	66,-	963-127	72,-
PEJ 4200-2M	4200	0,01	0,1	0,5	± 0,02	B	CB	1230,-	965-216 (M)	66,-	963-127	72,-

TIPS FROM THE EXPERTS

As well as our balances and test services, we can offer you an extensive range of microscopes and refractometers.

We will offer you reliable quality at fair prices and with the shortest delivery times. Our product specialists will give you professional advice, will work with you to find the right product and will provide comprehensive support after the purchase too.

This ensures a high level of investment security and a good feeling – KERN, the nice balance manufacturer from the wilds of Southern Germany.

For all details on our ranges, please see www.kern-sohn.com or request your own personal catalogues right now: Telephone +49 7433 9933-0



#1 “No compromises with optical device”

KERN offers you a complete, carefully-designed range of biological microscopes, stereo microscopes, metallurgical microscopes, polarisation microscopes, especially flexible, preconfigured stereomicroscope sets, individually configurable stereomicroscope systems as well as microscope cameras and camera software



#2 “High-precision refractive index measurement for laboratories and industry”

Quick and easy determination of measured values, whether on site, in production or in the laboratory, ensuring safety, consistent quality and accelerating processes. This is what KERN's analog and digital refractometers stand for and at an extremely attractive price in consistently high quality.

All microscopes, microscope cameras, refractometers and a variety of practical accessories can be found in the new KERN Catalog of Microscopes & Refractometers 2019.



*Daniel Junger,
Head of Product Management
Optical devices*

Analytical balances

Quick-Finder Analytical balances

Readability [d] mg	Weighing capacity [Max] g		Model KERN	Price excl. of VAT ex works €	Page	DAYS	M	CAL INT	CAL EXT	MEMORY	RS 232	RECIPE
0,01	101		ABT 100-5NM	1900,-	49	1	○	●			●	●
0,01	0,1	42 120	ABT 120-5DNM	2000,-	49	1	○	●			●	●
0,01	0,1	52 120	ABP 100-5DM	2660,-	50	1					●	●
0,01	0,1	82 220	ALJ 200-5DA	1680,-	46	1	○	●			●	●
0,01	0,1	82 220	ABT 220-5DNM	2060,-	49	1	○	●			●	●
0,01	0,1	102 220	ABP 200-5DM	2850,-	50						●	●
0,1		82	ABS 80-4N	920,-	48	1			●		○	●
0,1		82	ABJ 80-4NM	1030,-	48	1	○	●			○	●
0,1		120	ADB 600-C3	610,-	45	1			●		●	●
0,1		120	ADB 100-4	620,-	45	1			●		●	●
0,1		120	ABS 120-4N	1000,-	48	1					○	●
0,1		120	ABJ 120-4NM	1050,-	48	1	○	●	●		○	●
0,1		120	ABT 120-4NM	1450,-	49	1	○	●			●	●
0,1		120	ABP 100-4M	1840,-	50	1					●	●
0,1		160	ALS 160-4A	930,-	46	1			●		●	●
0,1		160	ALJ 160-4A	1050,-	46	1		●			●	●
0,1		160	ALJ 160-4AM	1050,-	46	1	○	●			●	●
0,1		210	ADB 200-4	640,-	45	1			●		●	●
0,1		220	ABS 220-4N	1070,-	48	1			●		○	●
0,1		220	ABJ 220-4NM	1150,-	48	1	○	●			○	●
0,1		220	ABT 220-4NM	1760,-	49	1	○	●			●	●
0,1		220	ABP 200-4M	2220,-	50	1					●	●
0,1		250	ALS 250-4A	980,-	46	1			●		●	●
0,1		250	ALJ 250-4A	1060,-	46	1		●			●	●
0,1		250	ALJ 250-4AM	1090,-	46	1	○	●			●	●
0,1		310	ALJ 310-4A	1170,-	46	1		●			●	●
0,1		320	ABS 320-4N	1200,-	48	1			●		○	●
0,1		320	ABJ 320-4NM	1320,-	48	1	○	●			○	●
0,1		320	ABT 320-4NM	1960,-	49	1	○	●			●	●
0,1		320	ABP 300-4M	2470,-	50	1					●	●
0,1		510	ALJ 500-4A	1860,-	46	1		●			●	●

News 2019

◆ = Carat balances

● = standard

○ = option



Christian D'Onofrio

Product specialist Analytical balances

Tel. +49 7433 9933-147

Fax +49 7433 9933-29147

christian.donofrio@kern-sohn.com

HIGHLIGHT

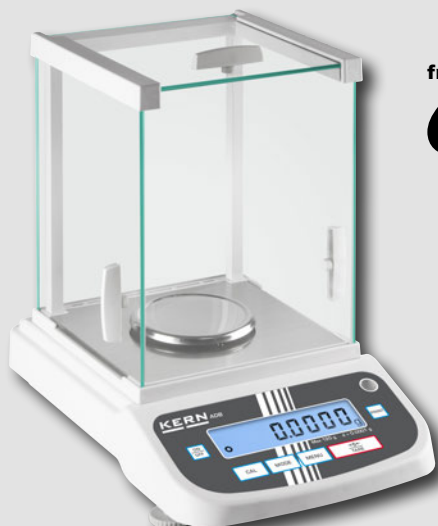

from €

610,-

- Large glass draught shield with 3 sliding doors
- Large weighing capacities at a top price
- Now also available with internal adjustment



The price leader in analytical balances

Features

- **1** ADB 600-C3: Compact, space-saving carat balance with a readout of 0.001 ct and a weighing capacity of 600 ct. The high level of accuracy saves hard cash wherever you are weighing valuable precious stones
- **Adjusting program CAL** for quick setting of the balance accuracy using an external test weight
- Level indicator and foot screws to level the balance precisely, fitted as standard, to give the most accurate weighing results
- **Large glass draught shield** with 3 sliding doors for easy access to the items being weighed.
- **Compact size**, practical for small spaces
- **Simple and convenient 6-key operation**

Technical data

- Large backlit LCD display, digit height 16 mm
- Dimensions weighing surface, stainless steel, \varnothing 90 mm
- Overall dimensions (incl. draught shield) W×D×H
KERN ADB/ADJ: 230×310×330 mm
KERN ADB-C/ADJ-C: 230×310×230 mm
- Weighing space W×D×H
KERN ADB/ADJ: 170×160×205 mm
KERN ADB-C/ADJ-C: 170×160×110 mm
- Net weight approx. 4,4 kg
- Permissible ambient temperature 10 °C/30 °C

Accessories

- **2 Ionizer** to neutralise electrostatic charge, KERN YBI-01A, **€ 940,-**
- **3 Precious stones plate**, aluminium with practical spout, W×D×H 83×66×23 mm, KERN AEJ-A05, **€ 40,-**
- **4 Weighing table** to absorb vibrations and oscillations, which would otherwise distort the weighing result, KERN YPS-03, **€ 990,-**
- **Minimum weight of sample**, smallest weight to be weighed, depending on the required process accuracy, only in combination with a DAkkS calibration certificate, KERN 969-103, **€ 10,-**
- Further details, plenty of further accessories and suitable printers see *Accessories*

STANDARD

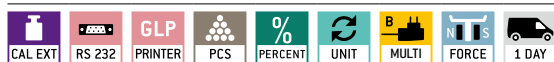

OPTION



Model	Weighing capacity [Max] g	Readability [d] mg	Reproducibility mg	Linearity mg	Price excl. of VAT ex works €	Option	
						DAkkS KERN	DAkkS Calibr. Certificate €
ADB 100-4	120	0,1	0,2	± 0,4	620,-	963-101	138,-
ADB 200-4	210	0,1	0,2	± 0,4	640,-	963-101	138,-
ADB 600-C3	120 g 600 ct	0,1 mg 0,001 ct	0,2 mg 0,002 ct	± 0,4 mg ± 0,004 ct	610,-	963-101	138,-



1 KERN ALJ 200-5DA with optional ionisor 2, see Accessories

Analytical balance range with large weighing capacities – now also with EC type approval [M] or available as semi-micro analytical balance

Features

- 1 ALJ 200-5DA: High-precision semi-micro analytical balance
- 2 ALJ-A03: Ionizer to neutralise electrostatic charge for fixed installation in the analytical balance. Particularly convenient handling as you no longer need a separate device. Simply enable the ionizer fan at the push of a button. Suitable for all models
- KERN ALJ-A/-AM: **Automatic internal adjustment** in the case of a change in temperature $\geq 1,2$ °C or timecontrolled every 3 h, guarantees high degree of accuracy and makes the balance independent of its location of use
- KERN ALS-A: **Adjusting program CAL** for quick setting of the balance accuracy using an external test weight
- **Ergonomically optimised keypad** for left and righthanded users
- **Large glass draught shield** with 3 sliding doors for easy access to the items being weighed.
- **Compact size**, practical for small spaces
- **Protective working cover** included with delivery

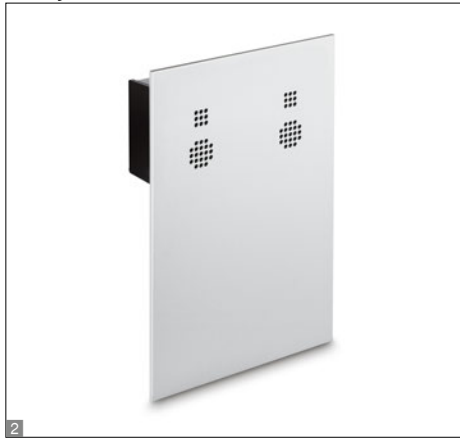

Technical data

- Backlit LCD display, digit height 17 mm
- Dimensions weighing surface, stainless steel, \varnothing 80 mm
- Overall dimensions (incl. draught shield) W×D×H 210×340×330 mm
- Weighing space W×D×H 160×140×205 mm
- Net weight 7 kg
- Permissible ambient temperature
KERN ALS-A/ALJ-A/ALJ-DA: 5 °C/35 °C
KERN ALJ-AM: 15 °C/30 °C

Accessories

- **Protective working cover**, scope of delivery: 5 items, KERN ALJ-A01S05, **€ 40,-**
- Protective dust cover, KERN ABS-A08, **€ 30,-**
- **2 Draft shield rear panel with integrated ionizer** to neutralise electrostatic charge. Is fitted in place of the existing glass rear panel of the draft shield. Suitable for all models in the KERN ALS-A/ALJ-A/ALJ-AM/ ALJ-DA range, please order at the time you order your balance, the scope of delivery is the rear panel, ionizer, power supply. Factory Option, KERN ALJ-A03, **€ 620,-**
- **3 Set for density determination** of liquids and solids with density $\leq/\geq 1$, the density is indicated directly on the display, KERN YDB-03, **€ 390,-**

- **4 Weighing table** to absorb vibrations and oscillations, which would otherwise distort the weighing result, KERN YPS-03, **€ 990,-**
- **Minimum weight of sample**, smallest weight to be weighed, depending on the required process accuracy, only in combination with a DAkkS calibration certificate, KERN 969-103, **€ 10,-**
- **Equipment qualification:** compliant qualification concept which includes the following validation services, Installation Qualification (IQ), Operating Qualification (OQ), KERN 961-231B, **€ 750,-**
- Further details, plenty of further accessories and suitable printers see *Accessories*

STANDARD

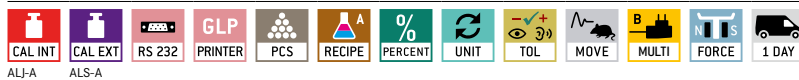

OPTION



FACTORY



Model	Weighing capacity [Max] g	Readability [d] mg	Verification value [e] mg	Minimal load [Min] mg	Reproducibility mg	Linearity mg	Price excl. of VAT ex works €	Option			
								Verification		DAkkS Calibr. Certificate	
KERN								MD KERN	€	DAkkS KERN	€
ALS 160-4A	160	0,1	-	-	0,1	± 0,3	930,-	-	-	963-101	138,-
ALS 250-4A	250	0,1	-	-	0,1	± 0,3	980,-	-	-	963-101	138,-
Note: For applications that require verification, please order verification at the same time, initial verification at a later date is not possible. Verification at the factory, we need to know the full address of the location of use.											
ALJ 200-5DA	82 220	0,01 0,1	1	1	0,02 0,1	± 0,03 0,3	1680,-	-	-	963-101	138,-
ALJ 160-4A	160	0,1	-	-	0,1	± 0,3	1030,-	-	-	963-101	138,-
ALJ 160-4AM	160	0,1	1	10	0,2	± 0,3	1060,-	965-201	110,-	963-101	138,-
ALJ 250-4A	250	0,1	-	-	0,1	± 0,3	1060,-	-	-	963-101	138,-
ALJ 250-4AM	250	0,1	1	10	0,2	± 0,3	1090,-	965-201	110,-	963-101	138,-
ALJ 310-4A	310	0,1	-	-	0,1	± 0,3	1170,-	-	-	963-101	138,-
ALJ 500-4A	510	0,1	-	-	0,2	± 0,4	1860,-	-	-	963-101	138,-

Price reduction



Accessories

- **Protective working cover**, scope of delivery: 5 items, KERN ACS-A02S05, € 40,-
- **1 Set for density determination** of liquids and solids with density $\leq/\geq 1$, the density is indicated directly on the display, KERN YDB-03, € 390,-
- **2 Ionizer** to neutralise electrostatic charge, KERN YBI-01A, € 940,-
- **Data interface RS-232**, interface cable included, approx. 1,5 m KERN ACS-A01, € 90,-
- **3 Weighing table** to absorb vibrations and oscillations, which would otherwise distort the weighing result, KERN YPS-03, € 990,-
- **Minimum weight of sample**, smallest weight to be weighed, depending on the required process accuracy, only in combination with a DAkkS calibration certificate, KERN 969-103, € 10,-
- Further details, plenty of further accessories and suitable printers see *Accessories*

The bestseller in analytical balances, with high-quality single-cell weighing system, also with EC type approval [M]

Features

- **ABJ-NM: Automatic internal adjustment** in the case of a change in temperature $\geq 2\text{ }^\circ\text{C}$ or timecontrolled every 4 h, guarantees high degree of accuracy and makes the balance independent of its location of use
- **ABS-N: Adjusting program CAL** for quick setting of the balance accuracy using an external test weight
- **Dosage aid:** High-stability mode and other filter settings can be selected
- **Simple recipe weighing and documenting** with a combined tare/print function. In addition, the ingredients for the recipe are numbered automatically and printed out with their corresponding number and nominal weight
- **Automatic data output to the PC/printer** each time the balance is steady

- **Identification number:** 4 digits, printed on calibration protocol freely programmable
- ABJ-NM has OIML certification
- **Protective working cover** included with delivery

Technical data

- Large LCD display, digit height 14 mm
- Dimensions weighing surface, stainless steel, $\varnothing 91\text{ mm}$
- Overall dimensions (incl. draught shield) WxDxH 210x340x325 mm
- Weighing space WxDxH 174x162x227 mm
- Net weight approx. 6 kg
- Permissible ambient temperature $10\text{ }^\circ\text{C}/30\text{ }^\circ\text{C}$

- 4 Single-cell advanced technology:**
- **Fully automatic manufactured weighing cell from one piece of material**
 - **Stable temperature behaviour**
 - **Short stabilisation time:** steady weight values within approx. 3 s under laboratory conditions
 - **Shock proof construction**
 - **High corner load performance**

STANDARD

CAL INT	CAL EXT	GLP	PCS	RECIPE	PERCENT	UNIT	TOL	MULTI	SC TECH	1 DAY
---------	---------	-----	-----	--------	---------	------	-----	-------	---------	-------

ABJ-NM ABS-N

OPTION

RS 232	DAkkS
--------	-------

+3 DAYS

FACTORY

M

+3 DAYS

ABJ-NM

Model	Weighing capacity [Max] g	Readability [d] mg	Verification value [e] mg	Minimal load [Min] mg	Reproducibility mg	Linearity mg	Price excl. of VAT ex works €	Option			
								Verification		DAkkS Calibr. Certificate	
								KERN	€	DAkkS KERN	€
ABS 80-4N	82	0,1	-	-	0,2	$\pm 0,3$	920,-	-	-	963-101	138,-
ABS 120-4N	120	0,1	-	-	0,2	$\pm 0,3$	1000,-	-	-	963-101	138,-
ABS 220-4N	220	0,1	-	-	0,2	$\pm 0,3$	1070,-	-	-	963-101	138,-
ABS 320-4N	320	0,1	-	-	0,2	$\pm 0,3$	1200,-	-	-	963-101	138,-
Note: For applications that require verification, please order verification at the same time, initial verification at a later date is not possible. Verification at the factory, we need to know the full address of the location of use.											
ABJ 80-4NM	82	0,1	1	10	0,2	$\pm 0,3$	1030,-	965-201	110,-	963-101	138,-
ABJ 120-4NM	120	0,1	1	10	0,2	$\pm 0,3$	1050,-	965-201	110,-	963-101	138,-
ABJ 220-4NM	220	0,1	1	10	0,2	$\pm 0,3$	1150,-	965-201	110,-	963-101	138,-
ABJ 320-4NM	320	0,1	1	10	0,2	$\pm 0,3$	1320,-	965-201	110,-	963-101	138,-

Price reduction



The premium model with single-cell weighing system

Features

- **Automatic internal adjustment** in the case of a change in temperature $\geq 0,5$ °C or timecontrolled every 4 h, guarantees high degree of accuracy and makes the balance independent of its location of use
- **Dosage aid:** High-stability mode and other filter settings can be selected
- **Simple recipe weighing and documenting** with a combined tare/print function. In addition, the ingredients for the recipe are numbered automatically and printed out with their corresponding number and nominal weight
- **Identification number:** 4 digits, printed on calibration protocol freely programmable
- **Automatic data output to the PC/printer** each time the balance is steady
- **Large glass draught shield** with 3 sliding doors for easy access to the items being weighed.
- **Protective working cover** included with delivery

Technical data

- Large LCD display, digit height 14 mm
- Dimensions weighing surface, stainless steel, \varnothing 80 mm
- Overall dimensions (incl. draught shield) W×D×H 217×356×338 mm
- Weighing space W×D×H 168×172×223 mm
- Net weight approx. 7 kg
- Permissible ambient temperature 10 °C/30 °C



Accessories

- **Protective working cover**, scope of delivery: 5 items, KERN ABT-A02S05, **€ 40,-**
- **1 Set for density determination** of liquids and solids with density $\leq/\geq 1$, the density is indicated directly on the display, KERN YDB-03, **€ 390,-**
- **2 Ionizer** to neutralise electrostatic charge, KERN YBI-01A, **€ 940,-**
- **3 Weighing table** to absorb vibrations and oscillations, which would otherwise distort the weighing result, KERN YPS-03, **€ 990,-**
- **Minimum weight of sample**, smallest weight to be weighed, depending on the required process accuracy, only in combination with a DAkkS calibration certificate, KERN 969-103, **€ 10,-**
- Further details, plenty of further accessories and suitable printers see *Accessories*

4 Single-cell advanced technology:

- **Fully automatic manufactured weighing cell from one piece of material**
- **Stable temperature behaviour**
- **Short stabilisation time:** steady weight values within approx. 4 s under laboratory conditions
- **Shock proof construction**
- **High corner load performance**

STANDARD

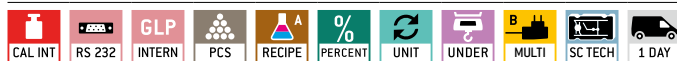

OPTION



FACTORY



Model	Weighing capacity [Max] g	Readability [d] mg	Verification value [e] mg	Minimal load [Min] mg	Reproducibility mg	Linearity mg	Price excl. of VAT ex works €	Option			
								Verification		DAkkS Calibr. Certificate	
KERN							MT KERN	€	DAkkS KERN	€	
ABT 120-4NM	120	0,1	1	10	0,1	± 0,2	1450,-	965-201	110,-	963-101	138,-
ABT 220-4NM	220	0,1	1	10	0,1	± 0,2	1760,-	965-201	110,-	963-101	138,-
ABT 320-4NM	320	0,1	1	10	0,1	± 0,3	1960,-	965-201	110,-	963-101	138,-
ABT 100-5NM	101	0,01	1	1	0,05	± 0,15	1900,-	965-201	110,-	963-101	138,-
Note: For applications that require verification, please order verification at the same time, initial verification at a later date is not possible. Verification at the factory, we need to know the full address of the location of use.											
Dual-range balance switches automatically to the next largest weighing capacity [Max] and readability [d]											
ABT 120-5DNM	42 120	0,01 0,1	1	1	0,02 0,1	± 0,05 0,2	2000,-	965-201	110,-	963-101	138,-
ABT 220-5DNM	82 220	0,01 0,1	1	1	0,05 0,1	± 0,1 0,2	2060,-	965-201	110,-	963-101	138,-

Price reduction

NEW **PREMIUM**
★★★★



1 KERN ABP 100-5DM with optional ionizer

1 NEW: Extremely fast ionization process, thanks to the latest generation of KERN ionization technology to neutralise electrostatic charge for fixed installation in the analytical balance. Particularly convenient handling as you no longer need a separate device. Simply enable the ionizer fan at the push of a button. Suitable for all models

Premium analytical balance with the latest Single-Cell Generation for extremely rapid, stable weighing results



Bright OLED display with large viewing angle for the very best readout from a wide range of lines of sight or poor lighting conditions



USB data interfaces and RS-232 for transferring weighing data to the PC, tablet, printer, USB as well as connecting external devices, such as barcode scanner (option), numeric keypad (option) etc.



GLP/ISO record keeping professional and detailed GLP protocol, so that the scale is fully compliant with the relevant standard requirements according to ISO, GLP and GMP

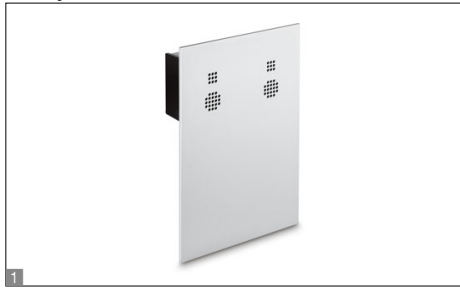

Features

- This new generation of analytical balances combines the highest level of precision with large weighing capacities. Thanks to the new Single-Cell Generation, the weighing result is displayed in a fraction of the time with comparable models. Together with the intuitively structured menu, this means that you can work efficiently and rapidly
- **Navigation pad** for super quick navigating through the menus
- **Automatic internal adjustment** in the case of a change in temperature $\geq 1\text{ }^{\circ}\text{C}$ or timecontrolled every 4 h, guarantees high degree of accuracy and makes the balance independent of its location of use. For applications which do not require verification the time interval can be individually adjusted
- The **Minimum weight of sample** can be manually stored in the device or automatically calculated. For weighings below this value, the balance issues a warning message
- **Dosage aid:** High-stability mode and other filter settings can be selected
- **Simple recipe weighing and documenting** with a combined tare/print function. In addition, the ingredients for the recipe are numbered automatically and printed out with their corresponding number and nominal weight
- **Individual user settings for up to 10 users can be saved:** user name/user number (can be printed out or added to the record for each process), password, menu language, user profiles, accessing user settings via barcode, additional guest mode for users who are not logged in, authorizations, eg. B. balance adjustment, changing settings or conditioning or modification of a recipe only by the authorized person & performing the formulation by the user

- **U.S. FDA 21 Part 11:** assists you in data integrity in accordance with U.S. Pat. FDA 21 Part 11 (for example (weighing result, sample ID, user name, scales ID, ...))
- Menu language DE, GB
- **Automatic data output to the PC/printer** each time the balance is steady
- **Large glass draught shield** with 3 sliding doors for easy access to the items being weighed.
- **Multi-function weighing plate** included with delivery, minimises the effect of currents of air in the weighing space and therefore significantly improves the stabilization time and repeatability. In addition samples, sample paper, PCR containers, micro centrifuge tubes and many other items which protrude can be easily fixed in place and weighed easily
- **Protective working cover included with delivery**

Technical data

- Luminescent OLED display, digit height 14 mm, bright with high contrast, for easy reading of the weight, even in poor lighting conditions
- Dimensions weighing surface \varnothing 91 mm
- Overall dimensions (incl. draught shield) WxDxH 213x407x344 mm
- Weighing space WxDxH 166x156x220 mm
- Net weight approx. 8 kg
- Permissible ambient temperature $10\text{ }^{\circ}\text{C}/30\text{ }^{\circ}\text{C}$

Accessories

- **Protective working cover**, scope of delivery: 5 items, KERN YBA-A06S05, **€ 40,-**
- **Draft shield rear panel with integrated ionizer** to neutralise electrostatic charge. Is fitted in place of the existing glass rear panel of the draft shield. Suitable for all models in the KERN ABP range, please order at the time you order your balance, the scope of delivery is the rear panel, ionizer, power supply. Factory Option, KERN ABP-A01, **€ 1710,-**
- **Weighing table** to absorb vibrations and oscillations, which would otherwise distort the weighing result, KERN YPS-03, **€ 990,-**
- **Minimum weight of sample**, smallest weight to be weighed, depending on the required process accuracy, only in combination with a DAkkS calibration certificate, KERN 969-103, **€ 10,-**
- **Equipment qualification:** compliant qualification concept which includes the following validation services, Installation Qualification (IQ), Operating Qualification (OQ), KERN 961-231B, **€ 750,-**
- Further details, plenty of further accessories and suitable printers see *Accessories*

Single-cell advanced technology:

- **Fully automatic manufactured weighing cell from one piece of material**
- **Stable temperature behaviour**
- **Short stabilisation time:** steady weight values within approx. 2 s! (models with [d] = 0,1 mg), approx. 8 s! (models with [d] = 0,01 mg) under laboratory conditions
- **Shock proof construction**
- **High corner load performance**

STANDARD

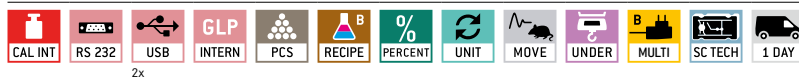

OPTION



FACTORY



Model	Weighing capacity [Max] g	Readability [d] mg	Verification value [e] mg	Minimal load [Min] mg	Reproducibility mg	Linearity mg	Price excl. of VAT ex works €	Option			
								Verification		DAkkS Calibr. Certificate	
KERN								M KERN	€	DAkkS KERN	€
ABP 100-4M	120	0,1	1	10	0,1	$\pm 0,2$	1840,-	965-201	110,-	963-101	138,-
ABP 200-4M	220	0,1	1	10	0,1	$\pm 0,2$	2220,-	965-201	110,-	963-101	138,-
ABP 300-4M	320	0,1	1	10	0,1	$\pm 0,3$	2470,-	965-201	110,-	963-101	138,-
Dual-range balance switches automatically to the next largest weighing capacity [Max] and readability [d]											
ABP 100-5DM	52 120	0,01 0,1	1	1	0,02 0,1	$\pm 0,03$ 0,3	2660,-	965-201	110,-	963-101	138,-
ABP 200-5DM	102 220	0,01 0,1	1	1	0,02 0,1	$\pm 0,03$ 0,3	2850,-	965-201	110,-	963-101	138,-

Note: For applications that require verification, please order verification at the same time, initial verification at a later date is not possible. Verification at the factory, we need to know the full address of the location of use.



TIPS FROM THE EXPERTS

As well as our balances and test services, we can offer you an extensive range of medical scales.

We will offer you reliable quality at fair prices and with the shortest delivery times. Our product specialists will give you professional advice, will work with you to find the right product and will provide comprehensive support after the purchase too.

This ensures a high level of investment security and a good feeling – KERN, the nice balance manufacturer from the wilds of Southern Germany.

For all details on our ranges, please see www.kern-sohn.com or request your own personal catalogues right now: Telephone +49 7433 9933-0

#3 “Medical products from KERN – products you can rely on”

For years an established name in hospitals, doctors’ surgeries, rehabilitation clinics and nursing homes.

Wherever reliable quality is important, look no further than the complete KERN range of medical scales, from baby scales, to personal scales, chair scales, obesity scales through to hand grip dynamometers.

KERN 2019 catalogue for medical balances and devices – this is where you will find everything for day-to-day tasks in the medical environment!



*Hendrik Neff, product specialist
Medical scales*



Moisture analysers

Moisture analysing is an integral part of production and processing of many raw and finished products and has a crucial impact on the quality of the product.

Moisture analysers are used particularly in the food industry, water resource management (sewage plants, etc.), plastics industry, agriculture and the energy industry (bio-energy plants, etc.).

Determining moisture requires a great deal of experience. Depending on the type of sample and the task involved, various drying processes are used.

KERN has concentrated on the most widely-used drying method: halogen drying, which brings many advantages:

- Sample is evenly warmed from above, without risk of burning the sample surface
- Affordable purchase costs ensure rapid amortisation of the device
- Most common temperature ranges from 35 – 200 °C
- High measuring precision, up to 0.01 %
- Sufficient buffer capacity, weighing capacity up to 200 g
- Various drying programs (soft drying, standard drying, drying in levels, rapid drying (Boost))

The numerous memories of the KERN moisture analyser are particularly useful, as they hold information on the complete drying processes with drying parameters such as drying time, drying period, drying temperature, display settings, switch off criteria, etc. This saves an enormous amount of time and helps to achieve repeatable results.

On the internet, you will find a practical application handbook containing many examples, field reports, settings and tips for each KERN moisture analyser.





Determination of drying parameters

We would be pleased to carry out individual analyses on the sample you submit, which will help you when setting the parameters of your moisture analyser and will lead to results which can be reproduced. KERN 965-243, € 95,-/hour

Temperature calibration by KERN moisture analysers (factory calibration certificate)

In order to guarantee the comparability of the results of moisture analyses it is crucial that the heating chamber and therefore the sample are maintained at the correct temperature. Over time, for example, deposits or dirt can contaminate the heating chamber of the moisture analyser and this can distort the measuring results. It is therefore necessary to carry out regular temperature calibration. KERN 964-305, € 140,-

Quick-Finder Moisture analysers

Readability [d] g	Weighing capacity [Max] g	Model KERN	Price excl. of VAT ex works €	Page	 DAYS	 CAL EXT	 MEMORY	 RS 232
0,001	60	DBS 60-3	1270,-	55	1	●	●	●
0,001	110	DAB 100-3	1050,-	54	1	●	●	●
0,001	160	DLB 160-3A	1170,-	56	1	●	●	●
0,01	200	DAB 200-2	930,-	54	1	●	●	●

□ News 2019

● = standard ○ = option

Jesús Martínez

Product specialist Moisture analysers

Tel. +49 7433 9933-209

Fax +49 7433 9933-29209

jesus.martinez@kern-sohn.com



HIGHLIGHT



from €
930,-

- Powerful halogenquartz glass heater 400 W, alternatively also available with infrared quartz glass heater
- High level of process reliability thanks to drying programs which can be stored
- Now also available as 10 mg version for quick tests and sampling tests

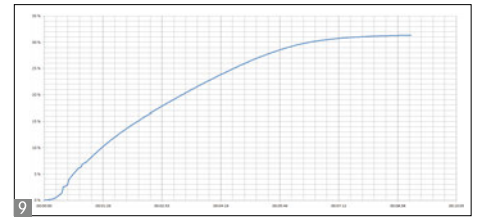
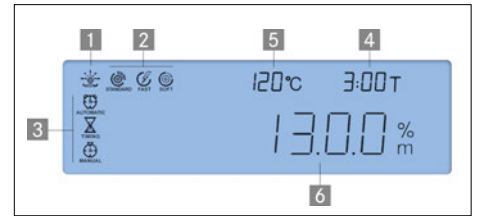

Moisture analyser which is particularly easy to use – now also as a version with [d] = 10 mg, ideal for recurring rapid tests

Features

- **NEW:** KERN DAB 200-2! Version with lower resolution, whereby the switch-off criterion is reached faster, which saves time. Ideal for quick tests and spot checks
- Backlit graphic display, digit height 14 mm
- 1 Drying process active
- 2 Active heating profile
- 3 Active switch-off criteria
- 4 Previous drying time
- 5 Current temperature
- 6 Current moisture content in %

- **Halogen quartz glass heater** 400 W
- **Observation window above the sample**, useful during initial setting
- **Internal memory** for automatic sequence of 15 complete drying processes and 5 drying processes carried out
- The last value measured remains on the display until it is replaced by a new measurement
- **50 sample plates included**

- **Application handbook:** On the internet, you will find a practical application handbook containing many examples, field reports, settings and tips for each KERN moisture analyser

STANDARD

CAL EXT | MEMORY | RS 232 | GLP | PRINTER | UNIT | 230 V | DMS | 1 DAY

OPTION

DAkKS | +3 DAY

Model KERN	DAB 200-2 <small>NEW</small>	DAB 100-3
Readability [d]	0,01 g/0,05 %	0,001 g/0,01 %
Weighing capacity [Max]	200 g	110 g
Reproducibility weight of sample 2 g	1,5 %	0,15 %
Reproducibility, weight of sample 10 g	0,3 %	0,02 %
Display after drying (Display can be switched over at any time)		
Moisture [%] = Moisture content (M) from wet weight (W)	0 - 100 %	
Dry content [%] = Dry weight (D) from W	100 - 0 %	
Moisture content (M)	Absolute value in [g]	
Temperature range	40 °C - 199 °C in steps up to 1 °C	
Drying modes	<input type="checkbox"/> Standard drying <input type="checkbox"/> Gentle drying <input type="checkbox"/> Rapid drying	
Switch-off criteria	• Automatic switch-off (2 mg loss in weight in 45 s) • Time controlled switch-off (3 min - 99 min 59 s, 10 s increments) • Manual switch-off at the press of a button	
Recall of measurement/ Log output	Interval can be set from 1 s - 10 min (Only when used with printer KERN YKB-01N or PC)	
Overall dimensions WxDxH	240x365x180 mm	
Net weight	4,82 kg	
Price €, excl. of VAT, ex works	930,-	1050,-
Option DAkKS Calibr. Certificate	Mass: KERN 963-127, € 72,-	
Option Factory Calibr. Certificate	Temperature: KERN 964-305, € 140,-	

NEW New model

Accessories

- **Sample plates aluminium**, ø 90 mm, unit of 80 pieces, KERN MLB-A01A, € 45,-
- **Round fiberglass filter** high mechanical stability, with organic binder, box of 100 pieces, KERN RH-A02, € 80,-
- **Round fiberglass filter**, medium mechanical stability, without organic binder, box of 100 pieces, KERN YMF-A01, € 25,-
- **7 Temperature calibration set** consists of measuring sensor and display device, KERN DAB-A01., € 110,-
- **8 Infrared quartz glass heater**, Factory Option, KERN DAB-A02, € 95,-
- **RS-232/Ethernet adapter** for connection to an IP-based Ethernet network, KERN YKI-01, € 290,-
- **RS-232/Bluetooth adapter** to connect to Bluetooth capable devices, such as Bluetooth printers, tablets, laptops, smartphones, etc., KERN YKI-02, € 220,-
- **RS-232/WiFi adapter** for wireless connection to networks and WLAN capable devices, such as tablets, laptops or smartphones, KERN YKI-03, € 690,-
- **9 Display of the drying process** in conjunction with BalanceConnection, KERN SCD-4.0, € 150,-
- **Thermal printer**, KERN YKB-01N, € 320,-

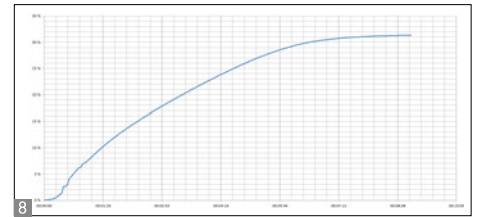
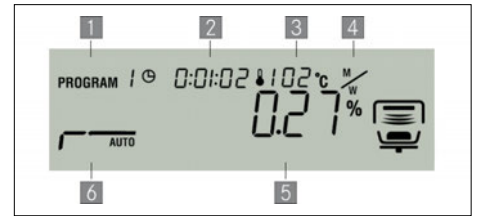

Moisture analyser with graphics display and 10 memories for drying programs

Features

- Backlit graphic display, digit height 15 mm
 - 1 Drying process active
 - 2 Previous drying time
 - 3 Current temperature
 - 4 Unit for displaying the results
 - 5 Current moisture content in %
 - 6 Active heating profile
- **Halogen quartz glass heater** 400 W

- **Observation window above the sample**, useful during initial setting
- **Internal memory** for automatic sequence of 10 complete drying processes and 100 drying processes carried out
- The last value measured remains on the display until it is replaced by a new measurement

- **Sample description** for up to 99 samples, 2 digits, freely programmable, and is printed in the measuring protocol
- **Date and time display** as standard
- **10 sample plates included**
- **Protective working cover** included with delivery
- **Application handbook:** On the internet, you will find a practical application handbook containing many examples, field reports, settings and tips for each KERN moisture analyser

STANDARD



OPTION

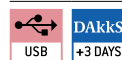

Modell KERN	DBS 60-3
Readability [d]	0,001 g/0,01 %
Weighing capacity [Max]	60 g
Reproducibility weight of sample 2 g	0,15 %
Reproducibility, weight of sample 10 g	0,02 %
Display after drying	
Moisture [%] = Moisture content (M) from wet weight (W)	0-100 %
Dry content [%] = Dry weight (D) from W	100-0 %
ATRO [%] [(W-D) : D] · 100%	0-999 %
Moisture content (M)	Absolute value in [g]
Temperature range	50 °C-200 °C in steps up to 1 °C
Drying modes	<input type="checkbox"/> Standard drying <input type="checkbox"/> Drying in levels <input type="checkbox"/> Gentle drying <input type="checkbox"/> Rapid drying
Switch-off criteria	• Automatic unrestricted switch-off (Selectable loss in weight 0,01%-0,1% in 30 s) • Time controlled switch-off (1 min - 12 h) • Manual switch-off at the press of a button
Recall of measurement/ Log output	Interval can be set from 1 s - 10 min (Only when used with printer KERN YKB-01N or PC)
Overall dimensions WxDxH	204x336x167 mm
Net weight	approx. 4,6 kg
Price €, excl. of VAT, ex works	1270,-
Option DAkkS Calibr. Certificate	Mass: KERN 963-127, € 72,-
Option Factory Calibr. Certificate	Temperature: KERN 964-305, € 140,-

Accessories

- **Protective working cover**, scope of delivery: 5 items, KERN DBS-A03S05, € 40,-
- **Sample plates aluminium**, ø 90 mm, unit of 80 pieces, KERN MLB-A01A, € 45,-
- **Round fiberglass filter** high mechanical stability, with organic binder, box of 100 pieces, KERN RH-A02, € 80,-
- **Temperature calibration set** consists of measuring sensor and display device, KERN DBS-A01., € 450,-
- **USB interface kit** for bi-directional data exchange between balance/moisture analyser and computer. Scope of delivery: USB cable, driver, Software Balance Connection, KERN DBS-A02, € 290,-
- **Display of the drying process** in conjunction with BalanceConnection, KERN SCD-4.0, € 150,-
- **Thermal printer**, KERN YKB-01N, € 320,-
- **Matrix needle printer**, to print the weights on normal paper, ideal for long-term archiving, KERN 911-013, € 390,-
- **Label printer**, KERN YKE-01, € 590,-

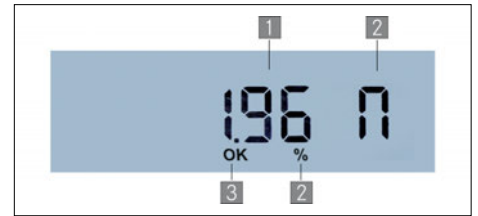

06

The moisture analyser for heavy, high-volume samples

Features

- Backlit LCD display, digit height 17 mm
 - 1 Current moisture content in %
 - 2 Unit for displaying the results
 - 3 Drying process active
- **Halogen quartz glass heater** 400 W
- **Internal memory** for automatic sequence of 5 complete drying processes

- The last value measured remains on the display until it is replaced by a new measurement
- **10 sample plates included**
- **Protective working cover** included with delivery
- **Application handbook:** On the internet, you will find a practical application handbook containing many examples, field reports, settings and tips for each KERN moisture analyser

Accessories

- **Protective working cover**, scope of delivery: 5 items, KERN ALJ-A01S05, **€ 40,-**
- **Sample plates aluminium**, \varnothing 90 mm. unit of 80 pieces, KERN MLB-A01A, **€ 45,-**
- **4 Round fiberglass filter** high mechanical stability, with organic binder, box of 100 pieces, KERN RH-A02, **€ 80,-**
- **Round fiberglass filter**, medium mechanical stability, without organic binder, box of 100 pieces, KERN YMF-A01, **€ 25,-**
- **4 Temperature calibration set** consists of measuring sensor and display device, KERN DLB-A01N., **€ 460,-**
- **Thermal printer**, KERN YKB-01N, **€ 320,-**
- **Matrix needle printer**, to print the weights on normal paper, ideal for long-term archiving, KERN 911-013, **€ 390,-**

STANDARD



OPTION



Modell KERN	DLB 160-3A
Readability [d]	0,001 g/0,01 %
Weighing capacity [Max]	160 g
Reproducibility, weight of sample 10 g	0,05 %
Display after drying (Display can be switched over at any time)	
Moisture [%] = Moisture content (M) from wet weight (W)	0-100 %
Dry content [%] = Dry weight (D) from W	100-0 %
ATRO [%] [(W-D) : D] · 100%	0-999 %
Moisture content (M)	Absolute value in [g]
Temperature range	35 °C-160 °C in steps up to 1 °C
Drying modes	<input checked="" type="checkbox"/> Standard drying <input checked="" type="checkbox"/> Rapid drying, Vorheizstufe zuschaltbar
Switch-off criteria	<ul style="list-style-type: none"> • Automatic unrestricted switch-off (Selectable loss in weight 0,1%-9,9% in 60 s) • Time controlled switch-off (1 min - 99 min) • Manual switch-off at the press of a button
Log output	<ul style="list-style-type: none"> • Continuous output (residual weight) • At the end of the drying process, manual or automatic (Only in connection with KERN YKB-01N printer or PC)
Overall dimensions WxDxH	210x340x225 mm
Net weight	approx. 4,2 kg
Price €, excl. of VAT, ex works	1 170,-
Option DAkkS Calibr. Certificate	Mass: KERN 963-127, € 72,-
Option Factory Calibr. Certificate	Temperature: KERN 964-305, € 140,-

Bench scales

Compact industrial weighing technology

Thanks to their compact dimensions, low weight, robust internal mechanism and the fact that they can be operated independent of mains power, bench scales can be used not only in a stationary situation, but also as mobile scales.

With weighing ranges between 3 kg and 65 kg, bench scales can cover a wide range of applications. Whether as a commissioning scale in the warehouse, for inventory purposes, on a production work station, in quality control, in small workshops, in service cars or in sales offices, bench scales are the first choice.

Durable stainless steel weighing plates, easy to read backlit displays, useful functions such as piece counting, PRE-TARE – subtraction of a known container weight, or ► **interfaces** to PC and printer, all these support the users in their daily work.

► **Dual range** scales cover a particularly wide range of applications. With these scales, the total weighing range is divided into 2 subranges and begins with a high resolution read-out in the fine weighing range. If this range is exceeded the balance automatically switches to the higher weighing range with the lower resolution read-out.

All KERN bench scales have an adjustment program (CAL) to adjust the accuracy. In this way, the high level of accuracy is guaranteed at all times, even during harsh everyday use. Find the right test weights for you, see page 170.

Touchscreen balances

The newest development for an even greater level of user-friendliness is the intuitive touchscreen operation, which is being integrated into new KERN models, see page 66/67 (FKT), 110/111 (IKT).

NOTE: a high-quality touchscreen bench scale range (KERN GAT, page 68/69) and touchscreen platform scale range (KERN IFT, page 112/113). Thanks to the intuitive touchscreen concept and multi-lingual operation (DE, GB, IT, ES, PT, NL, FI, PL, RUS, SE, CZ) the balances can be used easily by inexperienced users, straightaway. For the professional user, the balances also provide convenient functions which permit a high level of individualisation and which thereby make operation significantly easier and quicker. Through a large memory, e.g. for item master data, weighing data etc. the balances are the ideal solution when working with a large range of goods or where there are high requirements for record keeping and documentation. Thanks to the high level of connectivity it is easy to connect barcode readers for item recognition, USB sticks for data storage or data transfer to PCs and networks using RS 232 or USB and this means that this range can be used for many different functions in Industry 4.0 applications.

► **See the glossary on page 206–208**

Edeltraud Semma-Hauser

Product specialist Bench scales

Tel. +49 7433 9933-140

Fax +49 7433 9933-29140

semma-hauser@kern-sohn.com



HIGHLIGHT



only €

185,-

- Simple and convenient 5-key operation
- Very fast display
- High mobility

Quick-Finder Bench scales

Readability [d] g	Weighing range [Max] kg	Weighing plate W×D mm	Model KERN	Price excl. of VAT ex works €	Page													
						For an explanation on the pictos, see the front flap												
0,02	6	340×240	FKB 6K0.02	520,-	65	1		●										
0,02	6	340×240	FKT 6K0.02L	890,-	66	1		●	●	●	●	●						
0,05	6	294×225	GAB 6K0.05N	295,-	64	1		●										
0,05	8	340×240	FKB 8K0.05	480,-	65	1		●										
0,05	16	340×240	FKB 16K0.05	580,-	65	1		●										
0,05	16	340×240	FKT 16K0.05L	890,-	66	1		●	●	●	●	●						
0,1	3	253×228	FCF 3K-4	185,-	61	1		●										
0,1	3	253×229	FCB 3K0.1	215,-	62	1		●										
0,1	8	252×228	FCB 8K0.1	240,-	62	1		●										
0,1	8	340×240	FKB 8K0.1A	300,-	63	1		●										
0,1	12	294×225	GAB 12K0.1N	295,-	64	1		●										
0,1	16	340×240	FKB 16K0.1	480,-	65	1		●										
0,1	36	340×240	FKB 36K0.1	550,-	65	1		●										
0,1	36	340×240	FKT 36K0.1L	890,-	66	1		●	●	●	●	●						
0,2	6	300×225	GAT 6K-4	750,-	68	1		●	●	●	●	●						
0,2	30	294×225	GAB 30K0.2N	295,-	64	1		●										
0,2	36	340×240	FKB 36K0.2	510,-	65	1		●										
0,2	65	340×240	FKB 65K0.2	550,-	65	1		●										
0,2	65	340×240	FKT 65K0.2L	890,-	66	1		●	●	●	●	●						
0,5	6	252×228	FCB 6K0.5	195,-	62	1		●										
0,5	15	340×240	FKB 15K0.5A	290,-	63	1		●										
0,5	15	300×225	GAT 10K-4	750,-	68	1		●	●	●	●	●						
0,5	30	340×240	FKT 30K0.5L	790,-	66	1		●	●	●	●	●						
0,5	65	340×240	FKB 65K0.5	510,-	65	1		●										
1	3	252×228	FCE 3K1N	110,-	60	1		●										
1	6	340×240	FKT 6K1LM	890,-	66	1	○	●	●	●	●	●						
1	12	252×228	FCB 12K1	185,-	62	1		●										
1	15	340×240	FKB 15K1A	260,-	63	1		●										
1	30	253×228	FCF 30K-3	185,-	61	1		●										
1	30	253×227	FCB 30K1	220,-	62	1		●										
1	30	340×240	FKB 30K1A	300,-	63	1		●										
1	30	300×225	GAT 30K-3	750,-	68	1		●	●	●	●	●						
1	60	340×240	FKT 60K1L	790,-	66	1		●	●	●	●	●						
1	65	340×240	FKB 65K1A	320,-	63	1		●										
1 2	3 6	295×225	GAB 6K1DNM	225,-	64	1	○	●										
2	6	252×228	FCE 6K2N	110,-	60	1		●										
2	12	340×240	FKT 12K2LM	890,-	66	1	○	●	●	●	●	●						
2	24	252×228	FCB 24K2	185,-	62	1		●										
2 5	6 15	294×225	GAB 15K2DNM	225,-	64	1	○	●										
5	10	320×260	ECE 10K-3N	95,-	59	1		●										
5	10	320×260	ECB 10K-3N	115,-	59	1		●										
5	15	252×228	FCE 15K5N	110,-	60	1		●										
5	30	340×240	FKT 30K5LM	890,-	66	1	○	●	●	●	●	●						
5 10	15 30	294×225	GAB 30K5DNM	225,-	64	1	○	●										
10	20	320×260	ECE 20K-2N	95,-	59	1		●										
10	20	320×260	ECB 20K-2N	115,-	59	1		●										
10	30	252×228	FCE 30K10N	110,-	60	1		●										
10	60	340×240	FKT 60K10LM	890,-	66	1	○	●	●	●	●	●						
20	50	320×260	ECE 50K-2N	95,-	59	1		●										
20	50	320×260	ECB 50K-2N	115,-	59	1		●										

● = standard ○ = option



Plain, mobile, uncomplicated

07

Features

- **High mobility:** Battery operation, compact, lightweight construction, recessed grips on the underside and low weight make this balance ideal for use in several locations
- Particularly large weighing plate
- **Very fast display:** steady weight values within 2 s
- **Simple and convenient 2-key operation**

Technical data

- KERN ECB-N: Large backlit LCD display, digit height 21 mm
- KERN ECE-N: Large LCD display, digit height 21 mm
- Dimensions weighing surface W×D 320×260 mm
- Weighing plate material
 - KERN ECE-N: plastic
 - KERN ECB-N: stainless steel, see larger picture
- Overall dimensions W×D×H 320×300×60 mm
- Optional battery operation, 6×1.5 V AA, standard, operating time up to 100 h, AUTO-OFF function to preserve the battery
- Net weight
 - KERN ECE-N: approx. 1,6 kg
 - KERN ECB-N: approx. 2,6 kg
- Permissible ambient temperature 5 °C/35 °C

Accessories

- **Rechargeable battery pack internal,** operating time up to 30 h without backlight, charging time approx. 10 h, KERN PCB-A01, **€ 75,-**
- **Rechargeable battery pack external,** operating time up to 30 h without backlight, charging time approx. 10 h, KERN KS-A01, **€ 160,-**
- **Tare pan made of stainless steel,** ideal for weighing loose small parts, fruit, vegetables etc., W×D×H 370×240×20 mm, KERN RFS-A02, **€ 55,-**
- **External universal mains adapter,** with universal input and optional input socket adapters for EU, GB, USA, KERN YKA-03, **€ 31,-**
- Further details, plenty of further accessories and suitable printers see *Accessories*

STANDARD



OPTION

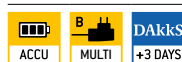

Model	Weighing capacity [Max] kg	Readability [d] g	Reproducibility g	Linearity g	Price excl. of VAT ex works €	Option DAKkS Calibr. Certificate	
						DAKkS KERN	€
KERN							
ECE 10K-3N	10	5	5	± 20	95,- ↓	963-128	88,-
ECE 20K-2N	20	10	10	± 40	95,- ↓	963-128	88,-
ECE 50K-2N	50	20	20	± 80	95,- ↓	963-128	88,-
ECB 10K-3N	10	5	5	± 20	115,- ↓	963-128	88,-
ECB 20K-2N	20	10	10	± 40	115,- ↓	963-128	88,-
ECB 50K-2N	50	20	20	± 80	115,- ↓	963-128	88,-

↓ Price reduction



07

Entry-level bench scale – mobile, practical, lightweight

Features

- **Simple and convenient 2-key operation**
- **Very fast display:** steady weight values within 3 s
- **1** Ideal as a compact letter and parcel scale, especially where space is limited
- **2** Ideal as a grading, commissioning or simple checkweighing scale in production or dispatch
- **Protective working cover** included with delivery

Technical data

- Large LCD display, digit height 25 mm
- Dimensions weighing surface, plastic, WxD 252x228 mm
- Overall dimensions WxDxH 270x323x110 mm
- Optional battery operation, 9 V block not included, operating time up to 12 h, AUTO-OFF function to preserve the battery
- Net weight approx. 2,4 kg
- Permissible ambient temperature 5 °C/35 °C

Accessories

- **Protective working cover**, scope of delivery: 5 items, KERN FCB-A02S05, € 40,-
- **Stainless steel weighing plate**, robust, removable, for easy cleaning, KERN FCE-A01, € 35,-
- **Rechargeable battery pack internal**, operating time up to 20 h without backlight, charging time approx. 10 h, KERN FCB-A01, € 50,-

STANDARD

CAL EXT BATT MULTI DMS 1 DAY

OPTION

ACCU DAKKS +3 DAYS

Model	Weighing capacity [Max] kg	Readability [d] g	Reproducibility g	Linearity g	Price excl. of VAT ex works €	Option	
						DAkKS KERN	DAkKS Calibr. Certificate €
FCE 3K1N	3	1	2	± 3	110,-	963-127	72,-
FCE 6K2N	6	2	2	± 4	110,-	963-128	88,-
FCE 15K5N	15	5	10	± 15	110,-	963-128	88,-
FCE 30K10N	30	10	10	± 30	110,-	963-128	88,-



Compact bench scale with multi-purpose functionality and a high level of accuracy for use in industry and gastronomy

Features

- **Simple and convenient 5-key operation**
- **Very fast display:** steady weight values within 3 s
- Ideal as a
 - compact letter and parcel scale, especially in constricted spaces
 - grading or commissioning balance or simple checkweigher in production or dispatch
 - Checkweigher in the catering trade, cafeterias, school kitchens
- **High mobility:** thanks to battery operation/rechargeable battery operation (optional), compact, lightweight construction, it is suitable for the use in several locations (production, warehouse, dispatch department etc.)
- **Protective working cover** included with delivery

Technical data

- Large backlit LCD display, digit height 25 mm
- Dimensions weighing surface, stainless steel, WxD 253x228 mm
- Overall dimensions WxDxH 270x345x106 mm
- Optional battery operation, 9 V block not included, operating time up to 20 h, AUTO-OFF function to preserve the battery
- Net weight approx. 2,8 kg
- Permissible ambient temperature 5 °C/35 °C

Accessories

- **Protective working cover**, scope of delivery: 5 items, KERN FCF-A01S05, € 40,-
- **Rechargeable battery pack internal**, operating time up to 120 h without backlight, charging time approx. 16 h, KERN GAB-A04, € 40,-

STANDARD



OPTION

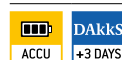

Model	Weighing capacity [Max] kg	Readability [d] g	Reproducibility g	Linearity g	Smallest part weight [Normal] g/piece	Price excl. of VAT ex works €	Option	
							DAkkS KERN	DAkkS Calibr. Certificate €
KERN FCF 3K-4	3	0,1	0,1	± 0,3	2	185,-	963-127	72,-
KERN FCF 30K-3	30	1	1	± 3	20	185,-	963-128	88,-



07

Bench scale with second display on the backside of the scale

Features

- **1 Second display** on the rear of the balance
- **PRE-TARE function** for manual subtraction of a known container weight, useful for checking fill-levels
- **High mobility:** thanks to battery operation/ rechargeable battery operation (optional), compact, lightweight construction, it is suitable for the use in several locations (production, warehouse, dispatch department etc.)
- **Data interface RS-232** standard
- **Protective working cover** included with delivery

Technical data

- Backlit LCD display, digit height 25 mm
- Dimensions weighing surface, stainless steel, WxD 253x229 mm
- Overall dimensions WxDxH 270x323x110 mm
- Optional battery operation, 9 V block not included, operating time up to 12 h
- Net weight approx. 2,6 kg
- Permissible ambient temperature 5 °C/35 °C

Accessories

- **Protective working cover**, scope of delivery: 5 items, KERN FCB-A02S05, **€ 40,-**
- **Rechargeable battery pack internal**, operating time up to 10 h without backlight, charging time approx. 10 h, KERN FCB-A01, **€ 50,-**
- Further details, plenty of further accessories and suitable printers see *Accessories*

STANDARD OPTION

CAL EXT	RS 232	PCS	RECIPE	PERCENT	UNIT	MOVE	BATT	MULTI	DMS	1 DAY	ACCU	DAkkS +3 DAYS

Model	Weighing capacity [Max] kg	Readability [d] g	Reproducibility g	Linearity g	Smallest part weight [Normal] g/piece	Price excl. of VAT ex works €	Option	
							DAkkS KERN	€
FCB 3K0.1	3	0,1	0,1	± 0,3	2	215,-	963-127	72,-
FCB 8K0.1	8	0,1	0,1	± 0,3	2	240,-	963-128	88,-
FCB 6K0.5	6	0,5	0,5	± 1,5	10	195,-	963-128	88,-
FCB 12K1	12	1	1	± 3	20	185,-	963-128	88,-
FCB 30K1	30	1	1	± 3	20	220,-	963-128	88,-
FCB 24K2	24	2	2	± 6	40	185,-	963-128	88,-



Bench scale up to 65 kg with large weighing plate

07

Features

- **PRE-TARE function** for manual subtraction of a known container weight, useful for checking fill-levels
- **Particularly practical:** thanks to the large weighing capacities and compact dimensions, you can accurately weigh heavy loads in the most restricted of spaces. Useful for determining very small weight differences, such as, for example, gas wastage, abrasion of mechanical parts, rock samples, minerals, druses, silver etc.
- **Freely programmable weighing unit**, e.g. display direct in special units such as length of wire g/m, surface weight g/m², or else
- **Protective working cover** included with delivery

Technical data

- Large backlit LCD display, digit height 25 mm
- Dimensions weighing surface, stainless steel, W×D 340×240 mm
- Overall dimensions W×D×H 350×390×120 mm
- Optional battery operation, 9 V block not included, operating time up to 12 h
- Net weight approx. 6 kg
- Permissible ambient temperature 5 °C/35 °C

Accessories

- **Protective working cover**, scope of delivery: 5 items, KERN FKB-A02S05, € 40,-
- **Rechargeable battery pack internal**, operating time up to 10 h without backlight, charging time approx. 10 h, KERN PCB-A01, € 75,-
- Further details, plenty of further accessories and suitable printers see *Accessories*

STANDARD



OPTION



Model	Weighing capacity [Max] kg	Readability [d] g	Reproducibility g	Linearity g	Smallest part weight [Normal] g/piece	Price excl. of VAT ex works €	Option	
							DAkks KERN	DAkks Calibr. Certificate €
FKB 8K0.1A	8	0,1	0,1	± 0,3	2	300,-	963-128	88,-
FKB 15K0.5A	15	0,5	0,5	± 1,5	10	290,-	963-128	88,-
FKB 15K1A	15	1	1	± 3	20	260,-	963-128	88,-
FKB 30K1A	30	1	1	± 3	20	300,-	963-128	88,-
FKB 65K1A	65	1	1	± 3	20	320,-	963-129	105,-



07

Checkweighing and portioning scale, also with EC type approval [M]

Features

- **Compact size**, practical for small spaces
- **High mobility**: thanks to rechargeable battery operation (optional), compact, lightweight construction, it is suitable for the use in several locations (production, warehouse, dispatch department etc.)
- **Weighing with tolerance range (checkweighing)**: a visual and audible signal helps with portioning, dispensing or grading
- **Totalising** of weights
- **Protective working cover** included with delivery

Technical data

- Large backlit LCD display, digit height 24 mm
- Dimensions weighing surface WxD 294x225 mm
- Overall dimensions WxDxH 320x330x125 mm
- Net weight approx. 3,0 kg
- Permissible ambient temperature
GAB-N: 0 °C/40 °C
GAB-DNM: -10 °C/40 °C

Accessories

- **Protective working cover**, scope of delivery: 5 items, KERN CFS-A02S05, € 40,-
- **Rechargeable battery pack internal**, operating time up to 90 h without backlight, charging time approx. 12 h, KERN GAB-A04, € 40,-

- **WiFi interface** for wireless connection of the balance to networks and WiFi capable devices, such as tablets, laptops or smartphones, must be ordered at purchase, please ask for delivery time, KERN CFS-A05, € 120,-
- **Signal lamp** for visual support of weighing with tolerance range, KERN CFS-A03, € 250,-
- **Y-cable** for parallel connection of two terminal devices to the RS-232 interface on the scale, e.g. signal lamp or barcode reader and printer, KERN CFS-A04, € 35,-
- **Tare pan made of stainless steel**, ideal for weighing loose small parts, fruit, vegetables etc., WxDxH 370x240x20 mm, KERN RFS-A02, € 55,-
- Further details, plenty of further accessories and suitable printers see *Accessories*

Application examples

- Small industrial scale for pharmacies
- Hand mixtures of tea, coffee, chocolates
- Portioning of dough, meat, fish, poultry, mixed salads in cafeterias etc.
- Mobile weighing of freshly picked fruit on site
- Checkweigher in supermarkets
- High-precision industrial applications, piece counting or stock-taking

Note: Official verification duty for commercial trade

STANDARD



OPTION

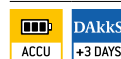

FACTORY



Model	Weighing capacity [Max] kg	Readability [d] g	Verification value [e] g	Minimal load [Min] g	Smallest part weight [Normal] g/piece	Price excl. of VAT ex works €	Option				
							Verification	€	DAkkS	Certificate	
KERN											
GAB 6K0.05N	6	0,05	-	-	0,5	295,-	-	-	963-128	88,-	
GAB 12K0.1N	12	0,1	-	-	1	295,-	-	-	963-128	88,-	
GAB 30K0.2N	30	0,2	-	-	2	295,-	-	-	963-128	88,-	
Dual-range balance switches automatically to the next largest weighing capacity [Max] and readability [d]											
Note: For applications that require verification, please order verification at the same time, initial verification at a later date is not possible.											
Verification at the factory, we need to know the full address of the location of use.											
GAB 6K1DNM	3 6	1 2	1 2	20	2	225,-	965-228	70,-	963-128	88,-	
GAB 15K2DNM	6 15	2 5	2 5	40	5	225,-	965-228	70,-	963-128	88,-	
GAB 30K5DNM	15 30	5 10	5 10	100	10	225,-	965-228	70,-	963-128	88,-	

Price reduction



Large, high resolution bench scale

Features

- Thanks to the high resolution of up to 360.000 points it is ideal for high-precision weighing in the industrial field
- **Housing with robust aluminium diecast housing trough**, maintains the stability, protects the weighing technology elements and is robust enough to cope with everyday use
- **Particularly practical:** thanks to the large weighing capacities and compact dimensions, you can accurately weigh heavy loads in the most restricted of spaces. Useful for determining very small weight differences, such as, for example, gas wastage, abrasion of mechanical parts, rock samples, minerals, druses, silver etc.
- **PRE-TARE function** for manual subtraction of a known container weight, useful for checking fill-levels

- **Freely programmable weighing unit**, e.g. display direct in special units such as length of wire g/m, surface weight g/m², or else
- **Protective working cover** included with delivery

Technical data

- Backlit LCD display, digit height 18 mm
- Dimensions weighing surface, stainless steel, WxD 340x240 mm
- Dimensions housing WxDxH, 350x390x120 mm
- Optional battery operation, 6x1.5 V Size C not included, operating time up to 40 h
- Net weight approx. 7 kg
- Permissible ambient temperature 10 °C/40 °C

Accessories

- **Protective working cover**, scope of delivery: 5 items, KERN FKB-A02S05, **€ 40,-**
- **Rechargeable battery pack external**, operating time up to 30 h without backlight, charging time approx. 10 h, KERN KS-A01, **€ 160,-**
- **Tare pan made of stainless steel**, ideal for weighing loose small parts, fruit, vegetables etc., WxDxH 370x240x20 mm, KERN RFS-A02, **€ 55,-**
- Further details, plenty of further accessories and suitable printers see *Accessories*

STANDARD



OPTION



Model	Weighing capacity [Max] kg	Readability [d] g	Reproducibility g	Linearity g	Smallest part weight [Normal] g/piece	Price excl. of VAT ex works €	Option	
							DAKKS KERN	DAKKS Calibr. Certificate €
FKB 6K0.02	6	0,02	0,04	± 0,1	0,2	520,-	963-128	88,-
FKB 8K0.05	8	0,05	0,05	± 0,15	0,5	480,-	963-128	88,-
FKB 16K0.05	16	0,05	0,1	± 0,25	0,5	580,-	963-128	88,-
FKB 16K0.1	16	0,1	0,1	± 0,3	1	480,-	963-128	88,-
FKB 36K0.1	36	0,1	0,2	± 0,5	1	550,-	963-128	88,-
FKB 36K0.2	36	0,2	0,2	± 0,6	2	510,-	963-128	88,-
FKB 65K0.2	65	0,2	0,4	± 1	2	550,-	963-129	105,-
FKB 65K0.5	65	0,5	0,5	± 1,5	5	510,-	963-129	105,-



Alibi memory

- Ring memory for up to 49,152 measuring results (744 measuring results per day!)
- Saved measuring results cannot be changed or cleared. If the maximum memory capacity is reached, then the oldest value will be overwritten
- In addition to the measuring result, the date, time, tare value, a sequential number and the serial number of the balance are also saved
- Saved measuring results can be searched and recalled easily
- The alibi memory can also be used for applications which do not require verification
- Complies with WELMEC 2.5

Touchscreen industrial scale with enormous range of functions, also with EC type approval [M]



Easy input of text and values
Using large keypad, e.g. up to 80 item descriptions, user name, packaging weights for tare containers etc.



80 memories for each mode
e.g. for Checkweighing, PRE-TARE, reference weight, target value when dispensing, item descriptions, user name, weights for tare containers, etc. Easy to enter using the large-scale keypad



Weighing with tolerance range (checkweighing)
Input of an upper/lower limit value. A visual and audible signal assists with portioning, dispensing or grading

Features

- **Convenient recipe weighing:** 99 In recipes with 10 components each can be stored in plain text. There is a function to adjust the other components if the initial weight was too high. The actual values and the desired values well as the proportionate percentages can be printed afterwards.
- **Multiplier function:** recipes with the ingredient weights recorded as percentage values can easily be replicated by entering a new target weight. The ideal solution for the preparation of larger containers, bulk packs etc.
- **Rapid function** for shortened stabilisation time with reduced readability
- **16 print forms** which can store up to 20 different information, such as, e.g., date, time, operator, item, net, tare, gross, PCS, target weight, PRE-TARE etc. The print forms can be generated easily in an Excel list at the PC and transferred to the balance using the RS-232 interface
- **Control outputs (optocoupler, digital I/O)** to connect relays, signal lamps, valves etc. (35 V/80 mA)
- **Protective working cover and hook for underfloor weighing** standard

Technical data

- Large backlit LCD touch display, digit height 18 mm, screen diagonal 5,8" (127×74 mm)
- Dimensions weighing surface, stainless steel, W×D 340×240 mm
- Overall dimensions W×D×H 350×390×120 mm
- Optional battery operation, 6×1.5 V Size C not included, operating time up to 20 h
- Permissible ambient temperature 10 °C/40 °C

Accessories

- **Protective working cover**, scope of delivery: 5 items, KERN FKB-A02S05, **€ 40,-**
- **Rechargeable battery pack external**, operating time up to 20 h without backlight, charging time approx. 10 h, KERN KS-A01, **€ 160,-**
- **RS-232/Ethernet adapter** for connection to an IP-based Ethernet network, KERN YKI-01, **€ 290,-**
- **RS-232/USB adapter**, to connect peripheral devices with USB connection, KERN AFH 12, **€ 85,-**
- **Signal lamp** for visual support of weighing with tolerance range, KERN IKT-A04, **€ 260,-**
- Further details, plenty of further accessories and suitable printers see *Accessories*

Modes

- ① Weighing
- ② Counting
- ③ Dispensing
- ④ Recipe weighing
- ⑤ Checkweighing
- ⑥ Totalising with daily total
- ⑦ Percentage determination
- ⑧ Animal weighing
- ⑨ Surface weight
- ⑩ Density determination **B**, not for [M]
- ⑪ Rapid function, not for [M]

Functions

- Capacity display with ①-②, ⑤-⑦, ⑨-⑪
- Dispensing aid (-/+), with ③, ④
- Net/gross display, permanent, with ①, ③-⑤, ⑧-⑪
- Variable reference quantity, with ②
- Automatic reference optimisation, with ②
- PRE-TARE numerical or from the memory unit, with ①-⑦, ⑪
- Entering of item or batch description, operator etc., with ①-⑦, ⑪
- Freely programmable weighing unit, e.g. display direct in special units such as length of thread g/m, grammage g/m², or similar, with ⑨
- Date/time, with ①-⑪
- Statistical function, with ①
- GLP printout, with ①-⑪
- Individual formatting of up to 16 printer forms, recipes, operating mode master data in MS Excel, import via RS-232, for examples, see the internet, with ①-⑪

STANDARD

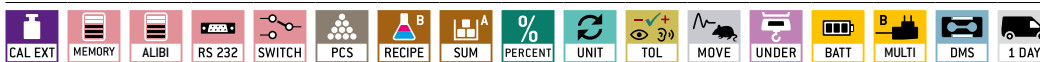

OPTION



FACTORY



Model	Weighing capacity [Max] kg	Readability [d] g	Verification value [e] g	Minimal load [Min] g	Smallest part weight [Normal] g/piece	Price excl. of VAT ex works €	Option				
							Verification	€	DAkKS Calibr. KERN	Certificate €	
KERN											
FKT 30K0.5L	30	0,5	-	-	5	790,-	-	-	963-128	88,-	
FKT 60K 1L	60	1	-	-	10	790,-	-	-	963-129	105,-	
High resolution readability											
FKT 6K0.02L	6	0,02	-	-	0,2	890,-	-	-	963-128	88,-	
FKT 16K0.05L	16	0,05	-	-	0,5	890,-	-	-	963-128	88,-	
FKT 36K0.1L	36	0,1	-	-	1	890,-	-	-	963-128	88,-	
FKT 65K0.2L	65	0,2	-	-	2	890,-	-	-	963-129	105,-	
Note: For applications that require verification, please order verification at the same time, initial verification at a later date is not possible. Verification at the factory, we need to know the full address of the location of use.											
FKT 6K1LM	6	1	1	20	10	890,-	965-228	70,-	963-128	88,-	
FKT 12K2LM	12	2	2	40	20	890,-	965-228	70,-	963-128	88,-	
FKT 30K5LM	30	5	5	100	50	890,-	965-228	70,-	963-128	88,-	
FKT 60K10LM	60	10	10	200	100	890,-	965-229	93,-	963-129	105,-	

Price reduction



07

KERN **easytouch** bench scale – the intuitive way to weigh

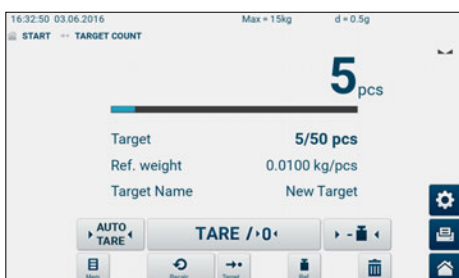

Convenient piece-counting function
Komfortable Stückzahl-Funktion

Standard use: Direct input of the reference quantity or the reference weight
Professional use: Recall of items to be counted from the database with all relevant additional data such as piece weight, name, reference quantity, tare container weight, tolerances. Which means a super-fast sequence when counting: select item – load – count – done!

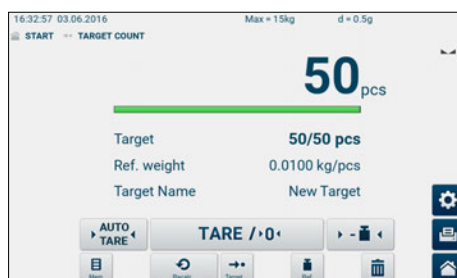

Fill-to-target function

Programmable target quantity or target weight. A signal will be displayed when the target value is reached



Convenient weighing with tolerance range (Checkweighing)

Standard use: Direct input of the tolerances in grams or percent
Professional use: Recall of items from the database with all relevant additional data such as piece weight, name, reference quantity, tare container weight, tolerances. That leads to a super-fast sequence when portioning, dosing or sorting: Select item – load – check – done!



Features

- High-quality, rapid processors allow efficient, delay-free operation
- Thanks to the **intuitive touchscreen concept** and multi-lingual operation (DE, GB, FR, IT, ES, PT, NL, FI, PL, RUS, SE, CZ) the balance can be used easily by inexperienced users, straightaway. For the professional user, the balance provides convenient functions which permit a high level of individualisation and which thereby make operation significantly easier and quicker.
- Through a **large memory (256 MB)**, e.g. for item master data, weighing data etc. the balance is the ideal solution when working with a large range of goods or where there are high requirements for record keeping and documentation
- **1** Thanks to the high level of **connectivity** it is easy to connect USB sticks for data storage or data transfer to PCs, scales and networks using RS-232 or USB. This means that this range can be used for many different functions in Industry 4.0 applications
- **Convenient recipe weighing**
 Standard use: Direct input of the recipe ingredients in grams or percent
 Professional use: Recall of items from the database with all relevant additional data such as target value, tolerances, name, tare container weight. That leads to a super-fast sequence when recipe-weighing: select recipe – weigh – done!
 A graphic signal helps when dosing individual recipe ingredients. An information column on the lefthand edge of the screen allows you to see at a glance which ingredients have already been weighed (proportionately).

Recipes can be easily transferred via USB stick between the KERN touchscreen scales GAT or IFT

- **Take-Off function:** allows you to remove the same quantity every time, e.g. when portioning in cafeterias or when picking small parts. A colour bar graph shows whether the quantity removed is below the limit or within the specified tolerances (blue) or is above the limit (red)
- **Classifying:** Similar objects are automatically classified according to their weight into predetermined classes.
- **AUTO-PRINT function:** Automatic printing of the weighing when the weighing value remains unchanged. The print function as well as the content of the print-out can be adjusted individually depending on the operating mode
- **Searching and remote control of the balance** using external control devices or computers with the KERN Communication Protocol (KCP). KCP is a standardised interface command structure for KERN balances and other instruments which allows you to recall and manage all relevant parameters and device functions. You can therefore simply connect KERN devices with KCP to computers, industrial control systems and other digital systems. In a large number of cases the KCP is compatible with the MT-SICS protocol. Only possible through data interface RS-232, other interfaces on request
- **2** The battery compartment of the device can be opened easily, which means it is possible to change the batteries without having to use any tools or break any verification seal labels etc.

Technical data

- Large backlit LCD touch display, digit height 12 mm, screen diagonal 7" (155x85 mm)
- Dimensions weighing surface, stainless steel, WxD 300x225 mm
- Overall dimensions WxDxH 315x350x120 mm

Accessories

- **Rechargeable battery pack internal**, operating time up to 40 h with backlight, charging time approx. 12 h, KERN GAB-A04, **€ 40,-**
- **Y-cable** for parallel connection of two terminal devices to the RS-232 interface on the scale, e.g. signal lamp or barcode reader and printer, KERN CFS-A04, **€ 35,-**
- **Software** for rapid and easy processing of the database at the PC (exporting, processing, importing), KERN SET-1.0, **€ 150,-**
- Further details, plenty of further accessories and suitable printers see *Accessories*

STANDARD

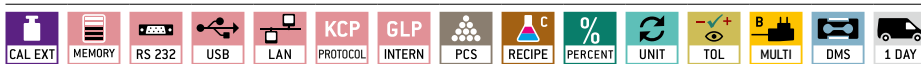

OPTION



Model	Weighing capacity [Max] kg	Readability [d] g	Reproducibility g	Linearity g	Smallest part weight [Normal] g/piece	Price excl. of VAT ex works €	Option	
							DAkKS KERN	Calibr. Certificate €
KERN GAT 6K-4	6	0,2	0,4	± 0,6	2	750,-	963-128	88,-
KERN GAT 10K-4	15	0,5	0,5	± 1,5	5	750,-	963-128	88,-
KERN GAT 30K-3	30	1	2	± 3	10	750,-	963-128	88,-

Price reduction

Stainless steel/Protection against dust and water splashes IP65...68

KERN scales – not scared of water at all!

Scales used in industrial situations or the food industry are often exposed to extreme stresses and strains. Water, oils, fats, varnish, dust, dirt, flour, small parts, etc. are all natural enemies of a scale. In industries such as the chemical, pharmaceutical, food, manufacturing industries, etc. scales must be able to cope with these stresses without this affecting their performance.





For use in such harsh environmental conditions, levels of protection are defined, which specify which environmental stresses a system can be exposed to with respect to the level of contact, foreign object and moisture protection, without damage being caused to the unit. These levels of protection are described in the following standard: “DIN EN 60529: protection types through housing” The IP code usually consists of a two-digit combination, which gives the relevant level of protection, e.g. IP68.

The first digit specifies the protection level for contact protection and protection against foreign bodies (dust protection), the second digit is for the water and moisture protection (protection against splashes of water).

All stainless steel components of the IP65...68 protected KERN stainless steel scales are made of corrosion-resistant steel of quality class 1.4301 (DIN X5CrNi18-10). The material properties support you in your ► **HACCP**-compliant quality system.

► See the glossary on page 206–208

Extract from the standard: “DIN EN 60529: protection types through housing”:

KERN-Pictogram	1. digit	Specification	2. digit	Specification
	6	Dustproof	5	Protection against jets of water (nozzle) from any angle (cleaning with a damp cloth)
	6	Dustproof	6	Protection against powerful jets of water
	6	Dustproof	7	Protection against temporary immersion
	6	Dustproof	8	Protection against continuous immersion (designed for continuous use in wet areas, submersion is possible depending on the pressure (water depth))



Lisa Haiß

Product specialist Stainless steel scales

Tel. +49 7433 9933-219

Fax +49 7433 9933-29219

lisa.haiss@kern-sohn.com

HIGHLIGHT











from €

175,-

- Now with innovative checkweighing display
- Now also with EC-Type Approval [M]
- High mobility: thanks to compact, flat construction and low weight, it is suitable for use in several locations (kitchen, cafeteria, warehouse etc.)

Quick-Finder Stainless steel/Protection against dust and water splashes IP65...68

Readability [d] g	Weighing capacity [Max] kg	Model	Price excl. of VAT ex works €	Page	 DAYS	 M	 CAL EXT	 RS 232	 TOL	 IP	 INOX	 ACCU
					For an explanation on the pictos, see the front flap							
	0,1	0,5	FOB 500-1S	79,-	72	1		●			●	
	0,1	0,5	FOB 0.5K-4NS	105,-	72	1		●			●	
	0,2	1,5	WTB 1K-4N	215,-	75	1		●	●			●
	0,2	1,5	FFN 1K-4N	260,-	77	1		●	●		●	●
	0,2	3	FOB 3K-4NL	265,-	74	1		●	●		●	
	0,5	1,5	FOB 1.5K0.5	180,-	73	1		●	●		●	●
	0,5	1,5	FOB 1K-4LM	265,-	73	1	○	●		●	●	●
	0,5	1,5	WTB 1K-4NM	250,-	75	1	○	●		●	●	●
	0,5	1,5	FFN 1K-4NM	285,-	77	1	○	●		●	●	●
	0,5	3	WTB 3K-4N	215,-	75	1		●	●		●	●
	0,5	3	FFN 3K0.5IPN	255,-	77	1	○	●		●	●	●
	0,5	3	FXN 3K-4N	280,-	77	1	○	●		●	●	
0,5 1		5 7,5	FOB 7K-4NL	230,-	74	1		●		●	●	
	1	3	FOB 3K1	180,-	73	1		●		●	●	●
	1	3	FOB 3K-3LM	265,-	73	1	○	●		●	●	●
	1	3	WTB 3K-3NM	250,-	75	1	○	●		●	●	●
	1	3	FFN 3K1IPM	285,-	77	1	○	●		●	●	●
	1	3	FXN 3K-3M	340,-	77	1	○	●		●	●	●
	1	5	FOB 5K1S	79,-	72	1		●			●	
	1	5	FOB 5K-3NS	105,-	72	1		●			●	
	1	6	WTB 6K-3N	215,-	75	1		●	●			●
	1	6	FFN 6K1IPN	255,-	77	1		●	●		●	●
	1	6	FXN 6K-3N	280,-	77	1	○	●		●	●	
	1	10	SFB 10K1HIP	670,-	78	1		●	●		●	●
1 2		3 6	SXS 6K-3M	670,-	79	1	○	●		●	●	●
1 2		8 15	FOB 10K-3NL	230,-	74	1		●		●	●	●
	2	6	FOB 6K2	180,-	73	1		●		●	●	●
	2	6	WTB 6K-3NM	250,-	75	1	○	●		●	●	●
	2	6	FFN 6K2IPM	285,-	77	1	○	●		●	●	●
	2	6	FXN 6K-3M	340,-	77	1	○	●		●	●	
	2	15	WTB 10K-3N	215,-	75	1		●	●			●
	2	15	FFN 15K2IPN	255,-	77	1	○	●		●	●	●
	2	15	FXN 10K-3N	280,-	77	1	○	●		●	●	
	2	20	SFB 20K2HIP	670,-	78	1		●	●		●	●
2 5		6 15	SXS 10K-3M	670,-	79	1	○	●		●	●	●
2 5		6 15	SXS 10K-3LM	820,-	79	1	○	●		●	●	●
2 5		16 30	FOB 30K-3NL	230,-	74	1		●		●	●	●
	5	15	FOB 10K-3LM	265,-	73	1	○	●		●	●	●
	5	15	WTB 10K-3NM	250,-	75	1	○	●		●	●	●
	5	15	FFN 15K5IPM	285,-	77	1	○	●		●	●	●
	5	15	FXN 10K-3M	340,-	77	1	○	●		●	●	
	5	15	SFB 15K5HIPM	690,-	78	1	○	●		●	●	●
	5	25	FFN 25K5IPN	255,-	77	1		●	●		●	●
	5	30	WTB 30K-3N	215,-	75	1		●	●			●
	5	30	FXN 30K-3N	280,-	77	1	○	●		●	●	
	5	50	SFB 50K5HIP	670,-	78	1		●	●		●	●
	5	50	SFB 50K5LHIP	740,-	78	1		●	●		●	●
	5	50	SFB 50K-3XL	870,-	78	1		●	●		●	●
5 10		15 30	SXS 30K-2M	820,-	79	1	○	●		●	●	●
5 10		15 30	SXS 30K-2LM	1110,-	79	1	○	●		●	●	●
	10	25	FFN 25K10IPM	285,-	77	1	○	●		●	●	●
	10	30	WTB 30K-2NM	250,-	75	1	○	●		●	●	●
	10	30	FXN 30K-2M	340,-	77	1	○	●		●	●	
	10	30	SFB 30K10HIPM	690,-	78	1	○	●		●	●	●
	10	100	SFB 100K10HIP	730,-	78	1		●	●		●	●
	10	100	SFB 100K-2XL	1140,-	78	1		●	●		●	●
10 20		30 60	SXS 60K-2M	820,-	79	1	○	●		●	●	●
10 20		30 60	SXS 60K-2LM	1110,-	79	1	○	●		●	●	●
	20	60	SFB 60K-2XLM	1010,-	78	1	○	●		●	●	●
20 50		60 150	SXS 100K-2M	1110,-	79	1	○	●		●	●	●
20 50		60 150	SXS 100K-2LM	1370,-	79	1	○	●		●	●	●
	50	150	SFB 100K-2HM	760,-	78	1	○	●		●	●	●
	50	150	SFB 100K-2XLM	1150,-	78	1	○	●		●	●	●
50 100		150 300	SXS 300K-2M	1370,-	79	1	○	●		●	●	●

News 2019

● = standard ○ = option



KERN FOB-S



KERN FOB-NS

Compact stainless steel balances with high level of protection against dust and water splashes

	KERN FOB-S	KERN FOB-NS
Features	<ul style="list-style-type: none"> • Stainless steel design of the housing and weighing plate. Its smooth surfaces make it simple to clean • High mobility: thanks to battery operation, compact, lightweight construction, it is suitable for the use in several locations (kitchen, sales office, cafeteria, Food industry-Laboratory etc.) • Secure and non-slip positioning with rubber feet • Protective working cover included with delivery 	
	<ul style="list-style-type: none"> • Your support in a HACCP-compliant quality system 	<ul style="list-style-type: none"> • Particularly flat design • Protection against dust and water splashes IP65 (only when using battery)
Technical data	<ul style="list-style-type: none"> • Large LCD display, digit height 20 mm • Dimensions weighing surface, stainless steel, WxD 125x155 mm • Overall dimensions WxDxH 175x155x40 mm • Ready for use: Battery included, 9 V Block, operating time up to 20 h • Net weight approx. 0,7 kg • Permissible ambient temperature 10 °C/40 °C 	<ul style="list-style-type: none"> • Large LCD display, digit height 20 mm • Dimensions weighing surface, stainless steel, WxD 120x150 mm • Overall dimensions WxDxH 170x150x40 mm • Ready for use: Batteries included, 9 V block, operating time up to 24 hours • Net weight approx. 0,8 kg • Permissible ambient temperature 10 °C/35 °C
Accessories	<ul style="list-style-type: none"> • Protective working cover, scope of delivery: 5 items, KERN FOB-A11S05, € 40,- • Mains adapter external, KERN FOB-A09, € 35,- 	<ul style="list-style-type: none"> • Protective working cover, scope of delivery: 5 items, KERN FOB-A12S05, € 40,- • Mains adapter external, KERN FOB-A09, € 35,-

STANDARD FOB-S



OPTION



STANDARD FOB-NS



OPTION



Model	Weighing capacity [Max] kg	Readability [d] g	Weighing plate WxD mm	Price excl. of VAT ex works €	Options	
					DAkkS Calibr. Certificate DKD KERN	€
KERN						
FOB 500-1S	0,5	0,1	155x125	79,-	963-127	72,-
FOB 5K1S	5	1	155x125	79,-	963-127	72,-
FOB 0.5K-4NS	0,5	0,1	150x120	105,-	963-127	72,-
FOB 5K-3NS	5	1	150x120	105,-	963-127	72,-



Stainless steel balance with special protection against humidity, also with EC-Type Approval [M]

Features

- **1 NEW: Innovative weighing with tolerance range (Checkweighing):** The colour of the display changes depending on the weight (too light/ok/too heavy) and is an aid to help with portioning, dosing and grading
- **Stainless steel design** of the housing and weighing plate. Its smooth surfaces make it simple to clean
- **High mobility:** thanks to battery operation, compact, lightweight construction, it is suitable for the use in several locations (kitchen, sales office, cafeteria, Food industry-Laboratory etc.)
- Your support in a **HACCP**-compliant quality system
- **Secure and non-slip positioning** with rubber feet
- **Increased protection against humidity** through waterproof silicone sealing of the load cell, electronics and soldering joints

- **Check the weighing capacity which is in use** at the press of a button (net/gross weight)

Technical data

- Large backlit LCD display, digit height 25 mm
- Dimensions weighing surface, Stainless steel
 - A W×D 165×175 mm, see larger picture
 - B W×D 215×215 mm
- Overall dimensions W×D×H
 - A 175×235×62 mm,
 - B 220×305×80 mm
- KERN FOB-LM: Optional battery operation, 4×1.5 V AA, standard, operating time up to 48 h, AUTO-OFF function to preserve the battery
- Net weight
 - A approx. 2,0 kg, B approx. 3,8 kg
- Permissible ambient temperature
 - A KERN FOB: 5 °C/35 °C,
 - B KERN FOB-LM: -10 °C/40 °C

Accessories

- **Protective working cover**, scope of delivery: 5 items, KERN FOB-A13S05, € 40,-
- KERN FOB: **Rechargeable battery pack internal**, operating time up to 24 h without backlight, charging time approx. 8 h, KERN FOB-A07, € 45,-
- **Mains adapter external**, not included, can be reordered, KERN FOB-A01, € 35,-
- **2 Tare pan made of stainless steel**, ideal for weighing loose small parts, fruit, vegetables etc., W×D×H 370×240×20 mm, KERN RFS-A02, € 55,-

STANDARD

CAL EXT TOL INOX BATT 230 V DMS 1 DAY

FOB-LM

OPTION

ACCU DAKKS +3 DAYS

FOB

FACTORY

M +3 DAYS

FOB-LM

Model	Weighing capacity [Max] kg	Readability [d] g	Verification value [e] g	Minimal load [Min] g	Weighing plate	Price excl. of VAT ex works €	Option			
							Verification		DAkKS Calibr. Certificate	
KERN							M KERN	€	DAKKS KERN	€
FOB 1.5K0.5	1,5	0,5	-	-	A	175,-	-	-	963-127	72,-
FOB 3K1	3	1	-	-	A	180,-	-	-	963-127	72,-
FOB 6K2	6	2	-	-	A	175,-	-	-	963-128	88,-
Note: For applications that require verification, please order verification at the same time, initial verification at a later date is not possible.										
Verification at the factory, we need to know the full address of the location of use.										
FOB 1K-4LM	NEW 1,5	0,5	0,5	10	B	265,-	965-227	55,-	963-127	72,-
FOB 3K-3LM	NEW 3	1	1	20	B	265,-	965-227	55,-	963-127	72,-
FOB 10K-3LM	NEW 15	5	5	100	B	265,-	965-228	70,-	963-128	88,-

NEW New model



Stainless steel bench scale with large weighing capacities and IP67 protection against dust and water splashes

Features

- **Stainless steel design** of the housing and weighing plate. Its smooth surfaces make it simple to clean
- Your support in a **HACCP-compliant** quality system
- **High mobility:** thanks to battery operation, compact, lightweight construction, it is suitable for the use in several locations (kitchen, sales office, cafeteria, Food industry-Laboratory etc.)
- **Protection against dust and water splashes IP67** (only when using battery)

Technical data

- Large backlit LCD display, digit height 25 mm, stainless steel
- Overall dimensions W×D×H 285×255×90 mm
- **Ready for use:** Batteries included, 4×1.5 V AA, operating time up to 48 h
- Net weight approx. 3,8 kg
- Permissible ambient temperature 5 °C/35 °C

Accessories

- **Protective working cover**, scope of delivery: 5 items, KERN FOB-A13S05, **€ 40,-**
- **Mains adapter external**, not included, not suitable for model FOB 3K-4NL, KERN FOB-A01, **€ 35,-**
- **Tare pan made of stainless steel**, ideal for weighing loose small parts, fruit, vegetables etc., W×D×H 370×240×20 mm, KERN RFS-A02, **€ 55,-**

STANDARD



OPTION



Model	Weighing capacity [Max] kg	Readability [d] g	Weighing plate W×D mm	Price excl. of VAT ex works €	Option	
					DAkkS KERN	DAkkS Calibr. Certificate €
FOB 3K-4NL <small>NEW</small>	3	0,2	252×200	265,-	963-127	72,-
Dual-range balance switches automatically to the next largest weighing capacity [Max] and readability [d]						
FOB 7K-4NL	5 7,5	0,5 1	252×200	230,-	963-128	88,-
FOB 10K-3NL	8 15	1 2	252×200	230,-	963-128	88,-
FOB 30K-3NL	16 30	2 5	252×200	230,-	963-128	88,-

NEW New model



Ideal for food industry, thanks to its IP65 protection and special checkweighing display, now also with EC type approval [M]

Features

- **Suitable for the ever-increasing hygienic requirements** in the food industry
- Your support in a **HACCP-compliant** quality system
- **1 Protection against dust and water splashes IP65** (only when using rechargeable battery pack)
- **Very fast display:** steady weight values within 2 s
- **2 Second display** on the rear of the balance
- **Compact size**, practical for small spaces
- **3 Innovative weighing with tolerance range (Checkweighing):** The colour of the display changes depending on the weight (too light/ok/too heavy) and is an aid to help with portioning, dosing and grading

- **High mobility:** thanks to rechargeable battery operation (optional), compact, lightweight construction, it is suitable for the use in several locations
- **Recessed grips on the underside** of the scale for easy transportation
- **Protective working cover** included with delivery

Technical data

- Large backlit LCD display, digit height 25 mm
- Weighing plate dimensions, stainless steel, WxD 260x200 mm
- Overall dimensions WxDxH 285x315x128 mm
- Net weight approx. 3,2 kg
- Permissible ambient temperature -10 °C/40 °C

Accessories

- **Protective working cover**, scope of delivery: 5 items, KERN RFB-A01S05, **€ 40,-**
- **Rechargeable battery pack internal**, operating time up to 50 h without backlight, charging time approx. 12 h, KERN WTB-A01N, **€ 35,-**
- **4 Tare pan made of stainless steel**, ideal for weighing loose small parts, fruit, vegetables etc., WxDxH 370x240x20 mm, KERN RFS-A02, **€ 55,-**
- **5 Sturdy transport case** to protect and store the scale, dimensions WxDxH 510x360x220 mm, KERN RFB-A02, **€ 115,-**

STANDARD OPTION FACTORY

CAL EXT UNIT TOL IP 65 MULTI DMS 1 DAY ACCU DAKKS +3 DAYS M +3 DAYS WTB-NM

Model	Weighing capacity [Max] kg	Readability [d] g	Verification value [e] g	Minimal load [Min] g	Price excl. of VAT ex works €	Option			
						Verification		DAkkS Calibr. Certificate	
KERN						M III KERN	€	DAkkS KERN	€
WTB 1K-4N	1,5	0,2	-	-	215,-	-	-	963-127	72,-
WTB 3K-4N	3	0,5	-	-	215,-	-	-	963-127	72,-
WTB 6K-3N	6	1	-	-	215,-	-	-	963-128	88,-
WTB 10K-3N	15	2	-	-	215,-	-	-	963-128	88,-
WTB 30K-3N	30	5	-	-	215,-	-	-	963-128	88,-

Note: For applications that require verification, please order verification at the same time, initial verification at a later date is not possible. Verification at the factory, we need to know the full address of the location of use.

WTB 1K-4NM	1,5	0,5	0,5	10	250,-	965-227	55,-	963-127	72,-
WTB 3K-3NM	3	1	1	20	250,-	965-227	55,-	963-127	72,-
WTB 6K-3NM	6	2	2	40	250,-	965-228	70,-	963-128	88,-
WTB 10K-3NM	15	5	5	100	250,-	965-228	70,-	963-128	88,-
WTB 30K-2NM	30	10	10	200	250,-	965-228	70,-	963-128	88,-

Price reduction



All-round bench scale, protected by stainless steel and IP65 rating, now also with EC type approval [M]

Features

- **1 Ideal for the increased hygienic requirements** in the food, pharmaceutical and chemical industries
- Your support in a **HACCP**-compliant quality system
- **2 Ideal for the robust industrial applications**
- **High mobility:** thanks to battery operation, compact, lightweight construction, it is suitable for the use in several locations (kitchen, sales office, cafeteria, Food industry-Laboratory etc.)
- **Stainless steel design** of the housing and weighing plate. Its smooth surfaces make it simple to clean
- **Recessed grips on the underside** of the scale for easy transportation

- **3 Protection against dust and water splashes IP65** (only when using rechargeable battery pack)

Technical data

- Large backlit LCD display, digit height 25 mm
- Dimensions weighing surface, stainless steel, WxD 230x190 mm
- Overall dimensions WxDxH 230x300x130 mm
- Rechargeable battery pack internal, operating time up to 50 h without backlight, charging time approx. 12 h
- Net weight approx. 4,0 kg
- Permissible ambient temperature
KERN FFN-N: 0 °C/40 °C
KERN FFN-NM: -10 °C/40 °C

Accessories

- **Tare pan made of stainless steel**, ideal for weighing loose small parts, fruit, vegetables etc., WxDxH 370x240x20 mm, KERN RFS-A02, € 55,-

STANDARD

CAL EXT	UNIT	IP 65	INOX	ACCU	MULTI	DMS	1 DAY
---------	------	-------	------	------	-------	-----	-------

OPTION

DAKKS +3 DAYS	FACTORY M +3 DAYS
------------------	-------------------------

Model	Weighing capacity [Max] kg	Readability [d] g	Verification value [e] g	Minimal load [Min] g	Price excl. of VAT ex works €	Option			
						Verification		DAkkS Calibr. Certificate	
						M KERN	€	DAkkS KERN	€
KERN									
FFN 1K-4N	1,5	0,2	-	-	260,-	-	-	963-127	72,-
FFN 3K0.5IPN	3	0,5	-	-	255,-	-	-	963-127	72,-
FFN 6K1IPN	6	1	-	-	255,-	-	-	963-128	88,-
FFN 15K2IPN	15	2	-	-	255,-	-	-	963-128	88,-
FFN 25K5IPN	25	5	-	-	255,-	-	-	963-128	88,-
Note: For applications that require verification, please order verification at the same time, initial verification at a later date is not possible. Verification at the factory, we need to know the full address of the location of use.									
FFN 1K-4NM	1,5	0,5	0,5	10	285,-	965-227	55,-	963-127	72,-
FFN 3K1IPM	3	1	1	20	285,-	965-227	55,-	963-127	72,-
FFN 6K2IPM	6	2	2	40	285,-	965-228	70,-	963-128	88,-
FFN 15K5IPM	15	5	5	100	285,-	965-228	70,-	963-128	88,-
FFN 25K10IPM	25	10	10	200	285,-	965-228	70,-	963-128	88,-



Robust, space-saving bench scale, protected by stainless steel and IP68 rating – with EC type approval [M]

Features

- **Suitable for the ever-increasing hygienic requirements** in the food industry
- Your support in a **HACCP-compliant** quality system
- **Ideal for the robust industrial applications protection against dust and water splashes IP68**, ideal for harsh ambient conditions. Submersion in water actually possible
- **Stainless steel design** of the housing and weighing plate. Its smooth surfaces make it simple to clean
- **Very fast display:** steady weight values within 2 s
- **High mobility:** thanks to battery operation, compact, lightweight construction, it is suitable for the use in several locations (kitchen, sales office, cafeteria, Food industry-Laboratory etc.)

- **1 Recessed grips on the underside** of the scale for easy transportation
- **Weighing with tolerance range (check-weighing):** a visual and audible signal helps with portioning, dispensing or grading

Technical data

- Large backlit LCD display (FXN-M: green), digit height 25 mm
- Dimensions weighing surface, stainless steel, WxD 236x195 mm
- Overall dimensions WxDxH 240x280x120 mm
- **Ready for use:** Batteries included, 4x1.5 V Size D, operating time up to 200 h, AUTO-OFF function to preserve the battery
- Net weight approx. 3,2 kg
- Permissible ambient temperature
KERN FXN-N: 0 °C/40 °C
KERN FXN-M: -10 °C/40 °C

Accessories

- **2 Tare pan made of stainless steel**, ideal for weighing loose small parts, fruit, vegetables etc., WxDxH 370x240x20 mm, KERN RFS-A02, € 55,-
- Further details, plenty of further accessories and suitable printers see *Accessories*

Note: Official verification duty for commercial trade

STANDARD								OPTION		FACTORY	
CAL EXT	PCS	UNIT	TOL	IP 68	INOX	BATT	DMS	1 DAY	DAkkS	M	+3 DAYS

Model	Weighing capacity [Max] kg	Readability [d] g	Verification value [e] g	Minimal load [Min] g	Smallest part weight [Normal] g/piece	Price excl. of VAT ex works €	Option				
							Verification		DAkkS Calibr. Certificate		
KERN								€	DAkkS KERN	€	
FXN 3K-4N	3	0,5	-	-	5	280,-	-	-	963-127	72,-	
FXN 6K-3N	6	1	-	-	10	280,-	-	-	963-128	88,-	
FXN 10K-3N	15	2	-	-	20	280,-	-	-	963-128	88,-	
FXN 30K-3N	30	5	-	-	50	280,-	-	-	963-128	88,-	
Note: For applications that require verification, please order verification at the same time, initial verification at a later date is not possible. Verification at the factory, we need to know the full address of the location of use.											
FXN 3K-3M	3	1	1	20	5	340,-	965-227	55,-	963-127	72,-	
FXN 6K-3M	6	2	2	40	10	340,-	965-228	70,-	963-128	88,-	
FXN 10K-3M	15	5	5	100	20	340,-	965-228	70,-	963-128	88,-	
FXN 30K-2M	30	10	10	200	50	340,-	965-228	70,-	963-128	88,-	



Stainless steel platform scales with IP65/67 protection, also with XL platform or EC type approval [M]

Features

- **Ideal for the robust industrial applications**
- **1 Platform:** made entirely of stainless steel, silicone-coated stainless steel load cell, protection against dust and water splashes IP67
- **2 Display device:** stainless steel, protection against dust and water splashes IP65, (only when using rechargeable battery pack)

- **3 SFB-H: Column,** standard, for models with weighing plate size 300x240 mm: Column height approx. 200 mm
400x300 mm: Column height approx. 200 mm

Technical data

- Large backlit LCD display, digit height 52 mm
- Dimensions of display device WxDxH 266x165x96 mm
- Cable length of display device approx. 3 m

- Rechargeable battery pack internal, operating time up to 35 h without backlight, charging time approx. 12 h
- Permissible ambient temperature -10 °C/40 °C

Accessories

- **Data interface RS-232,** interface cable included, approx. 1,5 m, must be ordered at purchase, KERN KFN-A01, **€ 95,-**
- **Stand** to be screwed onto the platform, height of stand approx. 600 mm, KERN SFB-A01, **€ 75,-**
- **4 Stand** to elevate display device, height of stand approx. 800 mm, **Stand** to elevate display device, height of stand approx. 800 mm, KERN BFS-A07, **€ 120,-**
- Further details, plenty of further accessories and suitable printers see *Accessories*

STANDARD: CAL EXT, GLP, PRINTER, PCS, SUM, TOL, IP 65, IP 67, INOX, ACCU, MULTI, DMS, 1 DAY

OPTION: DAKkS +3 DAYS

FACTORY: RS 232, +3 DAYS, SFB-M/SFB-HM

Model	Weighing capacity [Max] kg	Readability [d] g	Verification value [e] g	Minimal load [Min] g	Net weight approx. kg	Weighing plate WxD	Price excl. of VAT ex works €	Option				
								Verification		DAkkS Calibr. Certificate		
KERN							€	€	DAkkS KERN	€	€	
SFB 50K-3XL	50	5	-	-	14	500x400	870,-	-	-	963-128	88,-	-
SFB 100K-2L	100	10	-	-	14	500x400	910,-	-	-	963-129	105,-	-
SFB 100K-2XL	100	10	-	-	26	650x500	1130,-	-	-	963-129	105,-	-
SFB 200K-2XL	200	20	-	-	26	650x500	850,-	-	-	963-129	105,-	-
with elevated display												
SFB 10K1HIP	10	1	-	-	8	300x240	670,-	-	-	963-128	88,-	-
SFB 20K2HIP	20	2	2	-	8	300x240	670,-	-	-	963-128	88,-	-
SFB 50K5HIP	50	5	5	-	8	300x240	670,-	-	-	963-128	88,-	-
SFB 50K5LHIP	50	5	5	-	8	400x300	740,-	-	-	963-128	88,-	-
SFB 100K10HIP	100	10	-	-	14	400x300	730,-	-	-	963-129	105,-	-
Note: For applications that require verification, please order verification at the same time, initial verification at a later date is not possible. Verification at the factory, we need to know the full address of the location of use.												
SFB 60K-2XLM	60	20	20	400	16	500x400	1010,-	965-229	93,-	963-129	105,-	-
SFB 100K-2XLM	150	50	50	1000	24	650x500	1010,-	965-229	93,-	963-129	105,-	-
SFB 300K-1LM *	300	100	100	2000	26	650x500	860,-	965-229	93,-	963-129	105,-	-
with elevated display												
SFB 15K5HIPM	15	5	5	100	8	300x240	680,-	965-228	70,-	963-128	88,-	-
SFB 30K10HIPM	30	10	10	200	8	300x240	690,-	965-228	70,-	963-128	88,-	-
SFB 60K20LHIPM	60	20	20	400	14	400x300	740,-	965-229	93,-	963-129	105,-	-
SFB 100K-2HM	150	50	50	1000	13	400x300	760,-	965-229	93,-	963-129	105,-	-

* ONLY WHILE STOCKS LAST

Price reduction



Stainless steel platform scale with stainless steel IP68 display and EC type approval [M]

Features

- **Ideal for the robust industrial applications**
- **Platform:** made entirely of stainless steel, silicone-coated stainless steel load cell, protection against dust and water splashes IP68. Substruction in wing design, extremely resistant to bending. Earthed weighing plate, to reduce static charge
- **Display device:** stainless steel, protection against dust and water splashes IP68, integrated power supply
- **Suitable for the ever-increasing hygienic requirements** in the food industry
- **Wall mount** for display device, standard
- **Superior display size:** digit height 55 mm, bright backlight for easy reading of weighing results, even in poor lighting conditions
- Easy-to-use KERN menu structure with printout of weighing results which can be intuitively adapted

- Thanks to **interfaces** such as RS-232, RS-485 and Bluetooth (optional) the scale can easily be connected to existing networks and facilitates the data exchange between the scale and printer

Technical data

- Large backlit LCD display, digit height 55 mm
- Weighing plate dimensions, stainless steel W×D×H
 - A 300×240×86 mm
 - B 400×300×89 mm
 - C 500×400×123 mm
 - D 650×500×133,5 mm
- Dimensions of display device W×D×H 232×170×80 mm
- Cable length of display device approx. 2,5 m

Accessories

- **Stand** to elevate display device, must be ordered at purchase, for models with weighing plate size
 - A-D Height of stand approx. 200 mm, KERN IXS-A02, € 70,-
 - B-D Height of stand approx. 400 mm, KERN IXS-A03, € 75,-
 - C-D Height of stand approx. 600 mm, KERN IXS-A04, € 85,-
- **Rechargeable battery pack internal**, operating time up to 80 h without backlight, charging time approx. 12 h, must be ordered at purchase, KERN GAB-A04, € 40,-
- **Data interface RS-232**, interface cable included, approx. 1,5 m, must be ordered at purchase, KERN KXS-A04, € 100,-
- **Data interface RS-485**, must be ordered at purchase, KERN KXS-A01, € 145,-
- **Foot switch**, must be ordered at purchase, KERN KXS-A03, € 130,-
- **Bluetooth data interface** for wireless data transfer to PC or tablets, must be ordered at purchase, not in combination with verification, KERN KXS-A02, € 170,-
- Further details, plenty of further accessories and suitable printers see *Accessories*

STANDARD



OPTION



FACTORY

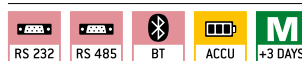

Model	Weighing capacity [Max] kg	Readability [d] g	Verification value [e] g	Minimal load [Min] g	Linearity g	Weighing plate	Price excl. of VAT ex works €	Option			
								Verification		DAkKS Calibr. Certificate	
KERN								M KERN	€	DAKKS KERN	€
SXS 6K-3M	3 6	1 2	1 2	20 40	± 1 2	A	670,-	965-228	70,-	963-128	88,-
SXS 10K-3M	6 15	2 5	2 5	40 100	± 2 5	A	670,-	965-228	70,-	963-128	88,-
SXS 10K-3LM	6 15	2 5	2 5	40 100	± 2 5	B	820,-	965-228	70,-	963-128	88,-
SXS 30K-2M	15 30	5 10	5 10	100 200	± 5 10	B	820,-	965-228	70,-	963-128	88,-
SXS 30K-2LM	15 30	5 10	5 10	100 200	± 5 10	C	1110,-	965-228	70,-	963-128	88,-
SXS 60K-2M	30 60	10 20	10 20	200 400	± 10 20	B	820,-	965-229	93,-	963-129	105,-
SXS 60K-2LM	30 60	10 20	10 20	200 400	± 10 20	C	1110,-	965-229	93,-	963-129	105,-
SXS 100K-2M	60 150	20 50	20 50	400 1000	± 20 50	C	1110,-	965-229	93,-	963-129	105,-
SXS 100K-2LM	60 150	20 50	20 50	400 1000	± 20 50	D	1370,-	965-229	93,-	963-129	105,-
SXS 300K-2M	150 300	50 100	50 100	1000 2000	± 50 100	D	1370,-	965-229	93,-	963-129	105,-

Dual-range balance switches automatically to the next largest weighing capacity [Max] and readability [d]

Note: For applications that require verification, please order verification at the same time, initial verification at a later date is not possible.

Verification at the factory, we need to know the full address of the location of use.

Price reduction

Price computing scales

Price computing scales are used wherever the price of goods is calculated dependent on the weight of the goods. These scales are subject to obligatory verification (► **Verification**) in accordance with European Directive 2014/31/EU. Usually, are verification class **MIII** scales

KERN mobile retail scales are compact in size and therefore save space on the sales counter. Thanks to the simple menu structure they are easy to use – saving time and money. Fitted with mains or rechargeable batteries as standard, price computing scales can be used in retail shops as well as on mobile sales stalls.

All price computing scales from KERN have three displays showing you all important information at a glance:

- Weight display in kg (verifiable)
- Unit price in €/kg or €/100 g
- Total price in €

NOTE: The KERN RFE range also displays the TARE or PRE-TARE value, which enables this value to be stored in a legally binding way in accordance with the Weights and Measures Act.

Even the KERN entry level retail scales have direct access keys for memories (► **PLU**), The sales item with the relevant price can be stored against these PLU. In this way, frequently used sales items can be called up at lightning speed. This accelerates customer service and reduces waiting times.

► See the glossary on page 206–208

Quick-Finder Price computing scales

Readability [d] g	Weighing capacity [Max] kg	Model KERN	Price excl. of VAT ex works €	Page	DAYS	M	CAL EXT	RS 232	MEMORY	IP	ACCU	For an explanation on the pictos, see front flap												
												1	2	3	4	5	6	7	8	9	10	11	12	
1 2	3 6	RIB 6K-3M	205,-	81	1	○	●					○												
1 2	3 6	RIB 6K-3HM	235,-	81	1	○	●					○												
1 2	3 6	RPB 6K1DM	205,-	82	1	○	●		●	●		○												
1 2	3 6	RPB 6K1DHM	220,-	82	1	○	●		●	●		○												
1 2	3 6	RFE 6K3M	280,-	83	1	○	●		●	●	●	○												
2 5	6 15	RIB 10K-3M	205,-	81	1	○	●					○												
2 5	6 15	RIB 10K-3HM	235,-	81	1	○	●					○												
2 5	6 15	RPB 15K2DM	205,-	82	1	○	●		●	●		○												
2 5	6 15	RPB 15K2DHM	220,-	82	1	○	●		●	●		○												
2 5	6 15	RFE 15K3M	280,-	83	1	○	●		●	●	●	○												
5 10	15 30	RIB 30K-2M	205,-	81	1	○	●					○												
5 10	15 30	RIB 30K-2HM	235,-	81	1	○	●					○												
5 10	15 30	RPB 30K5DM	205,-	82	1	○	●		●	●		○												
5 10	15 30	RPB 30K5DHM	220,-	82	1	○	●		●	●		○												
5 10	15 30	RFE 30K3M	280,-	83	1	○	●		●	●	●	○												

● = standard ○ = option



Lisa Haib

Product specialist Price computing scales

Tel. +49 7433 9933-219
Fax +49 7433 9933-29219
lisa.haib@kern-sohn.com

HIGHLIGHT



from €
205,-

- Intuitive operation
- Little space requirements
- Mains operation and rechargeable battery pack possible
- Second display which can be fitted on the back of the balance



Robust retail scale with large item memory, user-friendly handling and EC type approval [M]

Features

- **1** KERN RIB-HM: **Elevated display backlit**, height of stand approx. 530 mm, must be ordered at purchase
- **2** KERN RIB-M: **Second display** on the rear of the balance
- **Three displays** for weight display (verifiable), unit price, total price
- **Calculation of change**
- **Soil-resistant construction** through water channels at the frame of the housing and sealing rings over the upper housing inlets
- **10 Direct price keys** for frequently recurring article prices
- **Memory (PLU) for 20 article prices**
- **Energy management:** Backlight turns off after 5 s, can be switched off
- **Soil-resistant construction** through water channels at the frame of the housing and sealing rings over the upper housing inlets

- **Protective working cover** included with delivery

Technical data

- Large backlit LCD displays, digit height 18 mm
- Dimensions weighing surface, stainless steel, W×D 294×225 mm
- Overall dimensions W×D×H
KERN RIB-M: 325×400×115 mm
KERN RIB-HM: 325×400×400 mm
- Net weight
KERN RIB-M: approx. 3,2 kg
KERN RIB-HM: approx. 3,8 kg
- Permissible ambient temperature -10 °C/40 °C

Accessories

- **Protective working cover**, scope of delivery: 5 items, KERN RIB-A01S05, **€ 40,-**
- **Rechargeable battery pack internal**, operating time up to 80 h without backlight, charging time approx. 14 h, KERN GAB-A04, **€ 40,-**
- **Tare pan made of stainless steel**, ideal for weighing loose small parts, fruit, vegetables etc., W×D×H 370×240×20 mm, KERN RFS-A02, **€ 55,-**

Application examples

- retail shops
- weekly markets
- farm shops
- pick your own fruit and vegetable sales

Note: Official verification duty for commercial trade

STANDARD						OPTION		FACTORY	
CAL EXT	MEMORY	UNIT	DMS	1 DAY	230 V	ACCU	+3 DAYS	M	+3 DAYS

Model	Weighing capacity [Max] kg	Readability [d] g	Verification value [e] g	Minimal load [Min] g	Price excl. of VAT ex works €	Option				
						Verification		DAkkS Calibr. Certificate		
KERN							€	DAkkS KERN	€	
Dual-range balance switches automatically to the next largest weighing capacity [Max] and readability [d]										
RIB 6K-3M	3 6	1 2	1 2	20 40	205,-	965-228	70,-	963-128	88,-	
RIB 10K-3M	6 15	2 5	2 5	40 100	205,-	965-228	70,-	963-128	88,-	
RIB 30K-2M	15 30	5 10	5 10	100 200	205,-	965-228	70,-	963-128	88,-	
with elevated display										
RIB 6K-3HM	3 6	1 2	1 2	20 40	235,-	965-228	70,-	963-128	88,-	
RIB 10K-3HM	6 15	2 5	2 5	40 100	235,-	965-228	70,-	963-128	88,-	
RIB 30K-2HM	15 30	5 10	5 10	100 200	235,-	965-228	70,-	963-128	88,-	

Note: For applications that require verification, please order verification at the same time, initial verification at a later date is not possible.
Verification at the factory, we need to know the full address of the location of use.

Price reduction



Retail scale with memories for item prices

Features

- **NEW:** modern, ergonomic design and a housing which is even more compact, supporting efficient operation and saving space
- **1** KERN RPB-HM: **Elevated display backlight**, revolving on column, height of stand approx. 480 mm, must be ordered at purchase
- **2** KERN RPB-M: **Second display** on the rear of the balance
- **Three displays** for weight display (verifiable), unit price, total price
- **Calculation of change**
- **Memory (PLU) for 10 article prices**
- **Unit price can be switched** from €/kg to €/100 g
- **Auto-clear-key:** Unit price entry is automatically set to zero when scale is unloaded
- **3 High mobility:** thanks to rechargeable battery operation (optional), compact, lightweight construction, it is suitable for the use in several locations

- **Protective working cover** included with delivery

Technical data

- Large backlit LCD displays, digit height 15 mm
- Dimensions weighing surface, stainless steel, WxD 204x263 mm
- Overall dimensions WxDxH
RPB-M: 310x270x65 mm
RPB-HM: 310x270x545 mm
- Net weight
KERN RPB-M: approx. 2,8 kg
KERN RPB-HM: approx. 3,2 kg
- Permissible ambient temperature -10 °C/40 °C

Accessories

- **Protective working cover**, scope of delivery: 5 items, KERN CFS-A02S05, **€ 40,-**
- **Internal rechargeable battery pack**, operating time up to 60 h without backlight, charging time approx. 12 h, KERN GAB-A04, **€ 40,-**
- **4 Tare pan made of stainless steel**, ideal for weighing loose small parts, fruit, vegetables etc., WxDxH 370x240x20 mm, KERN RFS-A02, **€ 55,-**
- Further details, plenty of further accessories and suitable printers see *Accessories*

Application examples

- retail shops
- weekly markets
- farm shops
- pick your own fruit and vegetable sales

Note: Official verification duty for commercial trade



Model	Weighing capacity [Max] kg	Readability [d] g	Verification value [e] g	Minimal load [Min] g	Price excl. of VAT ex works €	Option			
						Verification		DAkkS Calibr. Certificate	
KERN						M KERN	€	DAKKS KERN	€
Dual-range balance switches automatically to the next largest weighing capacity [Max] and readability [d]									
RPB 6K1DM	3 6	1 2	1 2	20	205,-	965-228	70,-	963-128	88,-
RPB 15K2DM	6 15	2 5	2 5	40	205,-	965-228	70,-	963-128	88,-
RPB 30K5DM	15 30	5 10	5 10	100	205,-	965-228	70,-	963-128	88,-
with elevated display									
RPB 6K1DHM	3 6	1 2	1 2	20	220,-	965-228	70,-	963-128	88,-
RPB 15K2DHM	6 15	2 5	2 5	40	220,-	965-228	70,-	963-128	88,-
RPB 30K5DHM	15 30	5 10	5 10	100	220,-	965-228	70,-	963-128	88,-

Note: For applications that require verification, please order verification at the same time, initial verification at a later date is not possible.
Verification at the factory, we need to know the full address of the location of use.

↓ Price reduction



Compact portion scale with 2 XXL displays – weight, unit price, total price and TARE value at a glance

Features

- Ideal as a salad scale, sweet scale, check-weigher, portion scale or zero-waste scale: Shopping without plastic or packaging waste in packaging-free supermarkets
- **Large LCD display with four displays** for weight display (verifiable), unit price, total price and stored TARE or PRE-TARE value
- TARE value display: this shows a TARE or PRE-TARE value stored in a PLU, which enables this value to be stored in a legally binding way in accordance with the Weights and Measures Act
- **1 Second display** on the rear of the balance
- **2 Column** to elevate the display as standard, can be easily fitted or removed by the user. The power cable for the second display can be stored in the folding column which is hygienic and gives a tidy appearance. Column height approx. 395 mm
- **3** Thanks to easily-understandable, universal symbols e.g. for weight, piece weight, total price this balance can also be understood and operated easily all over the world
- **Calculation of change**

- **4 Direct price keys** for frequently recurring article prices
- **Memory (PLU) for 100 article prices**
- Item description can be entered, stored and shown on the display in clear text
- **Unit price can be switched** from €/kg to €/100 g
- **Auto-clear-key:** Unit price entry is automatically set to zero when scale is unloaded
- **Headers and footers of the printout** can be programmed directly on the balance
- **High mobility:** thanks to rechargeable battery operation (optional), compact, lightweight construction, it is suitable for the use in several locations
- **Recessed grips on the underside** of the scale for easy transportation

Technical data

- Large backlit LCD display, digit height 20 mm
- Dimensions weighing surface, stainless steel, WxD 230x300 mm
- Overall dimensions WxDxH 320x450x130 mm
- Net weight approx. 4,2 kg
- Permissible ambient temperature -10 °C/40 °C

Accessories

- **Label printer** for printing weights on thermal labels, ASCII-capable, for further details, see Accessories, KERN YKE-01, € 590,-
- **Rechargeable battery pack internal**, operating time up to 60 h with backlight, charging time approx. 12 h, KERN GAB-A04, € 40,-

Application examples

- cafeterias, restaurants, Motorway service stations
- retail shops
- weekly markets
- farm shops
- pick your own fruit and vegetable sales

Note: Official verification duty for commercial trade



Model	Weighing capacity [Max] kg	Readability [d] g	Verification value [e] g	Minimal load [Min] g	Price excl. of VAT ex works €	Option			
						Verification		DAkKS Calibr. Certificate	
							€	DAkKS	€
RFE 6K3M	3 6	1 2	1 2	20	280,-	965-228	70,-	963-128	88,-
RFE 15K3M	6 15	2 5	2 5	40	280,-	965-228	70,-	963-128	88,-
RFE 30K3M	15 30	5 10	5 10	100	280,-	965-228	70,-	963-128	88,-

Note: For applications that require verification, please order verification at the same time, initial verification at a later date is not possible. Verification at the factory, we need to know the full address of the location of use.

Price reduction

Counting scales/Counting systems

Interesting facts about density determination

Smallest part weight when counting

Smallest piece the scale will accept for piece counting and piece count display. In practice, depending on the required accuracy, we recommend to choose a counting scale with a minimum piece weight smaller than the weight of the item to be counted. To make it easier for you to select the right model, we give the smallest part weight when counting under laboratory conditions and normal conditions, see the website.

► Counting resolution

Describes the maximum quantity which can be counted with a counting accuracy of 1 %, with a minimum variation of item weights and a sufficiently large ► **reference quantity** (20 pieces with counting resolution $\leq 60,000$ points, 50 pieces from 60,000–150,000 points, 100 pieces $\geq 150,000$ points). This therefore is an indication of the quality of the counting scale.

Recommended ► reference quantity

Weight tolerances of pieces to be counted are the most significant sources of error when counting. Therefore, at the start of every counting procedure, establish an average weight, the so-called ► **reference weight**, by placing several pieces on the balance, the so-called reference quantity. Usually this would be:

5 pieces	>> often sufficient
10 pieces	>> common practise
20–100 pieces	>> for large deviations among piece weights

The “automatic ► **reference optimisation**” function increases the reference quantity gradually, whereby the average piece weight is optimised step by step. This contributes considerably to the accuracy of the subsequent counting processes.

Which counting scale for which application?

Simple counting scale

with self-explanatory user guidance on the keyboard. The graphic control panel enables you to start working immediately, without having to consult the user manual. Easy handling, value for money.

Professional counting scale

with 3 separate displays for reference weight (average weight of the pieces), total weight of all pieces and total quantity of all pieces. Very useful integrated memories, e.g. for container weight, item number, reference weight as well as audible and visual counting aids and an alphanumeric key pad for easy data entry.

Special tip for counting large quantities:

Counting systems

The weighing capacities of bench counting scales are often not sufficient to count large quantities, units, palletized items, etc. Here high-performance counting systems come into operation, as these combine a high-precision reference scale with a high-capacity bulk scale.

► See the glossary on page 206–208



Bettina Schwedt

Product specialist Counting scales

Tel. +49 7433 9933-141

Fax +49 7433 9933-29141

bettina.schwedt@kern-sohn.com

HIGHLIGHT



- Three displays for: weight display (verifiable), reference weight, total count
- Target quantity or target weight can be programmed, e.g. for Checkweighing
- High mobility: thanks to battery operation and compact, flat construction, it is suitable for use in several locations (production, warehouse, dispatch department,...)



Note: Official verification duty for commercial trade

Entry level model into professional counting, also with EC type approval [M], counting resolution of 30,000 points

Features

- **Precise counting:** The automatic reference weight optimisation of reference weight gradually improves the average piece weight value
- **Programmable using numerical key pad:**
 - required reference quantity
 - known reference weight
- **Three displays** for weight display (verifiable), reference weight, total pieces
- **Audible Fill-to-target:** target quantity or target weight can be programmed, e. g. for checkweighing. When the target value is reached, a signal will sound
- 10 Memories for reference weights
- **Counting results memory:** adds up all individual piece counts, result is shown in total weight and total pieces
- **Energy management:** Backlight turns off after 5 s

- **PRE-TARE function** for manual subtraction of a known container weight, useful for checking fill-levels
- **Two balances in one:** Changes from counting mode to weighing mode at the touch of a key
- **Protective working cover** included with delivery

Accessories

- **Protective working cover**, scope of delivery: 5 items, KERN CXB-A01S05, € 40,-
- **Rechargeable battery pack internal**, operating time up to 200 h without backlight, charging time approx. 8 h, KERN GAB-A04, € 40,-

Technical data

- Large backlit LCD displays, digit height 18 mm
- Dimensions weighing surface, stainless steel, WxD 300x225 mm
- Dimensions housing WxDxH, 300x330x110 mm
- Rechargeable battery pack internal, operating time up to 200 h without backlight, charging time approx. 8 h
- Permissible ambient temperature -10 °C/40 °C

STANDARD

CAL EXT	PCS	SUM	ACCU	230 V	DMS	1 DAY

OPTION FACTORY

DAKKS	M
+3 DAYS	+3 DAYS
	CXB-NM

Model	Weighing capacity [Max] kg	Readability [d] g	Verification value [e] g	Minimal load [Min] g	Smallest part weight [Normal] g/piece	Counting resolution Points	Net weight approx. kg	Price excl. of VAT ex works €	Option			
									Verification		DAKKS Calibr. Certificate	
										KERN	€	DAKKS KERN
KERN CXB 3K0.2	3	0,2	-	-	1	30.000	4,0	230,-	-	-	963-127	72,-
KERN CXB 6K0.5	6	0,5	-	-	2	30.000	4,0	230,-	-	-	963-128	88,-
KERN CXB 15K1	15	1	-	-	5	30.000	4,0	230,-	-	-	963-128	88,-
KERN CXB 30K2	30	2	-	-	10	30.000	4,2	230,-	-	-	963-128	88,-
Note: For applications that require verification, please order verification at the same time, initial verification at a later date is not possible. Verification at the factory, we need to know the full address of the location of use.												
KERN CXB 3K1NM	3	1	1	20	1	30.000	4,0	245,-	965-227	55,-	963-127	72,-
KERN CXB 6K2NM	6	2	2	40	2	30.000	4,2	245,-	965-228	70,-	963-128	88,-
KERN CXB 15K5NM	15	5	5	100	5	30.000	4,0	245,-	965-228	70,-	963-128	88,-
KERN CXB 30K10NM	30	10	10	200	10	30.000	4,2	245,-	965-228	70,-	963-128	88,-



Note: Official verification duty for commercial trade

Professional model, also with EC type approval [M], counting resolution up to 60,000 points

Features

- **Precise counting:** The automatic reference weight optimisation of reference weight gradually improves the average piece weight value
- **Programmable using numerical key pad:**
 - required reference quantity
 - known reference weight
- **Three displays** for weight display (verifiable), reference weight, total pieces
- **Counting results memory:** adds up all individual piece counts, result is shown in total weight and total pieces
- **Audible Fill-to-target:** target quantity or target weight can be programmed, e. g. for checkweighing. When the target value is reached, a signal will sound
- **PRE-TARE function** for manual subtraction of a known container weight, useful for checking fill-levels

- **High mobility:** thanks to rechargeable battery operation (optional), compact, lightweight construction, it is suitable for the use in several locations (production, warehouse, dispatch department etc.)
- **Two balances in one:** Changes from counting mode to weighing mode at the touch of a key
- **Protective working cover** included with delivery

Technical data

- Large backlit LCD displays, digit height 20 mm
- Dimensions weighing surface, stainless steel, WxD 295x225 mm
- Overall dimensions WxDxH 315x350x105 mm
- Net weight approx. 3,2 kg
- Permissible ambient temperature 0 °C/40 °C

Accessories

- **Protective working cover**, scope of delivery: 5 items, KERN CFS-A02S05, € 40,-
- **Rechargeable battery pack internal**, operating time up to 90 h without backlight, charging time approx. 12 h, KERN GAB-A04, € 40,-
- **Signal lamp** for visual support of weighing with tolerance range, KERN CFS-A03, € 250,-
- **Y-cable** for parallel connection of two terminal devices to the RS-232 interface on the scale, e.g. signal lamp or barcode reader and printer, KERN CFS-A04, € 35,-
- Further details, plenty of further accessories and suitable printers see *Accessories*

STANDARD

CAL EXT | RS 232 | PCS | SUM | TOL | MULTI | DMS | 1 DAY

OPTION

ACCU | DAKKS +3 DAYS

FACTORY

M +3 DAYS CPB-DM

Model	Weighing capacity [Max] kg	Readability [d] g	Verification value [e] g	Minimal load [Min] g	Smallest part weight [Normal] g/piece	Counting resolution Points	Price excl. of VAT ex works €	Option			
								Verification		DAkkS Calibr. Certificate	
KERN								M KERN	€	DAkkS KERN	€
CPB 6K0.1N	6	0,1	-	-	1	60.000	225,-	-	-	963-128	88,-
CPB 15K0.2N	15	0,2	-	-	2,5	60.000	225,-	-	-	963-128	88,-
CPB 30K0.5N	30	0,5	-	-	5	60.000	225,-	-	-	963-128	88,-

Dual-range balance switches automatically to the next largest weighing capacity [Max] and readability [d]

Note: For applications that require verification, please order verification at the same time, initial verification at a later date is not possible.

Verification at the factory, we need to know the full address of the location of use.

CPB 6K1DM	3 6	1 2	1 2	20	1	60.000	225,-	965-228	70,-	963-128	88,-
CPB 15K2DM	6 15	2 5	2 5	40	2,5	60.000	225,-	965-228	70,-	963-128	88,-
CPB 30K5DM	15 30	5 10	5 10	100	5	60.000	225,-	965-228	70,-	963-128	88,-

Price reduction



Professional, high-resolution counting scale with 100 item memories and second balance interface, counting resolution up to 75,000 points

Features

- **Memory (PLU)** for 100 items with additional text, reference weight and tare weight, e.g. of a container
- **Precise counting:** The automatic reference weight optimisation of reference weight gradually improves the average piece weight value
- **Programmable using numerical key pad:**
 - required reference quantity
 - known reference weight
- **Three displays** for weight display (verifiable), reference weight, total pieces
- **Weighing with tolerance range (check-weighing):** a visual and audible signal helps with portioning, dispensing or grading
- **Fill-to-target function**
Programmable target quantity or target weight. A signal will be displayed when the target value is reached
- **PRE-TARE function** for manual subtraction of a known container weight, useful for checking fill-levels

- **Second balance interface** to construct a high-resolution counting system, standard, e.g. with weighing bridges of KERN
- **Protective working cover** included with delivery, for models with weighing plate size **A**, **B**

Technical data

- Large backlit LCD displays, digit height 20 mm
- Dimensions weighing surface
 - A** Ø 80 mm
 - B** WxD 295x225 mm
 - C** WxD 295x225 mm
- Overall dimensions WxDxH
 - A** 320x350x180 mm (incl. draught shield)
 - B** 320x350x110 mm
 - C** 365x250x125 mm
- Permissible ambient temperature 0 °C/40 °C

Accessories

- **Protective working cover**, standard for models with weighing plate size **A**, **B**, scope of delivery: 5 items, KERN CFS-A02S05, **€ 40,-**
- **Rechargeable battery pack internal**, operating time up to 70 h without backlight, charging time approx. 14 h, KERN GAB-A04, **€ 40,-**
- **Signal lamp** for visual support of weighing with tolerance range, KERN CFS-A03, **€ 250,-**
- **Y-cable** for parallel connection of two terminal devices to the RS-232 interface on the scale, e.g. signal lamp or barcode reader and printer, KERN CFS-A04, **€ 35,-**
- Further details, plenty of further accessories and suitable printers see *Accessories*

STANDARD										OPTION		FACTORY

Model	Weighing capacity [Max] kg	Readability [d] g	Smallest part weight [Normal] g/piece	Counting resolution Points	Net weight approx. kg	Weighing plate	Price excl. of VAT ex works €	Option	
								DAkKS KERN	Calibr. Certificate €
KERN CFS 300-3	0,3	0,001	0,05	60.000	2,6	A	360,-	963-127	72,-
CFS 3K-5	3	0,01	0,5	60.000	3,4	B	310,-	963-127	72,-
CFS 6K0.1	6	0,1	1	60.000	3,2	B	270,-	963-128	88,-
CFS 15K0.2	15	0,2	2	75.000	3,4	B	270,-	963-128	88,-
CFS 30K0.5	30	0,5	5	60.000	3,4	B	270,-	963-128	88,-
CFS 50K-3	50	1	10	50.000	4,4	C	295,- ↓	963-128	88,-

↓ Price reduction



Easy to use, self-explanatory counting scale with laboratory accuracy, counting resolution up to 360,000 points

Features

- **Self-explanatory graphic control panel**, the workings steps can be understood immediately, even without operating instructions
 - no learning time = reduces costs
 - ideal for untrained users
 - visualised process avoids operating errors
- The 4 steps are carried out from left to right:
 - 1 Place the empty container onto the weighing plate and tare by pressing the TARE key
 - 2 Place the reference quantity for the goods to be counted into the container (5, 10 or 20 pieces)
 - 3 Confirm the selected reference quantity by pressing the key (5, 10 or 20)
 - 4 Pour in the goods to be counted. The number of pieces will immediately be shown in the display

- **Precise counting:** The automatic reference weight optimisation of reference weight gradually improves the average piece weight value
- **Two balances in one:** Changes from counting mode to weighing mode at the touch of a key
- **Protective working cover** included with delivery

Technical data

- Large backlit display
 - A, B digit height 9 mm
 - C digit height 18 mm
- Dimensions weighing surface
 - A \varnothing 81 mm, plastic
 - B WxD 150x170 mm, stainless steel
 - C 6 340x240 mm, stainless steel

- Overall dimensions WxDxH
 - A, B 167x250x85 mm
 - C 350x390x120 mm
- Optional battery operation, 6x1.5 V Size C not included, operating time up to 40 h, for models with weighing plate size C
- Permissible ambient temperature 10 °C/40 °C

Accessories

- **Protective working cover**, scope of delivery: 5 items, for models with weighing plate size
 - A KERN PCB-A02S05, € 40,-
 - B KERN PCB-A05S05, € 40,-
 - C KERN FKB-A02S05, € 40,-
- **Rechargeable battery pack external**, operating time up to 30 h without backlight, charging time approx. 10 h, KERN KS-A01, € 160,-
- **Internal rechargeable battery pack**, operating time up to 30 h without backlight, charging time approx. 10 h, for models with weighing plate size A, B, KERN KB-A01N, € 50,-
- Further details, plenty of further accessories and suitable printers see *Accessories*

STANDARD



OPTION



Model	Weighing capacity [Max] kg	Readability [d] g	Smallest part weight [Normal] g/piece	Counting resolution Points	Net weight approx. kg	Weighing plate	Price excl. of VAT ex works €	Option	
								DAkKS Calibr. Certificate	€
KERN								DAKKS KERN	
CKE 360-3	0,36	0,001	0,01	360.000	1	A	310,-	963-127	72,-
CKE 2000-2	2	0,01	0,1	200.000	1,8	B	350,-	963-127	72,-
CKE 3600-2	3,6	0,01	0,1	360.000	1,8	B	370,-	963-127	72,-
CKE 6K0.02	6	0,02	0,2	300.000	7	C	520,-	963-128	88,-
CKE 8K0.05	8	0,05	0,5	160.000	7	C	480,-	963-128	88,-
CKE 16K0.05	16	0,05	0,5	320.000	7	C	590,-	963-128	88,-
CKE 16K0.1	16	0,1	1	160.000	7	C	480,-	963-128	88,-
CKE 36K0.1	36	0,1	1	360.000	7	C	540,-	963-128	88,-
CKE 65K0.2	65	0,2	2	325.000	7	C	540,-	963-129	105,-
CKE 65K0.5	65	0,5	5	130.000	7	C	500,-	963-129	105,-



Industrial counting scale with convenient decimal keypad for easy data entry – now also with EC type approval [M], counting resolution up to 75000 points

Features

- **Tough industry standard** suitable for use in harsh industrial applications
- **Ergonomic display device** with large keypad and high-contrast LCD display for easy entry and reading of, e.g., tare weights, reference weights, limit values etc.
- **Three displays** for weight display (verifiable), reference weight, total pieces
- **100 item memories** for master data such as reference weight, reference quantity, container weight (PRE-TARE) etc.
- Printout of date and time for GLP and GMP compliant data logging

- **Precise counting:** The manual reference weight optimisation gradually improves the average value of the piece weight
- **Totalising** of pieces when counting
- **Protective working cover** included with delivery

Technical data

- Large backlit LCD displays, digit height 16,5 mm
- Dimensions weighing surface, stainless steel
 - A 230×230×110 mm
 - B 300×240×110 mm
 - C 400×300×120 mm
 - D 500×400×140 mm
 - E 650×500×140 mm

- Dimensions of display device W×D×H 260×150×65 mm
- Cable length of display device approx. 3 m
- Permissible ambient temperature -10 °C/40 °C

Accessories

- **Protective working cover**, scope of delivery: 5 items, KERN KFB-A02S05, **€ 40,-**
- **Stand** to elevate display device, Height of stand approx. 330 mm, for models with weighing plate size **A, C, D, E**, KERN IFB-A01, **€ 50,-**
Column height approx. 600 mm, for models with weighing plate size **D, E**, KERN IFB-A02, **€ 60,-**
- **Rechargeable battery pack internal**, operating time up to 40 h, without backlight, charging time approx. 12 h, must be ordered at purchase, KERN KFB-A01, **€ 35,-**
- Further details, plenty of further accessories and suitable printers see *Accessories*

STANDARD: CAL EXT, MEMORY, RS 232, GLP, INTERN, PCS, SUM, PERCENT, TOL, MULTI, DMS, 1 DAY

OPTION: DAKKS +3 DAYS

FACTORY: ACCU, M +3 DAYS

Model	Weighing capacity [Max] kg	Readability [d] g	Verification value [e] g	Smallest part weight [Normal] g/piece	Counting resolution Points	Net weight approx. kg	Weighing plate	Price excl. of VAT ex works €	Option			
									Verification		DAkKS Calibr. Certificate	
KERN								M KERN	€	DAkKS KERN	€	
Dual-range balance switches automatically to the next largest weighing capacity [Max] and readability [d]												
IFS 6K-4S	3 6	0,1 0,2	-	1	60.000	4,6	A	390,-	-	-	963-128	88,-
IFS 10K-4	6 15	0,1 0,2	-	2	75.000	6	B	405,-	-	-	963-128	88,-
IFS 30K0.2DL	12 30	0,2 0,5	-	5	60.000	11	C	450,-	-	-	963-128	88,-
IFS 60K0.5D	30 60	0,5 1	-	10	60.000	10	B	450,-	-	-	963-129	105,-
IFS 60K0.5DL	30 60	0,5 1	-	10	60.000	12	C	550,-	-	-	963-129	105,-
IFS 100K-3	75 150	1 2	-	25	60.000	12	D	630,-	-	-	963-129	105,-
IFS 100K-3L	75 150	1 2	-	25	60.000	20	E	790,-	-	-	963-129	105,-
IFS 300K-3	150 300	2 5	-	50	60.000	22	E	790,-	-	-	963-129	105,-

Note: For applications that require verification, please order verification at the same time, initial verification at a later date is not possible. Verification at the factory, we need to know the full address of the location of use.

IFS 6K-3SM	3 6	1 2	1 2	1	60.000	6	A	350,-	965-228	70,-	963-128	88,-
IFS 6K-3M	3 6	1 2	1 2	1	60.000	6	B	410,-	965-228	70,-	963-128	88,-
IFS 10K-3M	6 15	2 5	2 5	2	75.000	6	B	410,-	965-228	70,-	963-128	88,-
IFS 10K-3LM	6 15	2 5	2 5	2	75.000	10	C	460,-	965-228	70,-	963-128	88,-
IFS 30K-3M	15 30	5 10	5 10	5	60.000	10	C	460,-	965-228	70,-	963-128	88,-
IFS 60K-2M	30 60	10 20	10 20	10	60.000	11	C	460,-	965-229	93,-	963-129	105,-
IFS 60K-2LM	30 60	10 20	10 20	10	60.000	13	D	550,-	965-229	93,-	963-129	105,-
IFS 100K-2M	60 150	20 50	20 50	25	60.000	12	D	550,-	965-229	93,-	963-129	105,-
IFS 100K-2LM	60 150	20 50	20 50	25	60.000	22	E	720,-	965-229	93,-	963-129	105,-



Easy to use industrial counting scale for heavy loads, counting resolution up to 300,000 points

Features

- **Self-explanatory graphic control panel**, the workings steps can be understood immediately, even without operating instructions
 - no learning time = reduces costs
 - ideal for untrained users
 - visualised process avoids operating errors
- The 4 steps are carried out from left to right:
 - 1 Place the empty container onto the weighing plate and tare by pressing the TARE key
 - 2 Place the reference quantity for the goods to be counted into the container (5, 10 or 20 pieces)
 - 3 Confirm the selected reference quantity by pressing the key (5, 10 or 20)
 - 4 Pour in the goods to be counted. The number of pieces will immediately be shown in the display
- **Precise counting:** The automatic reference weight optimisation of reference weight gradually improves the average piece weight value
- **Protective working cover** included with delivery

Technical data

- Backlit LCD display, digit height 18 mm
- Dimensions weighing surface, stainless steel
 - A WxD 228x228 mm
 - B WxD 308x318 mm
 - C WxD 450x350 mm
- Dimensions of display device WxDxH 225x115x60 mm
- Permissible ambient temperature 10 °C/40 °C

Accessories

- **Protective working cover** over the display device, scope of delivery: 5 items, KERN DE-A12S05, € 40,-
- **Mount to fasten the display device** to the platform, KERN DE-A11N, € 35,-
- **Stand** to elevate display device, height of stand approx. 480 mm, can be reordered, KERN DE-A10, € 100,-
- **Rechargeable battery pack external**, operating time up to 30 h without backlight, charging time approx. 10 h, KERN KS-A01, € 160,-
- **Rechargeable battery pack internal**, operating time up to 30 h without backlight, charging time approx. 10 h, KERN KB-A01N, € 50,-
- **Set for underfloor weighing**, consists of platform, bow, hook, only for models with weighing plate B, KERN DS-A01, € 200,-
- Further details, plenty of further accessories and suitable printers see *Accessories*

STANDARD						OPTION		
						B		

Model	Weighing capacity [Max] kg	Readability [d] g	Smallest part weight [Normal] g/piece	Counting resolution Points	Net weight approx. kg	Cable length approx. m	Weighing plate	Price excl. of VAT ex works €	Option	
									DAkkS KERN	€
CDS 4K0.02	4	0,02	0,2	200.000	6	2	A	560,-	963-127	72,-
CDS 15K0.05	15	0,05	0,5	300.000	8	2	B	490,-	963-128	88,-
CDS 16K0.1	16	0,1	1	160.000	8	2	B	460,-	963-128	88,-
CDS 30K0.1	30	0,1	1	300.000	8	2	B	560,-	963-128	88,-
CDS 30K0.1L	30	0,1	1	300.000	10	0,6	C	710,-	963-128	88,-
CDS 36K0.2L	36	0,2	2	180.000	10	0,6	C	710,-	963-128	88,-
CDS 60K0.2	60	0,2	2	300.000	10	0,6	C	710,-	963-129	105,-



Counting system to count the smallest parts in the largest quantities, counting resolution up to 999,999 points

10

Features

- The highly accurate KERN CCS counting system can replace a whole range of individual balances, efficiently and at a reasonable price

Reference scale KERN CFS

- This professional counting scale, which can also be used as a stand-alone scale, meets the highest demands for accuracy, weighing capacity and volume of items, by being connected to a high-capacity weighing bridge
- **Programmable using numerical key pad:**
 - required reference quantity
 - known reference weight
- **Three displays** for weight display reference weight, total pieces
- **Memory (PLU)** for 100 items with additional text, reference weight and tare weight, e.g. of a container
- **Fill-to-target function**
Programmable target quantity or target weight. A signal will be displayed when the target value is reached
- **Precise counting:** The automatic reference weight optimisation of reference weight gradually improves the average piece weight value
- **Protective working cover** included with delivery

Quantity scale KERN KFP-V20 IP65, KFP-V20 IP67, KFU-V20

- The high-accuracy quantity counting takes place on the weighing platform (= weighing bridge) KERN CCS. In this way even the smallest of parts can be counted in large volumes
- **Weighing plate stainless steel**, painted steel base, for models with weighing plate size **A** - **E**
- **Aluminium Single-Point load cell** (1×3000 e), protection against dust and water splashes IP65

Technical data

Reference scale KERN CFS

- Overall dimensions W×D×H 320×350×180 mm
- Dimensions weighing surface, stainless steel
 - I** CFS 300-3: \varnothing 80 mm
 - CFS 3K-5, CFS 6K0.1: W×D 300×225 mm
- Net weight approx. 2,6 kg
- Connection cable approx.
 - A** - **E** 2,5 m
 - F** - **H** 5 m

Quantity platform KERN KFP-V20 IP65

- Weighing plate dimensions W×D×H, stainless steel
 - A** 230×230×110 mm
 - B** 300×240×110 mm
 - C** 400×300×125 mm
 - D** 500×400×137 mm
 - E** 650×500×135 mm

Quantity weighing bridge KERN KFP-V20 IP67

- Weighing plate dimensions W×D×H, Lacquered steel
 - F** 1000×1000×80 mm
 - G** 1500×1250×80 mm

Quantity pallet scale KERN KFU-V20

- Weighing plate dimensions W×D×H, Lacquered steel
 - H** 840×1300×90 mm



Accessories

- **Protective working cover**, scope of delivery: 5 items, KERN CFS-A02S05, **€ 40,-**
- **Rechargeable battery pack internal**, operating time up to 60 h without backlight, charging time approx. 12 h, KERN GAB-A04, **€ 40,-**
- **Signal lamp** for visual support of weighing with tolerance range, **Signal lamp** for visual support of weighing with tolerance range, KERN CFS-A03, **€ 250,-**
- Further details, plenty of further accessories and suitable printers see *Accessories*

Information on other high-capacity bulk balances, such as, for example, pallet scales, drive-through scales or floor scales is available on request, for information on other counting systems with the KERN CFS reference balance (d = 0.1 g), please refer to the website

STANDARD

CAL EXT MEMORY RS 232 DUAL PCS SUM TOL MULTI DMS 4 DAYS 5 DAYS

OPTION

ACCU DAKKS +3 DAYS

with [Max]> 600 kg

Model	Weighing capacity Quantity scale [Max] kg	Readability Quantity scale [d] g	Weighing plate	Weighing capacity Reference scale [Max] g	Readability Reference scale [d] g	Counting resolution Points	Smallest part weight [Normal] g/piece	Price excl. of VAT ex works €	Option	
									DAKKS KERN	€
CCS 6K-6	6	0,2	A	300	0,001	1.200.000	0,05	630,- ↓	962-128-127	145,-
CCS 10K-6	15	0,5	B	300	0,001	3.000.000	0,05	660,- ↓	962-128-127	145,-
CCS 30K0.01.	30	1	C	3000	0,01	600.000	0,5	540,- ↓	962-128-127	145,-
CCS 30K0.1.	30	1	C	6000	0,1	300.000	1	490,- ↓	962-128-128	175,-
CCS 60K0.01.	60	2	C	3000	0,01	1.200.000	0,5	540,- ↓	962-129-127	160,-
CCS 60K0.01L.	60	2	D	3000	0,01	1.200.000	0,5	620,- ↓	962-129-127	160,-
CCS 60K0.1.	60	2	C	6000	0,1	600.000	1	495,- ↓	962-129-128	175,-
CCS 60K0.1L.	60	2	D	6000	0,1	600.000	1	570,- ↓	962-129-128	175,-
CCS 150K0.01	150	5	D	3000	0,01	3.000.000	0,5	650,- ↓	962-129-127	160,-
CCS 150K0.01L	150	5	E	3000	0,01	3.000.000	0,5	860,- ↓	962-129-127	160,-
CCS 150K0.1.	150	5	D	6000	0,1	1.500.000	1	540,- ↓	962-129-128	175,-
CCS 150K0.1L	150	5	E	6000	0,1	1.500.000	1	820,- ↓	962-129-128	175,-
CCS 300K0.01	300	10	E	3000	0,01	6.000.000	0,5	860,- ↓	962-129-127	160,-
CCS 300K0.1	300	10	E	6000	0,1	3.000.000	1	780,- ↓	962-129-128	175,-
CCS 600K-2	600	200	F	3000	0,01	12.000.000	0,5	1540,- ↓	962-130-127	237,-
CCS 600K-2U	600	200	H	3000	0,01	12.000.000	0,5	1490,- ↓	962-130-127	237,-
CCS 1T-1L	1500	500	G	6000	0,1	15.000.000	1	1880,- ↓	962-130-128	253,-
CCS 1T-1U	1500	500	H	6000	0,1	15.000.000	1	1430,- ↓	962-130-128	253,-
CCS 3T-1	3000	1000	G	6000	0,1	30.000.000	1	1890,- ↓	962-132-128	528,-

↓ Price reduction



Parcel scales/Platform scales

Here you'll find a complete summary of the KERN platform scales series and their positioning within the platform scales segment on the basis of application, price-performance ratio and functional volume



Precision platform scales

		★★★★
		★★★
	DS	★





STAINLESS STEEL PLATFORM SCALES

		★★★★
▶ Page 107	 SXS	★★★
		★★
	SFB	★





PLATFORM SCALES WITH STAINLESS STEEL DISPLAY

		★★★★
	 IXS	★★★
	SFE	★

INDUSTRIAL PLATFORM SCALES

		★★★★
	 IOB	★★★
	 IFS	★★
	 IFT	★
	EOC	
	IFB	
	▶ Page 90	

PARCEL SCALES

		★★★★
	 EOB	★★★
	 EOS	★★
	EOE	★
	 DE	



Florian Bächle
Product specialist Platform scales

Tel. +49 7433 9933-118
Fax +49 7433 9933-29118
florian.baechle@kern-sohn.com

HIGHLIGHT



from €
270,-

- Robust and high-resolution platform scale
- Also available as a practical dual-range scale, high precision paired with large weighing capacities
- Protected against water splashes through IP65 rating

KERN EOC Page 102/103

Quick-Finder Parcel scales/Platform scales

Readability [d] g	Weighing range [Max] kg	Weighing plate W×D mm	Model KERN	Price excl. of VAT ex works €	Page		For an explanation on the pictos, see front flap											
							1	○		●		○	●	○	●	○	●	
20 50	60 150	650×500×142	IFB 150K20DLM	665,-	105	1		○		●		○	●					○
20 50	60 150	500×400×123	IXS 100K-2M	720,-	108	1		○		●		○	●					○
20 50	60 150	650×500×133,5	IXS 100K-2LM	790,-	108	1		○		●		○	●					○
50	150	305×315×55	EOE 100K-2	135,-	98	1				●								●
50	150	550×550×57	EOE 150K50L	270,-	98	1				●								●
50	150	950×500×60	EOE 150K50XL	310,-	98	1				●								●
50	150	315×305×55	EOB 150K50	152,-	99	1				●								●
50	150	550×550×75	EOB 150K50L	330,-	99	1				●								●
50	150	945×505×65	EOB 150K50XL	400,-	99	1				●								●
50	150	900×550×60	EOS 150K50XLF	510,-	99	1				●								●
50	150	400×300×130	SFE 100K-2NM	440,-	107	1		○		●			●					●
50	150	500×400×140	SFE 100K-2LNM	530,-	107	1		○		●			●					●
50	150	650×500×140	SFE 100K-2XLNM	650,-	107	1		○		●			●					●
50 100	150 300	522×403×83	DE 300K50D	315,-	100	1				●		○	●					○
50 100	150 300	650×500×89	DE 300K50DL	450,-	100	1				●		○	●					○
50 100	150 300	500×400×120	EOC 300K-2	330,-	102	1				●		○	●					○
50 100	150 300	600×500×150	EOC 300K-2L	470,-	102	1				●		○	●					○
50 100	150 300	650×500×150	IOC 300K-2M	650,-	104	1		○		●		○	●					○
50 100	150 300	650×500×142	IFB 300K50DM	665,-	105	1		○		●		○	●					○
50 100	150 300	650×500×133,5	IXS 300K-2M	790,-	108	1		○		●		○	●					○
50 100	150 300	650×500×142	IFT 300K-2LM	1190,-	112	2				●	○	○	●					○
100	300	305×315×55	EOE 300K100	135,-	98	1				●								●
100	300	550×550×57	EOE 300K100L	265,-	98	1				●								●
100	300	950×500×55	EOE 300K100XL	310,-	98	1				●								●
100	300	315×305×55	EOB 300K100A	152,-	99	1				●								●
100	300	550×550×75	EOB 300K100L	330,-	99	1				●								●
100	300	945×505×65	EOB 300K100XL	400,-	99	1				●								●
100	300	900×550×60	EOS 300K100XLF	510,-	99	1				●								●
100	300	650×500×140	SFE 300K-1LNM	650,-	107	1		○		●			●					●
100 200	300 600	800×600×200	IOC 600K-1M	850,-	104	1		○		●		○	●					○
100 200	300 600	800×600×200	IFB 600K-1M	920,-	105	2		○		●		○	●					○

● = standard ○ = option



Roller conveyor KERN YRO

Did you know?

For determining the weight of goods e.g. on conveyor in production or dispatch lines, we offer a selection of different roller conveyor attachments for our platform scales. In this way you can convert your platform scale into a robust measuring system for rapid and flexible weight determination. For all details on this, please see page 169.



Parcel scales with big platform for fast and easy weighing in the office, production, dispatch etc.

Features

- **High mobility:** thanks to battery operation, compact, lightweight construction, it is suitable for the use in several locations
- **Wall mount** for display device, standard
- **Hold function:** When the weighing conditions are unstable, a stable weight is calculated determining an average value
- **Protective working cover** over the display device, included with delivery

Technical data

- Large LCD display, digit height 25 mm
- Weighing plate dimensions, steel, painted W×D×H
 - A** 305×315×55 mm
 - B** 550×550×57 mm, see larger picture
 - C** 950×500×55 mm
- Dimensions of display device W×D×H 235×114×51 mm
- Optional battery operation, 4×1.5 V AA not included, operating time up to 100 h
- Permissible ambient temperature 5 °C/35 °C

Accessories

- **Protective working cover**, scope of delivery: 5 items, KERN EOB-A02S05, **€ 40,-**
- **Stand** to elevate display device, for models with weighing plate size **A**, height of stand approx. 480 mm, KERN EOB-A01N, **€ 50,-**
- **Stand** to elevate display device, height of stand approx. 950 mm, KERN EOB-A02B, **€ 70,-**
- **External universal mains adapter**, with universal input and optional input socket adapters for EU, GB, USA, KERN YKA-16, **€ 40,-**

11

STANDARD

CAL EXT UNIT MOVE BATT MULTI DMS 1 DAY

OPTION

DAKKS +3 DAYS

Model	Weighing capacity [Max] kg	Readability [d] g	Reproducibility g	Weighing plate	Net weight approx. kg	Cable length approx. m	Price excl. of VAT ex works €	Option	
								DAKKS KERN	DAKKS Calibr. Certificate €
KERN EOE 10K-3	15	5	5	A	4,0	1,8	135,-	963-128	88,-
EOE 30K-2	35	10	10	A	3,8	1,8	135,-	963-128	88,-
EOE 60K-2	60	20	20	A	3,8	1,8	135,-	963-129	105,-
EOE 60K-2L	60	20	20	B	13	2,7	270,-	963-129	105,-
EOE 100K-2	150	50	50	A	3,8	1,8	135,-	963-129	105,-
EOE 150K50L	150	50	50	B	13	2,7	270,-	963-129	105,-
EOE 150K50XL	150	50	50	C	18	2,7	310,-	963-129	105,-
EOE 300K100	300	100	100	A	3,6	1,8	135,-	963-129	105,-
EOE 300K100L	300	100	100	B	13	2,7	265,-	963-129	105,-
EOE 300K100XL	300	100	100	C	18	2,7	310,-	963-129	105,-

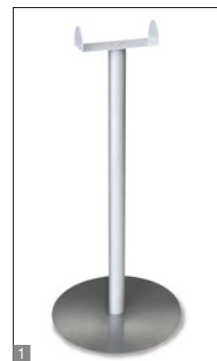

The bestsellers in parcel- and veterinary scales, also with XL-platform, and big weighing capacities

Features

- **Weighing plate stainless steel**, painted steel base
- **Simple and convenient 4-key operation**
- **Wall mount** for display device, standard
- **Hold function:** When the weighing conditions are unstable, a stable weight is calculated determining an average value
- KERN EOS: The scale can be easily transported using **rollers** and a **handle** and does not require much storage space
- **Protective working cover** over the display device included with delivery
- KERN EOS: **Non-slip rubber mat** included with delivery
- **External universal mains adapter** included with delivery

Technical data

- Large LCD display, digit height 25 mm
- Weighing plate dimensions, stainless steel W×D×H
 - A** 305×315×55 mm
 - B** 305×315×55 mm
 - C** 550×550×57 mm
 - D** 950×500×55 mm
- Dimensions of display device W×D×H 235×114×51 mm
- Cable length of display device approx. 1,8 m
- Optional battery operation, 4×1.5 V AA not included, operating time up to 60 h
- Permissible ambient temperature 5 °C/35 °C

Accessories

- **Protective working cover**, scope of delivery: 5 items, KERN EOB-A04BS05, **€ 40,-**
- **1 Stand** to elevate display device, height of stand approx. 950 mm, KERN EOB-A02B, **€ 70,-**
- **2 KERN EOB: Stand** to elevate display device, for models with weighing plate size **A**, height of stand approx. 450 mm, KERN EOB-A01N, **€ 50,-**
- **Non-slip rubber mat**
KERN EOB: W×D×H 945×505×5 mm, KERN EOE-A01, **€ 45,-**
KERN EOS: W×D×H 900×550×5 mm, KERN EOS-A01, **€ 35,-**

STANDARD

CAL EXT UNIT MOVE BATT MULTI DMS 1 DAY

OPTION

DAKKS +3 DAYS

Model	Weighing capacity [Max] kg	Readability [d] g	Reproducibility g	Linearity g	Net weight approx. kg	Weighing plate	Price excl. of VAT ex works €	Option	
								DAKKS KERN	DAKKS Calibr. Certificate €
KERN									
EOB 15K5	15	5	5	± 10	3,8	A	152,-	963-128	88,-
EOB 35K10	35	10	10	± 20	3,8	A	152,-	963-128	88,-
EOB 60K20	60	20	20	± 40	3,8	A	152,-	963-129	105,-
EOB 60K20L	60	20	20	± 40	12	B	330,-	963-129	105,-
EOB 150K50	150	50	50	± 100	3,8	A	152,-	963-129	105,-
EOB 150K50L	150	50	50	± 100	11	B	330,-	963-129	105,-
EOB 150K50XL	150	50	50	± 100	17	C	400,-	963-129	105,-
EOB 300K100A	300	100	100	± 200	3,8	A	152,-	963-129	105,-
EOB 300K100L	300	100	100	± 200	12	B	330,-	963-129	105,-
EOB 300K100XL	300	100	100	± 200	17	C	400,-	963-129	105,-
EOS 150K50XL	150	50	50	± 100	17	C	435,-	963-129	105,-
EOS 300K100XL	300	100	100	± 200	17	C	435,-	963-129	105,-

Price reduction



11

The long lasting story of success with dust and spray protected display device



Piece counting

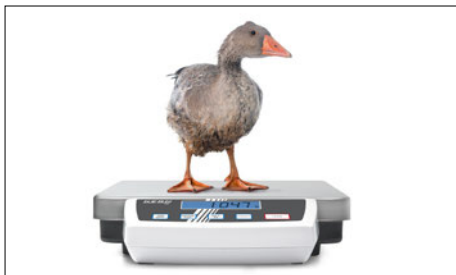

Animal weighing

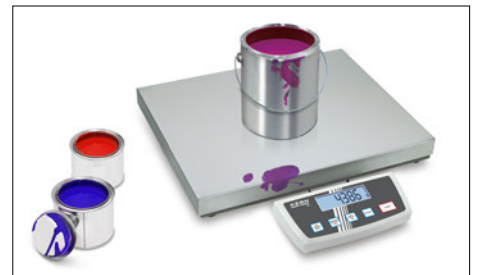

Recipe-weighing



Features

- **High mobility:** thanks to battery operation/ rechargeable battery operation (optional), compact, lightweight construction, it is suitable for the use in several locations (production, warehouse, dispatch department etc.)
- **Display device** flexible positioning, e.g. free-standing or mounted to the wall
- **Display device:** plastic, protection against dust and water splashes IP65
- **Weighing plate stainless steel**, painted steel base
- **PRE-TARE function** for manual subtraction of a known container weight, useful for checking fill-levels
- With the **recipe function** you can weigh the different ingredients of a mixture. As a check, you can also call up the total weight of all the ingredients
- **Freely programmable weighing unit**, e.g. display direct in special units such as length of thread g/m, paper weight g/m², or similar

- **Protective working cover** included with delivery

Technical data

- Large backlit LCD display, digit height 25 mm
- Weighing plate dimensions, stainless steel W×D×H
 - A 318×308×75 mm
 - B 318×308×88 mm
 - C 522×406×98 mm, see larger picture
 - D 522×403×83 mm
 - E 650×500×89 mm
- Dimensions of display device, W×D×H 225×110×45 mm
- Optional battery operation, 9 V block not included, operating time up to 12 h
- Permissible ambient temperature 5 °C/35 °C

Accessories

- **Protective working cover** over the display device, scope of delivery: 5 items, KERN DE-A12S05, € 40,-
- **Rechargeable battery pack internal**, operating time up to 30 h without backlight, charging time approx. 10 h, KERN NDE-A02, € 50,-
- **Mount to fasten the display device** to the platform, KERN DE-A11N, € 35,-
- **Wall mount** for display device, KERN DE-A13, € 30,-
- **Stand** to elevate display device, height of stand approx. 480 mm, KERN DE-A10, € 100,-
- **Individual header data:** the free software SHM-01 can be used to print header lines on the printout when using printers YKN-01 and YKB-01N
- Further details, plenty of further accessories and suitable printers see *Accessories*

STANDARD



OPTION



Model	Weighing capacity [Max] kg	Readability [d] g	Reproducibility g	Linearity g	Smallest part weight [Normal] g/piece	Cable length approx. m	Net weight approx. kg	Weighing plate	Price excl. of VAT ex works €	Option	
										DAkKS KERN	DAkKS Calibr. Certificate €
Dual-range balance switches automatically to the next largest weighing capacity [Max] and readability [d]											
DE 6K1D	3 6	1 2	1 2	± 3 6	40	-	4,8	A	185,-	963-128	88,-
DE 15K2D	6 15	2 5	2 5	± 6 15	100	-	4,8	A	185,-	963-128	88,-
DE 35K5D	15 35	5 10	5 10	± 15 30	100	-	4,8	A	185,-	963-128	88,-
DE 35K5DL	15 35	5 10	5 10	± 15 30	100	-	16	C	315,-	963-128	88,-
DE 60K10D	30 60	10 20	10 20	± 30 60	200	-	4,8	A	185,-	963-129	105,-
DE 60K10DL	30 60	10 20	10 20	± 30 60	200	-	16	C	315,-	963-129	105,-
DE 150K20D	60 150	20 50	20 50	± 60 150	400	-	5,0	A	195,-	963-129	105,-
DE 150K20DL	60 150	20 50	20 50	± 60 150	400	-	16	C	315,-	963-129	105,-
DE 150K20DXL	60 150	20 50	20 50	± 60 150	400	-	28	E	450,-	963-129	105,-
DE 300K50D	150 300	50 100	50 100	± 150 300	2000	-	16	C	315,-	963-129	105,-
DE 300K50DL	150 300	50 100	50 100	± 150 300	2000	-	28	E	450,-	963-129	105,-
Dual-range balance with high resolution readability											
DE 15K0.2D	6 15	0,2 0,5	0,2 0,5	± 0,8 2	4	-	4,0	B	335,-	963-128	88,-
DE 60K1D	30 60	1 2	1 2	± 4 8	20	-	7	B	335,-	963-129	105,-
DE 60K1DL	30 60	1 2	1 2	± 4 8	20	-	15	D	435,-	963-129	105,-
DE 150K2D	60 150	2 5	2 5	± 8 20	40	-	7	B	340,-	963-129	105,-
DE 150K2DL	60 150	2 5	2 5	± 8 20	40	-	15	D	435,-	963-129	105,-
DE 300K5DL	150 300	5 10	5 10	± 20 40	100	-	15	D	435,-	963-129	105,-



11

Robust and high-resolution platform scale with practical Flip/Flop display device for greatest ease of use



Weighing instead of counting!

Because the counting function is so easy to use, you can rapidly record large numbers of small parts – which saves time and money

Practical Flip/Flop display device: flexible positioning e.g. free-standing or screwed to the wall (optional). By rotating the upper housing shell you can determine the angle of the display as well as the cable outlet.

Factory Option ex works for an additional cost, delivery time + 2 working days, KERN KIB-M01, see Accessories on the right, please indicate when placing your order



Features

- **High mobility:** thanks to rechargeable battery operation (optional), compact, lightweight construction, it is suitable for the use in several locations (laboratory, production, quality control, commissioning etc.)
- **1 Platform:** weighing plate stainless steel, painted steel base, silicone-coated aluminium load cell, protection against dust and water splashes IP65. **Level indicator and levelling feet** for precise levelling of the scale, fitted as standard, to give the most accurate weighing result
- **Weighing with tolerance range (check-weighing):** a visual and audible signal helps with portioning, dispensing or grading
- **Hold function:** When the weighing conditions are unstable, a stable weight is calculated determining an average value
- **Benchtop stand incl. wall mount** for display device as standard
- **Protective working cover** included with delivery

- **Searching and remote control of the balance** using external control devices or computers with the KERN Communication Protocol (KCP). KCP is a standardised interface command structure for KERN balances and other instruments which allows you to recall and manage all relevant parameters and device functions. You can therefore simply connect KERN devices with KCP to computers, industrial control systems and other digital systems. In a large number of cases the KCP is compatible with the MT-SICS protocol. Only possible through data interface RS-232, other interfaces on request

Technical data

- Large backlit LCD display, digit height 24 mm
- Weighing plate dimensions W×D×H
 - A 300×300×110 mm
 - B 500×400×120 mm, see larger picture
 - C 600×500×150 mm
 - D 950×500×60 mm
- Dimensions of display device W×D×H 268×115×80 mm
- Permissible ambient temperature -10 °C/40 °C

Accessories

- **Protective working cover**, scope of delivery: 5 items, KERN EOC-A01S05, **€ 40,-**
- **Internal rechargeable battery pack**, operating time up to 43 h without backlight, charging time approx. 3 h, KERN KFB-A01, **€ 35,-**
- **Stand** to elevate display device, height of stand approx. 330 mm, KERN EOC-A05, **€ 60,-**
- **Mount to fasten the display device** to the platform, KERN EOC-A03, **€ 30,-**
- **Benchtop stand incl. wall mount** for display device, **Benchtop stand incl. wall mount** for display device, KERN EOC-A04, **€ 30,-**
- **Conversion of the display device**, to move the cable outlet to the front of the display device, ideal e.g. for subsequent wall installation of the display device (standard configuration ex works: rear outlet), Factory Option, delivery time + 2 working days, KERN KIB-M01, **€ 95,-**

STANDARD



OPTION



Model	Weighing capacity [Max] kg	Readability [d] g	Smallest part weight [Normal] g/piece	Cable length approx. m	Net weight approx. kg	Weighing plate	Price excl. of VAT ex works €	Option	
								DAkKS KERN	Calibr. Certificate €
KERN									
EOC 6K-3	3 6	1 2	2,5	3	6	A	270,-	963-128	88,-
EOC 10K-3	6 12	2 5	5	3	7	A	270,-	963-128	88,-
EOC 30K-3	15 35	5 10	10	3	6	A	270,-	963-128	88,-
EOC 30K-3L	15 35	5 10	10	3	9	B	330,-	963-128	88,-
EOC 60K-2	30 60	10 20	20	3	6	A	280,-	963-129	105,-
EOC 60K-2L	30 60	10 20	20	3	9	B	330,-	963-129	105,-
EOC 100K-2	60 150	20 50	50	3	6	A	280,-	963-129	105,-
EOC 100K-2L	60 150	20 50	50	3	9	B	330,-	963-129	105,-
EOC 100K-2XL	60 150	20 50	50	3	19	C	470,-	963-129	105,-
EOC 100K-2XXL	60 150	20 50	100	0,7 - 2,7	26	D	490,-	963-129	105,-
EOC 300K-2	150 300	50 100	100	3	9	B	330,-	963-129	105,-
EOC 300K-2L	150 300	50 100	100	3	19	C	470,-	963-129	105,-
Dual-range balance switches automatically to the next largest weighing capacity [Max] and readability [d]									
EOC 6K-4A	6	0,5	2,5	3	6	A	290,-	963-128	88,-
EOC 10K-3A	12	1	5	3	7	A	290,-	963-128	88,-
EOC 20K-3A	24	2	10	3	6	A	290,-	963-128	88,-
EOC 60K-3A	60	5	20	3	6	B	290,-	963-129	105,-
EOC 100K-2A	120	10	50	3	9	C	330,-	963-129	105,-
EOC 10K-4	6 15	0,2 0,5	5	3	7	A	310,-	963-128	88,-
EOC 30K-4	15 35	0,5 1	10	3	9	B	340,-	963-128	88,-
EOC 60K-3	30 60	1 2	20	3	6	A	310,-	963-129	105,-
EOC 60K-3L	30 60	1 2	20	3	9	B	340,-	963-129	105,-
EOC 100K-3	60 150	2 5	50	3	7	A	310,-	963-129	105,-
EOC 100K-3L	60 150	2 5	50	3	9	B	340,-	963-129	105,-
EOC 300K-3	150 300	5 10	100	3	9	B	340,-	963-129	105,-

Price reduction



Allround platform scale with a wide range of communication options and EC type approval [M]

Features

- **Industry 4.0:** A wide range of (optional) data interfaces allows that it is easy to transfer weighing data to tablets, laptops, PCs, networks, Smartphones, printers, etc.
- **High mobility:** thanks to rechargeable battery operation (optional), compact, lightweight construction, it is suitable for the use in several locations (laboratory, production, quality control, commissioning etc.)
- **Platform:** weighing plate stainless steel, painted steel base, silicone-coated aluminium load cell, protection against dust and water splashes IP65
- **Level indicator and levelling feet** for precise levelling of the scale, fitted as standard, to give the most accurate weighing result
- **Searching and remote control of the balance** using external control devices or computers with the KERN Communication Protocol (KCP). KCP is a standardised interface command structure for KERN balances and other instruments which allows you to recall and manage all relevant parameters and device functions. You can therefore simply connect

KERN devices with KCP to computers, industrial control systems and other digital systems. In a large number of cases the KCP is compatible with the MT-SICS protocol. Only possible through data interface RS-232, other interfaces on request

Technical data

- Large backlit LCD display, digit height 24 mm
- Weighing plate dimensions W×D×H
 - A 300×300×110 mm
 - B 400×300×110 mm
 - C 500×400×120 mm
 - D 650×500×150 mm
 - E 800×600×200 mm
- Dimensions of display device W×D×H 260×115×70 mm
- Cable length of display device approx. 3 m
- Permissible ambient temperature -10 °C/40 °C

Accessories

- **Protective working cover**, scope of delivery: 5 items, KERN EOC-A01S05, **€ 40,-**
- **Stand** to elevate display device, height of stand approx. 330 mm, KERN EOC-A05, **€ 60,-**

- **Mount to fasten the display device** to the platform, KERN EOC-A03, **€ 30,-**
- **Benchtop stand incl. wall mount** for display device, **Benchtop stand incl. wall mount** for display device, KERN EOC-A04, **€ 30,-**
- **Rechargeable battery pack internal**, operating time up to 26 h with backlight, charging time approx. 3 h, KERN KFB-A01, **€ 35,-**
- **USB data interface**, must be ordered at purchase, KERN KIB-A03, **€ 120,-**
- **Bluetooth data interface**, must be ordered at purchase, KERN KIB-A04, **€ 110,-**
- **WiFi interface** must be ordered at purchase, please ask for delivery time, KERN KIB-A10, **€ 55,-**
- **Ethernet data interface**, to connect an IP-based Ethernet network, must be ordered at purchase, not in combination with KERN KIB-A03, KIB-A04, KIB-A10. KERN KIB-A02, **€ 150,-**
- **Signal lamp, including interface**, for visual support of weighing with tolerance range, KERN KIB-A06, **€ 320,-**
- **Conversion of the display device**, to move the cable outlet to the front of the display device, ideal e.g. for subsequent wall installation of the display device (standard configuration ex works: rear outlet), Factory Option, delivery time + 2 working days, KERN KIB-M01, **€ 95,-**

STANDARD



OPTION



FACTORY



Model	Weighing capacity [Max] kg	Readability [d] g	Verification value [e] g	Minimal load [Min] g	Weighing plate	Price excl. of VAT ex works €	Option			
							Verification		DAkkS Calibr. Certificate	
							M	€	DAkkS KERN	€
KERN IOC 6K-3M	3 6	1 2	1 2	20 40	A	320,-	965-228	70,-	963-128	88,-
KERN IOC 10K-3M	6 15	2 5	2 5	40 100	A	295,-	965-228	70,-	963-128	88,-
KERN IOC 10K-3LM	6 15	2 5	2 5	40 100	B	360,-	965-228	70,-	963-128	88,-
KERN IOC 30K-3M	15 30	5 10	5 10	100 200	B	360,-	965-228	70,-	963-128	88,-
KERN IOC 60K-2M	30 60	10 20	10 20	200 400	B	370,-	965-229	93,-	963-129	105,-
KERN IOC 60K-2LM	30 60	10 20	10 20	200 400	C	465,-	965-229	93,-	963-129	105,-
KERN IOC 100K-2M	60 150	20 50	20 50	400 1000	C	465,-	965-229	93,-	963-129	105,-
KERN IOC 100K-2LM	60 150	20 50	20 50	400 1000	D	625,-	965-229	93,-	963-129	105,-
KERN IOC 300K-2M	150 300	50 100	50 100	1000 2000	D	650,-	965-229	93,-	963-129	105,-
KERN IOC 600K-1M	300 600	100 200	100 200	2000 4000	E	850,-	965-230	132,-	963-130	165,-

* Verification not in combination with KERN KIB-A02, KIB-A03, KIB-A04, KIB-A10



Accessories

- **Protective working cover**, scope of delivery: 5 items, KERN KFB-A02S05, **€ 40,-**
- **Stand** to elevate display device, for models with weighing plate size
 - A**, **Q**: Height of stand approx. 330 mm, KERN IFB-A01, **€ 50,-**
 - D** - **F**: **2** Height of stand approx. 600 mm, KERN IFB-A02, **€ 60,-**
 - A** - **F**: Height of stand approx. 800 mm, **Stand** to elevate display device, height of stand approx. 800 mm, KERN BFS-A07, **€ 120,-**
- **Rechargeable battery pack internal**, operating time up to 35 h, without backlight, charging time approx. 12 h, must be ordered at purchase, KERN KFB-A01, **€ 35,-**
- **Bluetooth data interface** for wireless data transfer to PC or tablets, must be ordered at purchase, not in combination with verification, KERN KFB-A03, **€ 130,-**
- Analogue module, must be ordered at purchase, not possible in combination with signal lamp 0-10 V: KERN KFB-A04, **€ 95,-**
4-20 mA: KERN KFB-A05, **€ 95,-**
- **Signal lamp** KERN CFS-A03, **€ 250,-**
- **Y-cable** for parallel connection of two terminal devices to the RS-232 interface on the scale, KERN CFS-A04, **€ 35,-**

High-resolution industrial scale in heavy version with EC type approval [M], now also up to [Max] 600 kg

Features

- **Tough industry standard** suitable for use in harsh industrial applications
- **1 Platform:** weighing plate stainless steel, painted steel base, silicone-coated aluminium load cell, protection against dust and water splashes IP65
- **Benchtop stand incl. wall mount** for display device as standard
- **Protective working cover** included with delivery

Technical data

- Large backlit LCD display, digit height 52 mm
- Weighing plate dimensions, stainless steel W×D×H
 - A** 230×230×110 mm, **B** 300×240×110 mm
 - C** 400×300×128 mm, **D** 500×400×130 mm
 - E** 650×500×142 mm, **F** 800×600×200 mm
- Dimensions of display device W×D×H 230×230×360 mm
- Cable length of display device approx. 3 m
- Permissible ambient temperature -10 °C/40 °C

STANDARD

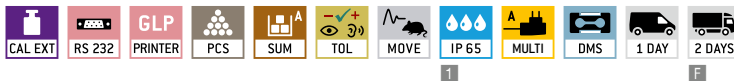

OPTION FACTORY



Model	Weighing capacity [Max] kg	Readability [d] g	Verification value [e] g	Minimal load [Min] g	Net weight approx. kg	Weighing plate	Price excl. of VAT ex works €	Option			
								Verification		DAkkS Calibr. Certificate	
KERN								M	€	DAkkS	€
IFB 3K-4	3	0,1	-	-	6	A	350,-	-	-	963-127	72,-
IFB 6K-4S	6	0,2	-	-	6	A	320,-	-	-	963-128	88,-
IFB 6K-4	6	0,2	-	-	6	B	350,-	-	-	963-128	88,-
IFB 10K-4	15	0,5	-	-	6	B	320,-	-	-	963-128	88,-
IFB 10K-4L	15	0,5	-	-	10	C	390,-	-	-	963-128	88,-
IFB 30K-3	30	1	-	-	10	C	390,-	-	-	963-128	88,-
IFB 60K-3	60	2	-	-	10	C	390,-	-	-	963-129	105,-
IFB 60K-3L	60	2	-	-	14	D	490,-	-	-	963-129	105,-
IFB 100K-3	150	5	-	-	11	D	490,-	-	-	963-129	105,-
IFB 100K-3L	150	5	-	-	20	E	690,-	-	-	963-129	105,-
IFB 300K-2	300	10	-	-	20	E	690,-	-	-	963-129	105,-
IFB 600K-2	600	20	-	-	65	F	790,-	-	-	963-130	165,-
Dual-range balance switches automatically to the next largest weighing capacity [Max] and readability [d]											
IFB 6K-3SM	3 6	1 2	1 2	20 40	4,6	A	350,-	965-228	70,-	963-128	88,-
IFB 6K1DM	3 6	1 2	1 2	20 40	6	A	335,-	965-228	70,-	963-128	88,-
IFB 15K2DM	6 15	2 5	2 5	40 100	6	B	335,-	965-228	70,-	963-128	88,-
IFB 15K2DLM	6 15	2 5	2 5	40 100	10	C	400,-	965-228	70,-	963-128	88,-
IFB 30K5DM	15 30	5 10	5 10	100 200	10	C	400,-	965-228	70,-	963-128	88,-
IFB 60K10DM	30 60	10 20	10 20	200 400	10	C	410,-	965-229	93,-	963-129	105,-
IFB 60K10DLM	30 60	10 20	10 20	200 400	13	D	505,-	965-229	93,-	963-129	105,-
IFB 150K20DM	60 150	20 50	20 50	400 1000	14	D	490,-	965-229	93,-	963-129	105,-
IFB 150K20DLM	60 150	20 50	20 50	400 1000	20	E	665,-	965-229	93,-	963-129	105,-
IFB 300K50DM	150 300	50 100	50 100	1000 2000	22	E	665,-	965-229	93,-	963-129	105,-
IFB 600K-1M	300 600	100 200	100 200	2000 4000	65	F	920,-	965-230	132,-	963-130	165,-

Note: For applications that require verification, please order verification at the same time, initial verification at a later date is not possible. Verification at the factory, we need to know the full address of the location of use.

Price reduction



Precision industrial scale with laboratory accuracy

Features

- **High-capacity precision balance**, ideal for high volume or heavy samples to be weighed with a high degree of accuracy
- **User guidance step by step** on display by Yes/No dialogue
- Numerical subtraction of tare weight for known container weight. Useful for checking fill-levels
- **Precise counting**: The automatic reference weight optimisation of reference weight gradually improves the average piece weight value
- KERN DS: **Freely programmable weighing unit**, e.g. display direct in special units such as length of wire g/m, surface weight g/m², or else
- **Protective working cover** included with delivery

Technical data

- Large backlit LCD display, digit height 18 mm
- Weighing plate dimensions, stainless steel W×D×H
 - A 228×228×95 mm
 - B 308×318×75 mm, see larger picture
 - C 450×350×115 mm
- Dimensions of display device W×D×H 225×115×60 mm
- Cable length of display device approx.
 - A, B 2 m
 - C 0,6 m
- Permissible ambient temperature 10 °C/40 °C

Accessories

- **Protective working cover** over the display device, scope of delivery: 5 items, KERN DE-A12S05, **€ 40,-**
- **1 Stand** to elevate display device, for models with weighing plate size B, C, height of stand approx. 480 mm, KERN DE-A10, **€ 100,-**
- **Mount to fasten the display device to the platform**, for models with weighing plate size B, C, can be reordered, KERN DE-A11N, **€ 35,-**
- **Wall mount** for display device, KERN DS-A02, **€ 30,-**
- **2 Set for underfloor weighing**, consists of platform, bow, hook, only for models with weighing plate B, KERN DS-A01, **€ 200,-**
- **Rechargeable battery pack external**, operating time up to 30 h without backlight, charging time approx. 10 h, KERN KS-A01, **€ 160,-**
- **Rechargeable battery pack internal**, operating time up to 30 h without backlight, charging time approx. 10 h, KERN KB-A01N, **€ 50,-**
- Further details, plenty of further accessories and suitable printers see *Accessories*

STANDARD

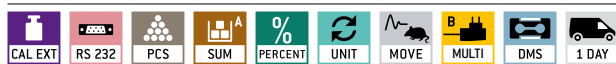

OPTION



Model	Weighing capacity [Max] kg	Readability [d] g	Smallest part weight [Normal] g/piece	Net weight approx. kg	Weighing plate	Price excl. of VAT ex works €	Option	
							DAKkS KERN	DAKkS Calibr. Certificate €
DS 3K0.01S	3	0,01	0,1	4,2	A	640,-	963-127	72,-
DS 5K0.05S	5	0,05	0,5	4,2	A	560,-	963-127	72,-
DS 8K0.05	8	0,05	0,5	8	B	550,-	963-128	88,-
DS 10K0.1S	10	0,1	1	4,2	A	530,-	963-128	88,-
DS 16K0.1	16	0,1	1	9	B	550,-	963-128	88,-
DS 20K0.1	20	0,1	1	8	B	580,-	963-128	88,-
DS 30K0.1	30	0,1	1	8	B	610,-	963-128	88,-
DS 30K0.1L	30	0,1	1	10	C	720,-	963-128	88,-
DS 36K0.2	36	0,2	2	8	B	550,-	963-128	88,-
DS 36K0.2L	36	0,2	2	10	C	660,-	963-128	88,-
DS 60K0.2	60	0,2	2	10	C	740,-	963-129	105,-
DS 65K0.5	65	0,5	5	10	C	700,-	963-129	105,-
DS 100K0.5	100	0,5	5	10	C	740,-	963-129	105,-
DS 150K1	150	1	10	10	C	740,-	963-129	105,-



Platform scale with dust and spray protection IP65 and EC type approval [M]

Features

- Platform scale protected to IP65 with stainless steel display device, for industrial applications, hygienic and easy to clean
- 1 Platform:** weighing plate stainless steel, painted steel base, silicone-coated aluminium load cell, protection against dust and water splashes IP65
- Display device:** stainless steel, protection against dust and water splashes IP65, flexible positioning, e.g. free-standing or mounted to the wall, for details see KERN KFE-TNM
- Weighing with tolerance range (check-weighing):** a visual and audible signal helps with portioning, dispensing or grading
- Hold function:** When the weighing conditions are unstable, a stable weight is calculated determining an average value

Technical data

- Large backlit LCD display, digit height 22 mm
- Weighing plate dimensions, stainless steel W×D×H
 - A** 300×240×110 mm, see larger picture
 - B** 400×300×130 mm
 - C** 500×400×140 mm
 - D** 650×500×140 mm
- Dimensions of display device W×D×H 195×118×83 mm
- Cable length of display device approx. 3 m
- Rechargeable battery pack internal, operating time up to 35 h without backlight, charging time approx. 12 h
- Permissible ambient temperature -10 °C/40 °C

Accessories

- 2 Stand** to elevate display device, for models with weighing plate size
 - A-D:** Height of stand approx. 200 mm, KERN SFE-A01, **€ 55,-**
 - B-D:** Height of stand approx. 400 mm, KERN SFE-A02, **€ 55,-**
 - C-D:** Height of stand approx. 600 mm, KERN SFE-A03, **€ 65,-**
- Tare pan made of stainless steel**, ideal for weighing loose small parts, fruit, vegetables etc., W×D×H 370×240×20 mm, KERN RFS-A02, **€ 55,-**

STANDARD



OPTION



FACTORY



Model	Weighing capacity [Max] kg	Readability [d] g	Verification value [e] g	Minimal load [Min] g	Net weight approx. kg	Weighing plate	Price excl. of VAT ex works €	Option			
								Verification		DAkkS Calibr. Certificate	
								M III KERN	€	DAkkS KERN	€
SFE 6K-3NM	6	2	2	40	6	A	380,-	965-228	70,-	963-128	88,-
SFE 10K-3NM	15	5	5	100	6	A	370,-	965-228	70,-	963-128	88,-
SFE 10K-3LNM	15	5	5	100	10	B	430,-	965-228	70,-	963-128	88,-
SFE 30K-2NM	30	10	10	200	6	A	370,-	965-228	70,-	963-128	88,-
SFE 60K-2NM	60	20	20	400	10	B	420,-	965-229	93,-	963-129	105,-
SFE 60K-2LNM	60	20	20	400	14	C	530,-	965-229	93,-	963-129	105,-
SFE 100K-2NM	150	50	50	1000	10	B	440,-	965-229	93,-	963-129	105,-
SFE 100K-2LNM	150	50	50	1000	14	C	530,-	965-229	93,-	963-129	105,-
SFE 100K-2XLNM	150	50	50	1000	22	D	650,-	965-229	93,-	963-129	105,-
SFE 300K-1LNM	300	100	100	2000	20	D	650,-	965-229	93,-	963-129	105,-

Note: For applications that require verification, please order verification at the same time, initial verification at a later date is not possible. Verification at the factory, we need to know the full address of the location of use.

Price reduction



11

Platform scale with stainless steel display device with IP68 rating, XL-display und EC type approval [M] – now also as high resolution version with high-resolution display



Piece-counting function



Durable stainless steel weighing plate



Stainless steel display device with IP68 protection, hygienic and easy to clean

Platform scale with stainless steel display device KERN IXS



Features

- **Tough industry standard** suitable for use in harsh industrial applications
- **1 Platform:** weighing plate stainless steel, painted steel base, silicone-coated aluminium load cell, protection against dust and water splashes IP65, Substruction in wing design, extremely resistant to bending
- **Superior display size:** digit height 55 mm, bright backlight for easy reading of weighing results, even in poor lighting conditions
- **2 Display device:** stainless steel, protection against dust and water splashes IP68, integrated power supply
- **ESD drain to protect against electrostatic discharge** e.g. for electrostatically-charged weighing objects or people who work with the scale
- Thanks to **interfaces** such as RS-232, RS-485 and Bluetooth (optional) the scale can easily be connected to existing networks and facilitates the data exchange between the scale and printer

Technical data

- Large backlit LCD display, digit height 55 mm
- Weighing plate dimensions, stainless steel W×D×H
 - A** 300×240×86 mm
 - B** 400×300×89 mm
 - C** 500×400×123 mm
 - D** 650×500×133,5 mm
- Dimensions of display device W×D×H 232×170×80 mm
- Cable length of display device approx. 2,5 m
- Permissible ambient temperature -10 °C/40 °C

Accessories

- **3 Stand** to elevate display device
 - A-D** Height of stand approx. 50 mm, KERN IXS-A01, **€ 55,-**
 - A-D** Height of stand approx. 200 mm, KERN IXS-A02, **€ 70,-**
 - B-D** Height of stand approx. 400 mm, KERN IXS-A03, **€ 75,-**
 - C-D** Height of stand approx. 600 mm, KERN IXS-A04, **€ 85,-**

- **Rechargeable battery pack internal**, operating time up to 80 h without backlight, charging time approx. 12 h, KERN GAB-A04, **€ 40,-**
- **Data interface RS-232**, interface cable included, approx. 1,5 m, must be ordered at purchase, KERN KXS-A04, **€ 100,-**
- **Data interface RS-485**, must be ordered at purchase, KERN KXS-A01, **€ 145,-**
- **Bluetooth data interface** for wireless data transfer to PC or tablets, must be ordered at purchase, not in combination with verification, KERN KXS-A02, **€ 170,-**
- **Foot switch**, must be ordered at purchase, KERN KXS-A03, **€ 130,-**
- **Roller conveyor attachment**, with smooth-running, hot-dip galvanised steel rollers with ball bearings, robust aluminium profile frame, KERN YRO-01, **€ 660,-**
- Further details, plenty of further accessories and suitable printers see *Accessories*

STANDARD



OPTION



FACTORY

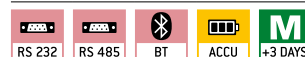

Model	Weighing range [Max] kg	Readability [d] g	Verification value [e] g	Minimal load [Min] g	Net weight approx. kg	Weighing plate	Price excl. of VAT ex works €	Option			
								Verification		DAkkS Calibr. Certificate	
KERN								M III KERN	€	DAkkS KERN	€
IXS 6K-4	6	0,2	-	-	6	A	520,-	-	-	963-128	88,-
IXS 10K-4	15	0,5	-	-	6	A	520,-	-	-	963-128	88,-
IXS 10K-4L	15	0,5	-	-	11	B	590,-	-	-	963-128	88,-
IXS 30K-3	30	1	-	-	11	B	590,-	-	-	963-128	88,-
IXS 30K-3L	30	1	-	-	22	C	720,-	-	-	963-128	88,-
IXS 60K-3	60	2	-	-	11	B	590,-	-	-	963-129	105,-
IXS 60K-3L	60	2	-	-	22	C	720,-	-	-	963-129	105,-
IXS 100K-3	150	5	-	-	22	C	720,-	-	-	963-129	105,-
IXS 100K-3L	150	5	-	-	36	D	790,-	-	-	963-129	105,-
IXS 300K-2	300	10	-	-	36	D	790,-	-	-	963-129	105,-
Dual-range balance switches automatically to the next largest weighing capacity [Max] and readability [d]											
IXS 6K-3M	3 6	1 2	1 2	20 40	6	A	520,-	965-228	70,-	963-128	88,-
IXS 10K-3M	6 15	2 5	2 5	40 100	6	A	520,-	965-228	70,-	963-128	88,-
IXS 10K-3LM	6 15	2 5	2 5	40 100	11	B	590,-	965-228	70,-	963-128	88,-
IXS 30K-2M	15 30	5 10	5 10	100 200	11	C	590,-	965-228	70,-	963-128	88,-
IXS 30K-2LM	15 30	5 10	5 10	100 200	22	C	720,-	965-228	70,-	963-128	88,-
IXS 60K-2M	30 60	10 20	10 20	200 400	11	B	590,-	965-229	93,-	963-129	105,-
IXS 60K-2LM	30 60	10 20	10 20	200 400	22	C	720,-	965-229	93,-	963-129	105,-
IXS 100K-2M	60 150	20 50	20 50	400 1000	22	C	720,-	965-229	93,-	963-129	105,-
IXS 100K-2LM	60 150	20 50	20 50	400 1000	36	D	790,-	965-229	93,-	963-129	105,-
IXS 300K-2M	150 300	50 100	50 100	1000 2000	36	D	790,-	965-229	93,-	963-129	105,-

Note: For applications that require verification, please order verification at the same time, initial verification at a later date is not possible. Verification at the factory, we need to know the full address of the location of use.

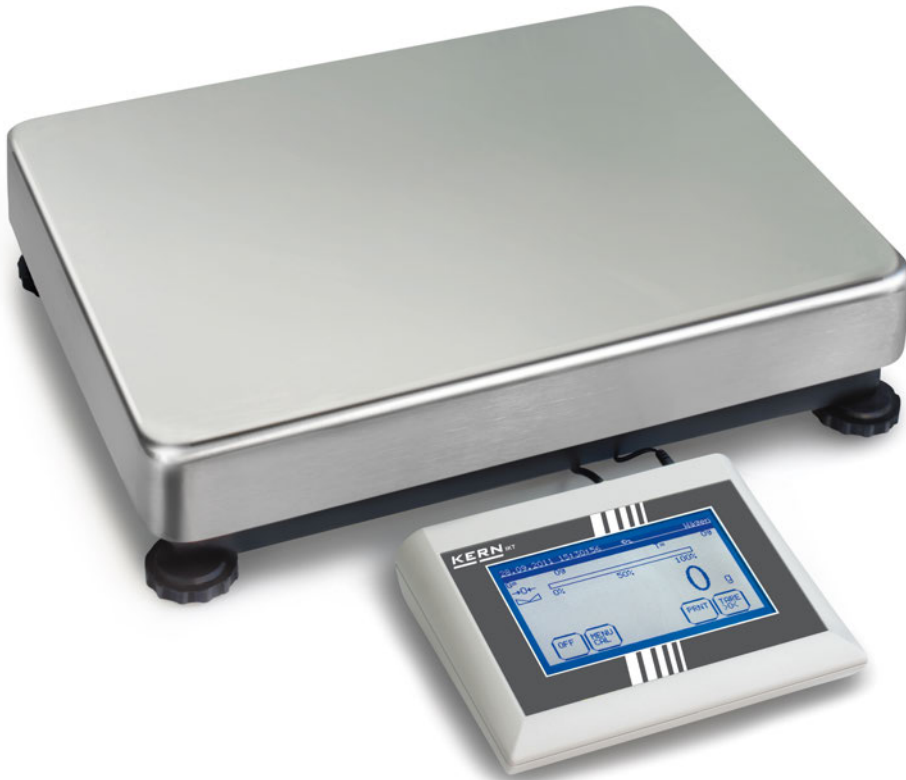

Alibi memory

- Ring memory for up to 49,152 measuring results (744 measuring results per day!)
- Saved measuring results cannot be changed or cleared. If the maximum memory capacity is reached, then the oldest value will be overwritten
- In addition to the measuring result, the date, time, tare value, a sequential number and the serial number of the balance are also saved.
- Saved measuring results can be searched and recalled easily
- The alibi memory can also be used for applications which do not require verification
- Complies with WELMEC 2.5



11

Touchscreen platform scale with enormous range of functions



Easy input of text and values
Using large keypad, e.g. up to 80 item descriptions, user name, packaging weights for tare containers etc.

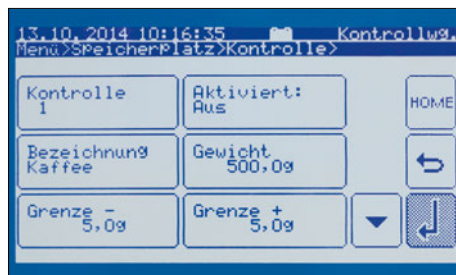

80 memories for each mode
e.g. for Checkweighing, PRE-TARE, reference weight, target value when dispensing, item descriptions, user name, weights for tare containers, etc. Easy to enter using the large-scale keypad

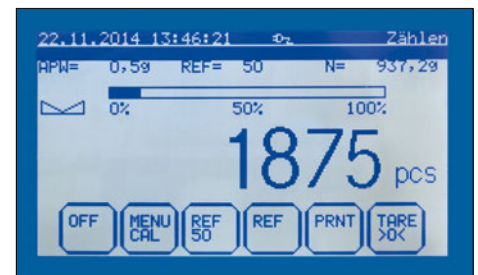

Professional counting function
All relevant counting information at a glance, such as, e.g., reference weight, reference quantity, total count, total weight, tare container weight, available weighing capacity and much more

Features

- **Convenient recipe weighing:** 99 recipes with 10 components each can be stored in plain text. There is a function to adjust the other components if the initial weight was too high. The actual values and the desired values well as the proportionate percentages can be printed afterwards.
- **Multiplier function:** recipes with the ingredient weights recorded as percentage values can easily be replicated by entering a new target weight. The ideal solution for the preparation of larger containers, bulk packs etc.
- **Rapid function** for shortened stabilisation time with reduced readout
- **Control outputs (optocoupler, digital I/O)** to connect relays, signal lamps, valves etc. (35V/80mA)

Technical data

- Large backlit LCD touch display, digit height 18 mm, screen diagonal 5,8" (127×74 mm)
- Weighing plate dimensions, stainless steel W×D×H
 - A 228×228×95 mm
 - B 315×308×75 mm
 - C 450×350×115 mm
 - D 650×500×142 mm
- Dimensions of display device W×D×H 200×155×68 mm
- Cable length of display device approx., for models with weighing plate size
 - A 1 m
 - B, D 2 m
 - C 0,6 m
- Permissible ambient temperature 10 °C/40 °C

Accessories

- **Rechargeable battery pack external**, operating time up to 20 h without backlight, charging time approx. 10 h, KERN KS-A01, **€ 160,-**
- **Signal lamp** for visual support of weighing with tolerance range, KERN IKT-A04, **€ 260,-**
- **RS-232/Ethernet adapter** for connection to an IP-based Ethernet network, KERN YKI-01, **€ 290,-**
- **RS-232/USB adapter**, to connect peripheral devices with USB connection, KERN AFH 12, **€ 85,-**
- **Set for underfloor weighing**, consists of platform, bow, hook, only for models with weighing plate B, KERN DS-A01, **€ 200,-**
- **Stand** to elevate display device, for models with weighing plate size B, C, height of stand approx. 480 mm, KERN IKT-A06, **€ 105,-**
- **Wall mount** for display device, KERN IKT-A03, **€ 35,-**
- **Suitable printers** see *Accessories*

Modes

- ① Weighing
- ② Counting
- ③ Dispensing
- ④ Recipe weighing
- ⑤ Checkweighing
- ⑥ Totalising with daily total
- ⑦ Percentage determination
- ⑧ Animal weighing
- ⑨ Surface weight
- ⑩ Density determination, only with B
- ⑪ Rapid function

Functions

- Capacity display with ①, ②, ⑤-⑦, ⑨-⑩
- Dispensing aid (-/+), with ③, ④
- Net/gross display, permanent, with ①, ③-⑤, ⑧-⑪
- Variable reference quantity, with ②
- Automatic reference optimisation, with ②
- PRE-TARE numerical or from the memory unit, with ①-⑦, ⑪
- Entering of item or batch description, operator etc., with ①-⑦, ⑪
- Freely programmable weighing unit, e.g. display direct in special units such as length of thread g/m, grammage g/m², or similar, with ⑨
- Date/time, with ①-⑪
- Statistical function, with ①
- GLP printout, with ①-⑪
- Individual formatting of up to 16 printer forms, recipes, operating mode master data in MS Excel, import via RS-232, for examples, see the internet, with ①-⑪

STANDARD



OPTION



Model	Weighing capacity [Max] kg	Readability [d] g	Smallest part weight [Normal] g/piece	Net weight approx. kg	Weighing plate	Price excl. of VAT ex works €	Option	
							DAKKS KERN	DAKKS Calibr. Certificate €
KERN								
IKT 6K0.1	6	0,1	1	8	B	830,-	963-128	88,-
IKT 12K0.2*	12	0,2	2	8	B	830,-	963-128	88,-
IKT 30K0.5	30	0,5	5	8	B	830,-	963-128	88,-
IKT 60K1L	60	1	10	10	C	1050,-	963-129	105,-
IKT 120K2L*	120	2	20	10	C	1050,-	963-129	105,-
IKT 150K2XL	150	2	20	20	C	1200,-	963-129	105,-
IKT 300K5XL	300	5	50	20	D	1200,-	963-129	105,-
IKT 3K0.01S	3	0,01	0,1	6	A	920,-	963-127	72,-
IKT 8K0.05	8	0,05	0,5	8	B	850,-	963-128	88,-
IKT 16K0.1	16	0,1	1	8	B	850,-	963-128	88,-
IKT 30K0.1	30	0,1	1	8	B	850,-	963-128	88,-
IKT 30K0.1L	30	0,1	1	10	C	1150,-	963-128	88,-
IKT 36K0.2*	36	0,2	2	8	B	850,-	963-128	88,-
IKT 36K0.2L	36	0,2	2	10	C	1050,-	963-128	88,-
IKT 60K0.2L	60	0,2	2	10	C	1120,-	963-129	105,-
IKT 65K0.5L	65	0,5	5	10	C	1050,-	963-129	105,-
IKT 100K0.5L	100	0,5	5	10	C	1150,-	963-129	105,-
IKT 150K1L	150	1	10	10	C	1150,-	963-129	105,-

*ONLY WHILE STOCKS LAST



11

KERN easytouch platform scale – the intuitive way to weight – now also as high resolution version with high-resolution display

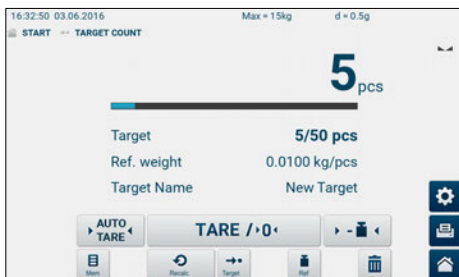

Convenient piece-counting function

Standard use: Direct input of the reference quantity or the reference weight
 Professional use: Recall of items to be counted from the database with all relevant additional data such as piece weight, name, reference quantity, tare container weight, tolerances. Which means a super-fast sequence when counting: select item – load – count – done!

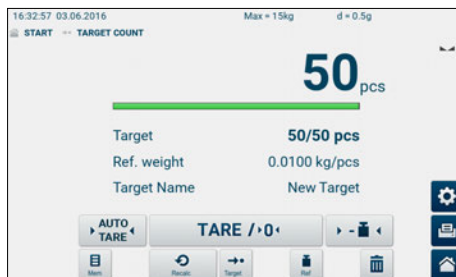

Fill-to-target function

Programmable target quantity or target weight. A signal will be displayed when the target value is reached

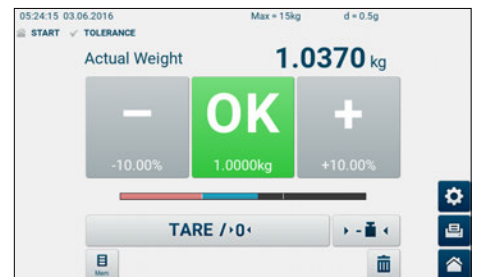

Convenient weighing with tolerance range (Checkweighing)

Standard use: Direct input of the tolerances in grams or percent
 Professional use: Recall of items from the database with all relevant additional data such as piece weight, name, reference quantity, tare container weight, tolerances. That leads to a super-fast sequence when portioning, dosing or sorting: Select item – load – check – done!



Features

- **High-quality, rapid processors** allow efficient, delay-free operation
- Thanks to the **intuitive touchscreen concept** and multi-lingual operation (DE, GB, FR, IT, ES, PT, NL, FI, PL, RUS, SE, CZ) the balance can be used easily by inexperienced users, straightaway. For the professional user, the balance provides convenient functions which permit a high level of individualisation and which thereby make operation significantly easier and quicker.
- Through a **large memory (256 MB)**, e.g. for item master data, weighing data etc. the balance is the ideal solution when working with a large range of goods or where there are high requirements for record keeping and documentation
- **1** Thanks to the high level of **connectivity** it is easy to connect USB sticks for data storage or data transfer to PCs, scales and networks using RS-232 or USB. This means that this range can be used for many different functions in Industry 4.0 applications
- **Convenient recipe weighing**
Standard use: Direct input of the recipe ingredients in grams or percent Professional use: Recall of items from the database with all relevant additional data such as target value, tolerances, name, tare container weight. That leads to a super-fast sequence when recipe-weighing:
select recipe – weigh – done!

- A graphic signal helps when dosing individual recipe ingredients. An information column on the lefthand edge of the screen allows you to see at a glance which ingredients have already been weighed (proportionately).
- **Multiplier function:** recipes and their ingredients can be multiplied at will at the press of a button, which is ideal for the production of larger containers, bulk packs etc.
- **2 Platform:** weighing plate stainless steel, painted steel base, silicone-coated aluminium load cell, protection against dust and water splashes IP65

Technical data

- Large backlit LCD touch display, digit height 12 mm, screen diagonal 7" (155×85 mm)
- Weighing plate dimensions W×D×H, stainless steel
 - A** 300×240×100 mm
 - B** 400×300×128 mm, see larger picture
 - C** 500×400×137 mm
 - D** 650×500×142 mm
- Dimensions of display device, W×D×H 252×152×133 mm
- Cable length of display device approx. 3 m
- Permissible ambient temperature -10 °C/40 °C

Accessories

- **Stand** to elevate display device, height of stand approx. 330 mm, KERN IFB-A01, **€ 50,-**
- **Stand** to elevate display device, height of stand approx. 600 mm, KERN IFB-A02, **€ 60,-**
- **Stand** to elevate display device, height of stand approx. 800 mm, KERN BFS-A07, **€ 120,-**
- **Rechargeable battery pack internal**, operating time up to 7 h with backlight, charging time approx. 12 h, KERN KFB-A01, **€ 35,-**
- **Y-cable** for parallel connection of two terminal devices to the RS-232 interface on the scale, e.g. signal lamp or barcode reader and printer, KERN CFS-A04, **€ 35,-**
- **Software** for rapid and easy processing of the database at the PC (exporting, processing, importing), KERN SET-1.0, **€ 150,-**

STANDARD



OPTION



Model	Weighing capacity [Max] kg	Readability [d] g	Reproducibility g	Linearity g	Net weight approx. kg	Weighing plate	Price excl. of VAT ex works €	Option	
								DAkKS Calibr. Certificate	
								DAkKS KERN	€
IFT 6K-4	6	0,2	0,2	0,6	6	A	850,- ↓	963-128	88,-
IFT 10K-4	15	0,5	0,5	1,5	6	A	850,- ↓	963-128	88,-
IFT 10K-4L	15	0,5	0,5	1,5	9	B	890,- ↓	963-128	88,-
IFT 30K-3	30	1	1	3	9	B	890,- ↓	963-128	88,-
IFT 60K-3	60	2	2	6	9	B	890,- ↓	963-129	105,-
IFT 60K-3L	60	2	2	6	14	C	960,- ↓	963-129	105,-
IFT 100K-3	150	5	5	15	14	C	960,- ↓	963-129	105,-
IFT 100K-3L	150	5	5	15	22	D	1190,- ↓	963-129	105,-
IFT 300K-2L	300	10	10	30	22	D	1190,- ↓	963-129	105,-

↓ Price reduction

TIPS FROM THE EXPERTS

As well as our balances and test services, we can offer you an extensive range of professional measuring technology and testing technology as a comprehensive range of test services.

We will offer you reliable quality at fair prices and with the shortest delivery times. Our product specialists will give you professional advice, will work with you to find the right product and will provide comprehensive support after the purchase too.

For all details on our ranges, please see www.kern-sohn.com or request your own personal catalogues right now: Telephone +49 7433 9933-0



Stefan Herrmann, Product Manager
SAUTER measuring equipment

#4 “New: High-quality load cells for force and mass measurement”

Accuracy classes with rated loads from 300g to 50t and protection classes up to IP69K are now available in the SAUTER product range. For which project whatsoever, whether to build individual weighing systems, for installation in silos and storage containers or shelves for continuous inventory, for special applications in mechanical engineering or any kind of test stands – SAUTER offers a suitable measuring cell.

Of course, we also supply the right accessories, such as load corners, rod ends, evaluation units, junction box or the appropriate calibration certificate.

Special wishes? Special load cells, other capacities or cable lengths, individual dynamometers or a special receptacle for your test object? No problem, our product specialist “Load cells”, Mr. Stefan Herrmann, will be pleased to help you at any time and work with you to develop an individual concept for your application.

All load cells and measuring instruments can be found in the new SAUTER catalogue 2019 for measuring technology and test services

FORCE MEASUREMENT

Load cell + SAUTER FH + Software



WAAGENBAU

Load cell + KERN YKV + KERN Software BalanceConnection

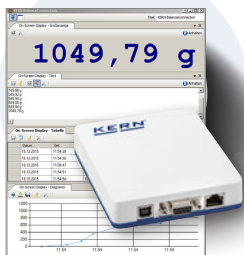

BALANCE MANUFACTURE

Load cell + Junction Box + KERN YKV



BALANCE MANUFACTURE

Load cell + display device



BALANCE MANUFACTURE

Load cell + Junction Box + display device



SAUTER Mess measuring cells – integration opportunities

Floor scales/Pallet scales/Drive-through scales

Robust aid for weighing large loads

KERN offers a carefully coordinated range from affordable entry level models, to practical built-in solutions, up to the top level verified models made of stainless steel. Their common feature is the long-lasting industrial quality as well as the high level of protection against dust and spray.

The installation, startup, and possible verification of floor, pallet, and drive-through scales require specialised knowledge, which is the basis for a successful sale. Please ask for our "Floor scale info sheet".

High-capacity scales – ideal for piece counting with large item quantities

The weighing ranges of bench counting scales are often not sufficient to count large quantities, units, palletised items etc. This is where high-performance counting systems are employed as these combine a high-precision reference balance with a high-capacity bulk scale, such as e.g. floor scales, pallet scales or drive-through scales. Your personal KERN customer consultant will be happy to help you setting up the right high-capacity counting system.

Individuality is the trump card – we create your ideal scale!

Do you have any special requests, which are not covered by our extensive floor scale range? Then why not configure your ideal model yourself, it's quick, individual and affordable.

Of course we can also offer you the complete service and put the required scale combination together for you, including verification. All further details can be found from page 134 ff. or ask your personal customer service agent, he will be pleased to advise you



Florian Bächle

Product specialist Floor scales/
Pallet scales/Drive-through scales
Tel. +49 7433 9933-118
Fax +49 7433 9933-29118
florian.baechle@kern-sohn.com

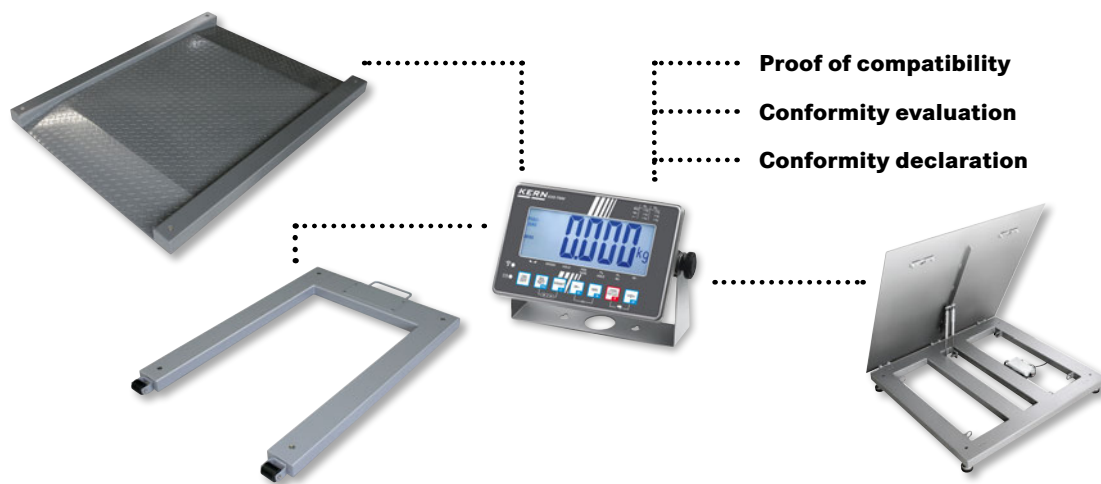

HIGHLIGHT

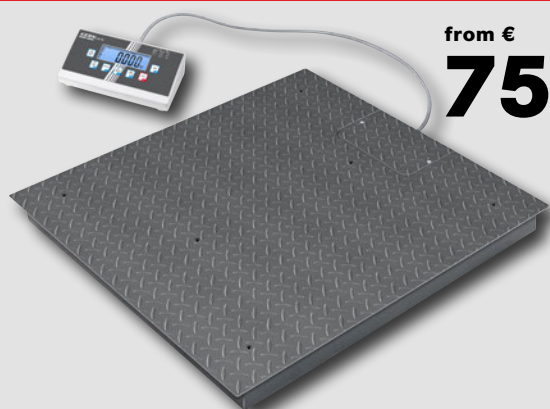

from €
750,-

- High-resolution floor scale with 2 x 3000 [d]
- Massive steel weighing bridge with IP67 protection
- Optimised price performance ratio

Quick-Finder Floor scales/Pallet scales/Drive-through scales

Readability [d] g	Weighing capacity [Max] kg	Weighing plate WxDxH mm	Model KERN	Price excl. of VAT ex works €	Page	 For an explanation on the pictos, see the front flap										
100 200	300 600	1000×1000×108	BIC 600K-1S	750,-	117	2		•					•			
100 200	300 600	1200×1500×108	BIC 600K-1	900,-	117	2		•					•			
100 200	300 600	1000×1000×108	BID 600K-1DSM	1090,-	118	2	○	•	•	•		•				
100 200	300 600	1200×1500×108	BID 600K-1DM	1320,-	118	2	○	•	•	•		•				
200	600	1000×1000×108	BID 600K-1SM	1020,-	118	2	○	•	•	•		•				
200	600	1200×1500×108	BID 600K-1M	1250,-	118	2	○	•	•	•		•				
200	600	1000×1000×85	BFB 600K-1SNM	1100,-	120	2	○	•	•	•		•		○		
200	600	1500×1250×85	BFB 600K-1NM	1480,-	120	2	○	•	•	•		•		○		
200	600	1000×1000×85	BFA 600K-1SNM	1160,-	122	5	○	•	○	•		•		•	○	
200	600	1500×1250×85	BFA 600K-1NM	1580,-	122	5	○	•	○	•		•		•	○	
200	600	1000×1000×80	BXS 600K-1SM	1490,-	123	2	○	•	○	•		•		•	○	
200	600	1500×1250×80	BXS 600K-1M	1700,-	123	2	○	•	○	•		•		•	○	
200	600	1000×1000×80	BFN 600K-1SM	2600,-	124	2	○	•	○	•		•		•	○	
200	600	1000×1000×110	BKN 600K-1SM	3400,-	125	7	○	•	○	•		•		•	○	
200	600	1500×1250×110	BKN 600K-1M	4200,-	125	7	○	•	○	•		•		•	○	
200	600	800×120×85	UFA 600K-1S	870,-	127	2		•	•	•		•		•	○	
200	600	1195×840×110	UIB 600K-1	740,-	128	2		•				•				
200	600	1190×840×90	UFB 600K200M	930,-	129	2	○	•	•	•		•		○		
200	600	840×1300×90	UFN 600K200IPM	1490,-	131	2	○	•	○	•		•		•	○	
200	600	1600×1200×80	NFB 600K200M	1360,-	132	2	○	•	○	•		•		•	○	
200	600	1800×1400×80	NFB 600K200LM	1590,-	132	2	○	•	○	•		•		•	○	
200	600	1600×1200×80	NFN 600K-1M	2950,-	133	2	○	•	○	•		•		•	○	
200 500	600 1500	1000×1000×108	BIC 1T-4S	750,-	117	2		•				•				
200 500	600 1500	1200×1500×108	BIC 1T-4	950,-	117	2		•				•				
200 500	600 1500	1000×1000×108	BID 1T-4DSM	1090,-	118	2	○	•	•	•		•				
200 500	600 1500	1200×1500×108	BID 1T-4DM	1350,-	118	2	○	•	•	•		•				
500	1500	1000×1000×108	BID 1T-4SM	1020,-	118	2	○	•	•	•		•				
500	1500	1200×1000×108	BID 1T-4EM	1120,-	118	2	○	•	•	•		•				
500	1500	1200×1500×108	BID 1T-4M	1280,-	118	2	○	•	•	•		•				
500	1500	1000×1000×100	BFB 1T-4SNM	1110,-	120	2	○	•	•	•		•		○		
500	1500	1500×1250×90	BFB 1T-4NM	1480,-	120	2	○	•	•	•		•		○		
500	1500	1000×1000×95	BFA 1T-4SNM	1170,-	122	5	○	•	○	•		•		•	○	
500	1500	1500×1250×85	BFA 1T-4NM	1580,-	122	5	○	•	○	•		•		•	○	
500	1500	1000×1000×80	BXS 1.5T-4SM	1350,-	123	2	○	•	○	•		•		•	○	
500	1500	1500×1250×80	BXS 1.5T-4M	1700,-	123	2	○	•	○	•		•		•	○	
500	1500	1000×1000×80	BFN 1T-4SM	2600,-	124	2	○	•	○	•		•		•	○	
500	1500	1500×1250×80	BFN 1.5T0.5M	3350,-	124	2	○	•	○	•		•		•	○	
500	1500	1000×1000×110	BKN 1T-4SM	3500,-	125	7	○	•	○	•		•		•	○	
500	1500	1500×1250×110	BKN 1T-4M	4200,-	125	7	○	•	○	•		•		•	○	
500	1500	1270×170×85	UFA 1.5T0.5	870,-	127	2		•	•	•		•		•	○	
500	1500	1195×840×110	UIB 1.5T-4	740,-	128	2		•				•				
500	1500	1190×840×90	UFB 1.5T0.5M	930,-	129	2	○	•	•	•		•		○		
500	1500	840×1360×90	UFC 1T-1M	990,-	130	2	○	•	○	•		•		•	○	
500	1500	840×1300×90	UFN 1.5T0.5IPM	1690,-	131	2	○	•	○	•		•		•	○	
500	1500	1600×1200×80	NFB 1.5T0.5M	1360,-	132	2	○	•	○	•		•		•	○	
500	1500	1800×1400×80	NFB 1.5T0.5LM	1590,-	132	2	○	•	○	•		•		•	○	
500	1500	1600×1200×80	NFN 1.5T-4M	2950,-	133	2	○	•	○	•		•		•	○	
500 1000	1500 3000	1200×1500×108	BIC 3T-3	950,-	117	2		•				•				
500 1000	1500 3000	1500×1500×108	BIC 3T-3L	1070,-	117	2		•				•				
500 1000	1500 3000	1200×1500×108	BID 3T-3DM	1360,-	118	2	○	•	•	•		•				
500 1000	1500 3000	1500×1500×108	BID 3T-3DLM	1520,-	118	2	○	•	•	•		•				
1000	3000	1200×1500×108	BID 3T-3M	1290,-	118	2	○	•	•	•		•				
1000	3000	1500×1500×108	BID 3T-3LM	1450,-	118	2	○	•	•	•		•				
1000	3000	1500×1250×85	BFB 3T-3NM	1480,-	120	2	○	•	•	•		•		○		
1000	3000	1500×1500×80	BFB 3T1LM	1700,-	120	2	○	•	•	•		•		○		
1000	3000	1500×1250×85	BFA 3T-3NM	1580,-	122	5	○	•	○	•		•		•	○	
1000	3000	1500×1500×85	BFA 3T-3LM	1780,-	122	5	○	•	○	•		•		•	○	
1000	3000	1500×1250×80	BXS 3T-3M	1700,-	123	2	○	•	○	•		•		•	○	
1000	3000	1500×1250×80	BFN 3T-3M	3350,-	124	2	○	•	○	•		•		•	○	
1000	3000	1500×1250×110	BKN 3T-3M	4200,-	125	7	○	•	○	•		•		•	○	
1000	3000	1500×1500×110	BKN 3T-3LM	5200,-	125	7	○	•	○	•		•		•	○	
1000	3000	1270×175×65	UFA 3T1	890,-	127	2		•	•	•		•		•	○	
1000	3000	2100×160×100	UFA 3T-3L	1050,-	127	2		•	•	•		•		•	○	
1000	3000	1195×840×110	UIB 3T-3	740,-	128	2		•				•				
2000	6000	1500×1500×130	BFB 6T-3M	1950,-	120	2	○	•	•	•		•		○		
2000	6000	1500×1500×130	BFA 6T-3M	2040,-	122	5	○	•	○	•		•		•	○	
2000	6000	1270×160×100	UFA 6T-3	1190,-	127	2		•	•	•		•		•	○	
2000	6000	2100×160×100	UFA 6T-3L	1490,-	127	2		•	•	•		•		•	○	

News 2019

● = standard ○ = option

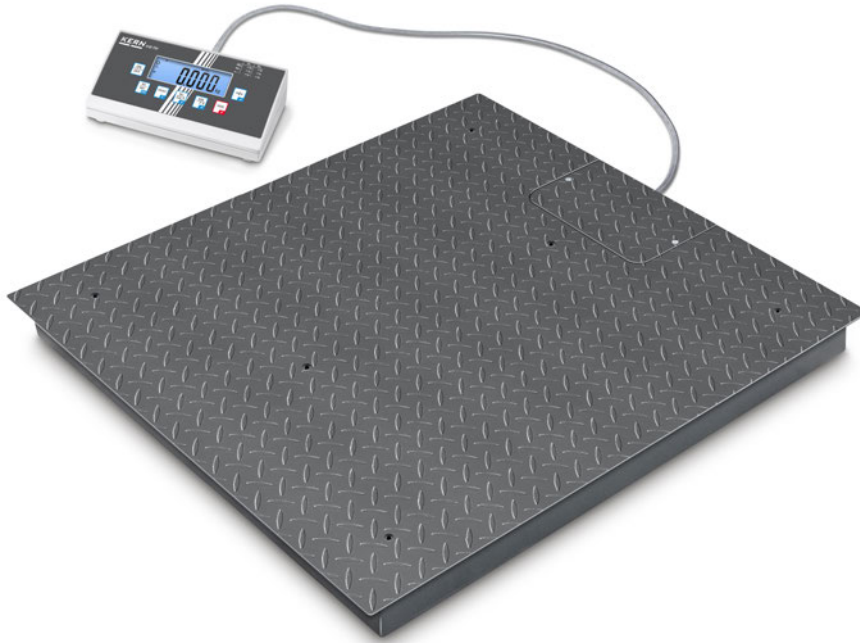

High resolution floor scale with 2×3000 [d] and the best price to performance ratio

Features

- **Weighing bridge:** out of anti-slip corrugated steel, 4 silicone-coated steel load cells, dust and spray protection IP67
- Welded platform with screw holes to lift the balance for easy cleaning
- **Easy levelling of the weighing bridge** as well as **access to the junction box** from above
- **Simple and convenient 4-key operation**
- **Wall mount** for display device, standard
- A clever **plug-in connector** means that you can easily separate the display device and the platform, e.g. for installing the balance in a packing and dispatch bench, pit frame etc. at a later date
- **Did you know?** Our floor scales are delivered in a robust wooden box. This protects the high-quality weighing technology from environmental influences and stresses during transportation. KERN – always one step ahead

Technical data

- Large LCD display, digit height 25 mm
- Weighing plate dimensions W×D×H
 - A** 1000×1000×108 mm
 - B** 1200×1500×108 mm
 - C** 1500×1500×108 mm
- Dimensions of display device W×D×H 235×114×51 mm
- Optional battery operation, 4×1.5 V AA not included, operating time up to 60 h
- Cable length of display device approx. 5 m
- Permissible ambient temperature -10 °C/40 °C

Accessories

- **Protective working cover** over display device, delivery quantity: 5 items, KERN EOB-A02S05, **€ 40,-**
- **Pair of base plates** to fix the weighing bridge to the floor, KERN BIC-A07, **€ 40,-**
- **Ascending ramp**, steel, powder coated, steel, powder coated, not included, for models with weighing plate size
 - A** 1000×1000×108 mm, KERN BIC-A01, **€ 350,-**
 - B** 1200×1000×108 mm, KERN BIC-A02, **€ 380,-**
 - C** 1500×1000×108 mm, KERN BIC-A03, **€ 460,-**
- **Stable pit frame**, steel, powder coated, for models with weighing plate size
 - A** 1088×1088×110 mm, KERN BIC-A04, **€ 295,-**
 - B** 1288×1588×110 mm, KERN BIC-A05, **€ 330,-**
 - C** 1588×1588×110 mm, KERN BIC-A06, **€ 350,-**

STANDARD

CAL EXT UNIT IP 67 BATT MULTI DMS 2 DAYS

OPTION

DAKKS +3 DAYS

! Shipment via freight forwarder. Please ask for dimensions, gross weight, shipping costs

Model	Weighing capacity [Max] kg	Readability [d] kg	Net weight approx. kg	Weighing plate	Price excl. of VAT ex works €	Option	
						DAKKS KERN	DAKKS Calibr. Certificate €
Dual-range balance switches automatically to the next largest weighing capacity [Max] and readability [d]							
BIC 600K-1S	300 600	0,1 0,2	130	A	750,- ↓	963-130	165,-
BIC 600K-1	300 600	0,1 0,2	150	B	900,- ↓	963-130	165,-
BIC 1T-4S	600 1500	0,2 0,5	130	A	750,- ↓	963-130	165,-
BIC 1T-4	600 1500	0,2 0,5	150	B	950,- ↓	963-130	165,-
BIC 3T-3	1500 3000	0,5 1	150	B	950,- ↓	963-132	440,-
BIC 3T-3L	1500 3000	0,5 1	150	C	1070,- ↓	963-132	440,-

↓ Price reduction

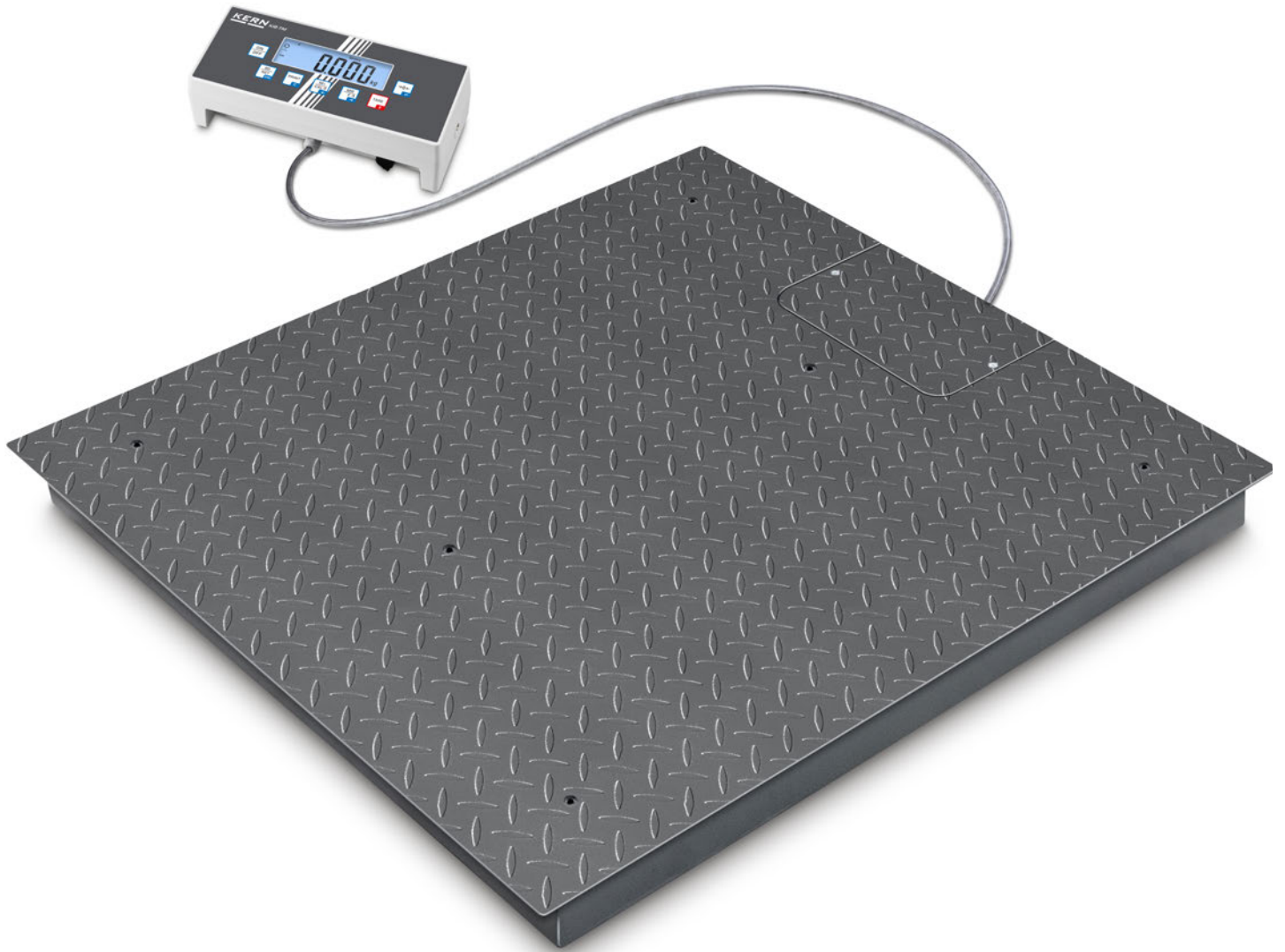

Floor scale with EC type approval [M]* and the best price-to-performance ratio – now also as a high-resolution dual-range scale

12



Did you know?

Our floor scales are delivered in a robust wooden box. This protects the high-quality weighing technology from environmental influences and stresses during transportation. KERN – always one step ahead



3 Access ramp incl. pair of base plates to facilitate access of e.g. wire cage trolleys, shelf trolleys, container trolleys, storage trolleys, sack trucks, transpallets, mobile containers, containers refuse etc.



4 Stable pit frame, to install the weighing bridge so you can drive straight on

Features

- **NEW:** now also available as a dual-range balance! Ideal, when high maximum loads need to be weighed, but in the lower load range you still need high resolution. This means that two balances can be replaced with one – which saves space and money!
- **BID 1T-4EM:** Compact special size, especially for weighing europallets
- **1 Weighing bridge:** out of anti-slip corrugated steel, 4 silicone-coated steel load cells, dust and spray protection IP67
- **Easy levelling of the weighing bridge** as well as **access to the junction box** from above
- **2 Display device:** for details see KERN KFB-TM
- **Totalising** of weights and piece counts
- Thanks to **interfaces** such as RS-232 or USB, WiFi, Bluetooth, Ethernet (optional), the scale can easily be connected to existing networks. Data exchange between the scale, PC or printer
- **Searching and remote control of the balance** using external control devices or computers with the KERN Communication Protocol (KCP). KCP is a standardised interface command structure for KERN balances and other instruments which allows you to recall and manage all relevant parameters and device functions. You can therefore simply connect KERN devices with KCP to computers, industrial control systems and other digital systems. In a large number of cases the KCP is compatible with the MT-SICS protocol. Only possible through data interface RS-232, other interfaces on request

Technical data

- Large LCD display, digit height 25 mm
- Weighing plate dimensions WxDxH
 - A 1000x1000x108 mm
 - B 1200x1000x108 mm
 - C 1200x1500x108 mm
 - D 1500x1500x108 mm
- Dimensions of display device WxDxH 260x115x70 mm
- Cable length of display device approx. 5 m
- Permissible ambient temperature -10 °C/40 °C

Accessories

- **Protective working cover**, scope of delivery: 5 items, KERN EOC-A01S05, **€ 40,-**
- **Pair of base plates** to fix the weighing bridge to the floor, KERN BIC-A07, **€ 40,-**
- **3 Ascending ramp**, steel, powder coated, steel, powder coated, for models with weighing plate size
 - A, B KERN BIC-A01, **€ 350,-**
 - C KERN BIC-A02, **€ 380,-**
 - D KERN BIC-A03, **€ 460,-**
- **4 Stable pit frame**, steel, powder coated, to install the weighing bridge so you can drive straight on, for models with weighing plate size
 - A KERN BIC-A04, **€ 295,-**
 - B KERN BIC-A08, **€ 330,-**
 - C KERN BIC-A05, **€ 330,-**
 - D KERN BIC-A06, **€ 350,-**
- **Benchtop stand incl. wall mount** for display device, **Benchtop stand incl. wall mount** for display device, KERN EOC-A04, **€ 30,-**
- **Rechargeable battery pack internal**, operating time up to 43 h without backlight, charging time approx. 3 h, KERN KFB-A01, **€ 35,-**

- **USB data interface**, for transferring weighing to the PC, printer, USB sticks etc., not possible in combination with verification, KERN KIB-A03, **€ 120,-**
- **Bluetooth data interface** for wireless data transfer to PC or tablets, must be ordered at purchase, not in combination with verification, KERN KIB-A04, **€ 110,-**
- **WiFi interface** for wireless connection of the balance to networks and WiFi capable devices, such as tablets, laptops or smartphones, must be ordered at purchase, please ask for delivery time, KERN KIB-A10, **€ 55,-**
- **Ethernet data interface**, to connect an IP-based Ethernet network, must be ordered at purchase, not in combination with verification, not in combination with KERN KIB-A03, KIB-A04, KIB-A10. KERN KIB-A02, **€ 150,-**
- **Signal lamp, including interface**, for visual support of weighing with tolerance range, KERN KIB-A06, **€ 320,-**

Note: For verified scales the weighing bridge must be fixed to the floor. Optionally, with an access ramp, a footplate pair or a pit frame

1 Shipment via freight forwarder. Please ask for dimensions, gross weight, shipping costs

STANDARD

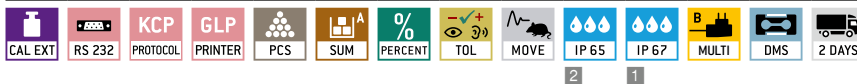

OPTION



FACTORY



Model	Weighing capacity [Max] kg	Readability = Verification value [d] = [e] kg	Minimal load [Min] kg	Net weight approx. kg	Weighing plate	Price excl. of VAT ex works €	Option			
							Verification		DAkKS Calibr. Certificate	
KERN							M KERN	€	DAKKS KERN	€
BID 600K-1SM	600	0,2	4	130	A	1020,-	965-230	132,-	963-130	165,-
BID 600K-1M	600	0,2	4	150	C	1250,-	965-230	132,-	963-130	165,-
BID 1T-4SM	1500	0,5	10	130	A	1020,-	965-230	132,-	963-130	165,-
BID 1T-4M	1500	0,5	10	75	C	1280,-	965-230	132,-	963-130	165,-
BID 1T-4EM	1500	0,5	10	65	B	1120,-	965-230	132,-	963-130	165,-
BID 3T-3M	3000	1	20	150	C	1290,-	965-232	200,-	963-132	440,-
BID 3T-3LM	3000	1	20	150	D	1450,-	965-232	200,-	963-132	440,-
Dual-range balance switches automatically to the next largest weighing capacity [Max] and readability [d]										
BID 600K-1DSM	300 600	0,1 0,2	4	130	A	1090,-	965-230	132,-	963-130	165,-
BID 600K-1DM	300 600	0,1 0,2	4	150	C	1320,-	965-230	132,-	963-130	165,-
BID 1T-4DSM	600 1500	0,2 0,5	10	130	A	1090,-	965-230	132,-	963-130	165,-
BID 1T-4DM	600 1500	0,2 0,5	10	150	C	1350,-	965-230	132,-	963-130	165,-
BID 3T-3DM	1500 3000	0,5 1	20	150	C	1360,-	965-232	200,-	963-132	440,-
BID 3T-3DLM	1500 3000	0,5 1	20	150	D	1520,-	965-232	200,-	963-132	440,-

Note: For applications that require verification, please order verification at the same time, initial verification at a later date is not possible. Verification at the factory, we need to know the full address of the location of use.

NEW New model

Price reduction

* Verification not in combination with KERN KIB-A02, KIB-A03, KIB-A04, KIB-A10

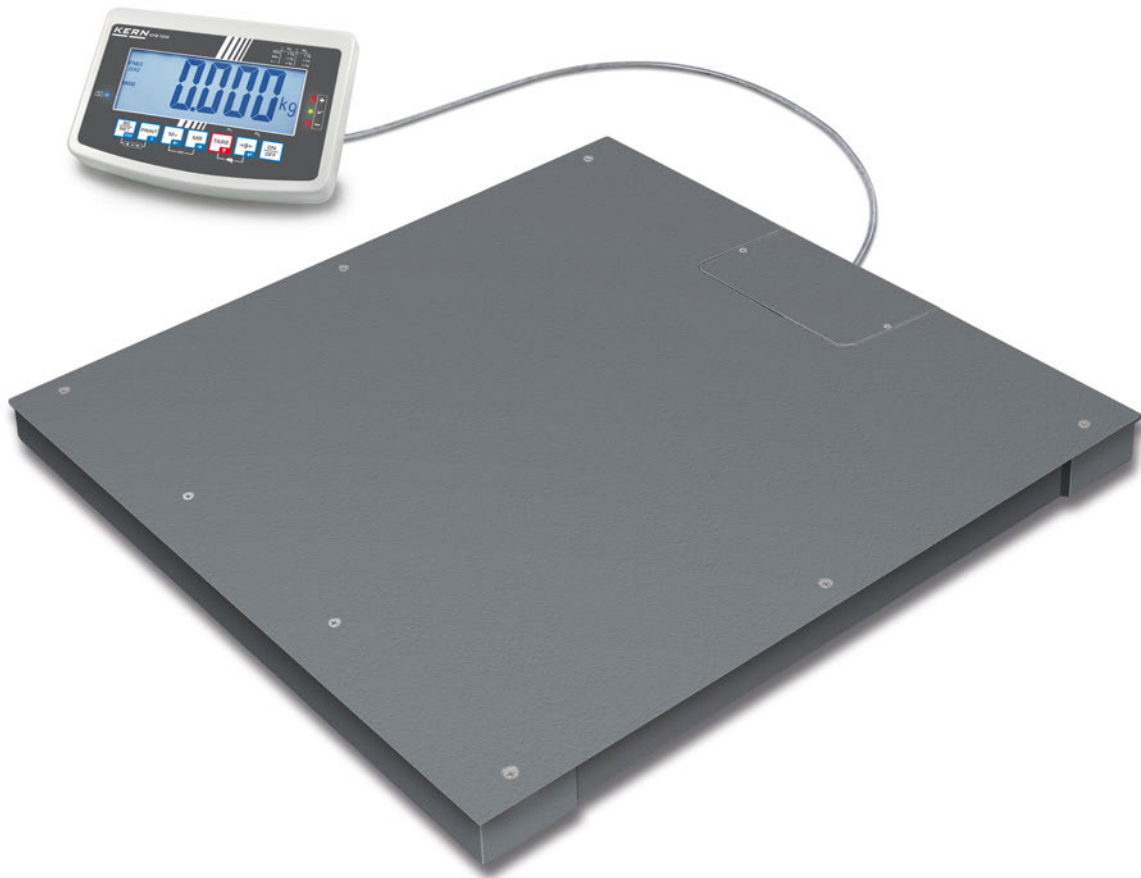

12 Weighing bridge with screwed-on weighing plate (IP67) and XXL display device, with EC type approval [M]



Weighing plate can be unscrewed

The weighing plate can be conveniently unscrewed for maintenance or cleaning purposes (weighing plate size **A**, **B**)



Easy levelling of the weighing bridge as well as access to the junction box from above



Did you know? Our floor scales are delivered in a robust wooden box. This protects the high-quality weighing technology from environmental influences and stresses during transportation. KERN – always one step ahead



Features

- **Weighing plate** **A**, **B** **screwed on from the top**, so it's easy to remove, hygienic and easy to clean
- **1 Weighing bridge**: steel, painted, weighing plate size **C**, **D** corrugated steel plate, welded, 4 silicone-coated steel load cells, dust and spray protection IP67
- **Display device**: for details see KERN KFB-TM
- **Benchtop stand incl. wall mount** for display device as standard
- **Totalising** of weights and piece counts
- **Protective working cover** included with delivery

Technical data

- Large backlit LCD display, digit height 52 mm
- Weighing plate dimensions W×D×H
 - A** 1000×1000×85 mm
 - B** 1500×1250×85 mm
 - C** 1500×1500×80 mm
 - D** 1500×1500×130 mm
- Dimensions of display device W×D×H 250×160×58 mm
- Cable length of display device approx. 5 m
- Permissible ambient temperature -10 °C/40 °C

Accessories

- **Protective working cover**, scope of delivery: 5 items, KERN KFB-A02S05, **€ 40,-**
- **2 Stand** to elevate display device, height of stand approx. 800 mm, KERN BFS-A07, **€ 120,-**
- **Pair of base plates** to fix the weighing bridge to the floor, for models with weighing plate size
 - A**, **B**, **C** KERN BFS-A06N, **€ 70,-**
 - D** KERN BFS-A10, **€ 60,-**
- **3 Ascending ramp**, steel, lacquered, not included, for models with weighing plate size
 - A** KERN BFS-A01N, **€ 310,-**
 - B** KERN BFS-A02N, **€ 350,-**
 - C** KERN BFS-A09, **€ 410,-**
 - D** KERN BFS-A11, **€ 500,-**
- **4 Stable pit frame**, steel, lacquered, for models with weighing plate size
 - A** KERN BFS-A03N, **€ 310,-**
 - B** KERN BFS-A04N, **€ 370,-**
 - C** KERN BFS-A08, **€ 365,-**
- **Rechargeable battery pack internal**, operating time up to 35 h without backlight, charging time approx. 10 h, must be ordered at purchase, KERN KFB-A01, **€ 35,-**
- **Bluetooth data interface** for wireless data transfer to PC or tablets, must be ordered at purchase, not in combination with verification, not possible in combination with RS-232

- data interface, KERN KFB-A03, **€ 130,-**
- Analogue module, must be ordered at purchase, not possible in combination with signal lamp
 - 0-10 V: KERN KFB-A04, **€ 95,-**
 - 4-20 mA: KERN KFB-A05, **€ 95,-**
- **Signal lamp** for visual support of weighing with tolerance range, KERN CFS-A03, **€ 250,-**
- **Large display with superior display size**, KERN YKD-A02, **€ 220,-**
- **Cable with special length** 15 m, between display device and platform, for verified models which must be ordered at the time of purchase, KERN BFB-A03, **€ 160,-**
- Further details, plenty of further accessories and suitable printers see *Accessories*

Note: For verified scales the weighing bridge must be fixed to the floor. Optionally, with an access ramp, a footplate pair or a pit frame

I Shipment via freight forwarder. Please ask for dimensions, gross weight, shipping costs

STANDARD: CAL EXT, RS 232, PCS, SUM, TOL, MOVE, IP 67, MULTI, DMS, 2 DAYS

OPTION: DAKKS +3 DAYS

FACTORY: BT 2.0, ANALOG, ACCU, +3 DAYS

Model	Weighing capacity [Max] kg	Readability = Verification value [d] = [e] kg	Minimal load [Min] kg	Net weight approx. kg	Weighing plate	Price excl. of VAT ex works €	Option			
							Verification		DAkkS Calibr. Certificate	
							M III KERN	€	DAkkS KERN	€
BFB 600K-1SNM	600	0,2	4	105	A	1 100,-	965-230	132,-	963-130	165,-
BFB 600K-1NM	600	0,2	4	135	B	1 480,-	965-230	132,-	963-130	165,-
BFB 1T-4SNM	1500	0,5	10	100	A	1 110,-	965-230	132,-	963-130	165,-
BFB 1T-4NM	1500	0,5	10	135	B	1 480,-	965-230	132,-	963-130	165,-
BFB 3T-3NM	3000	1	20	135	B	1 480,-	965-232	200,-	963-132	440,-
BFB 3T1LM	3000	1	20	155	C	1 700,-	965-232	200,-	963-132	440,-
BFB 6T-3M	6000	2	40	210	D	1 950,-	965-232	200,-	963-132	440,-

Note: For applications that require verification, please order verification at the same time, initial verification at a later date is not possible. Verification at the factory, we need to know the full address of the location of use.

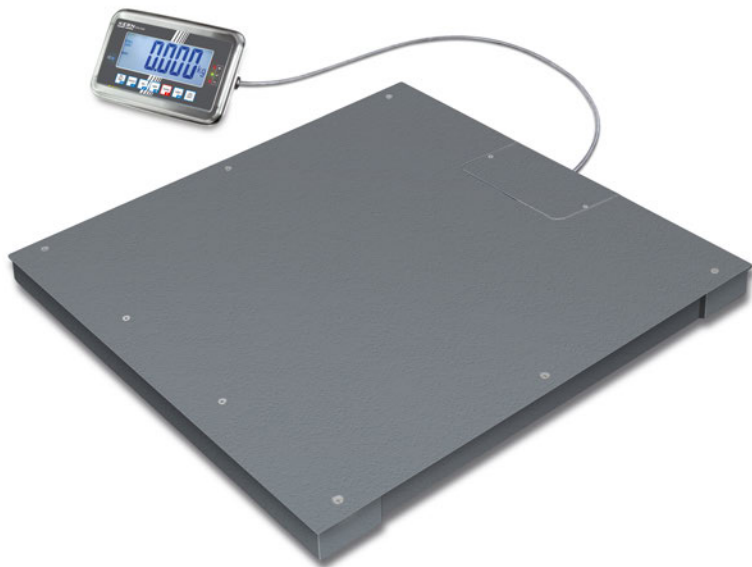

Weighing bridge with screwed-on weighing plate (IP67) and stainless steel display device (IP68), with EC type approval [M]

Features

- **Tough industry standard** suitable for use in harsh industrial applications
- **1 Weighing plate** **C, D** screwed on from the top, so it's easy to remove, hygienic and easy to clean
- **2 Weighing bridge:** steel, painted, weighing plate size **C, D** corrugated steel plate, welded, 4 silicone-coated steel load cells, dust and spray protection IP67. Weighing bridge can also be delivered as component without the display device, for details see KERN KFP-V20 IP67
- **Easy levelling of the weighing bridge** as well as **access to the junction box** from above
- **3 Display device:** stainless steel, protection against dust and water splashes IP65
- **Benchtop stand incl. wall mount** for display device as standard

Technical data

- Large backlit LCD display, digit height 52 mm
- Weighing plate dimensions WxDxH
 - A** 1000x1000x85 mm
 - B** 1500x1250x85 mm
 - C** 1500x1500x80 mm
 - D** 1500x1500x130 mm
- Dimensions of display device WxDxH 266x165x96 mm
- Cable length of display device approx. 5 m
- Rechargeable battery pack internal, operating time up to 35 h without backlight, charging time approx. 12 h
- Permissible ambient temperature -10 °C/40 °C

Accessories

- **4 Stand** to elevate display device, height of stand approx. 800 mm, KERN BFS-A07, **€ 120,-**

- **Pair of base plates** to fix the weighing bridge to the floor, for models with weighing plate size
 - A, B, C** KERN BFS-A06N, **€ 70,-**
 - D** KERN BFS-A10, **€ 60,-**
- **Ascending ramp**, steel, lacquered, for models with weighing plate size
 - A** KERN BFS-A01N, **€ 310,-**
 - B** KERN BFS-A02N, **€ 350,-**
 - C** KERN BFS-A09, **€ 410,-**
 - D** KERN BFS-A11, **€ 500,-**
- **Stable pit frame**, steel, lacquered, for models with weighing plate size
 - A** KERN BFS-A03N, **€ 310,-**
 - B** KERN BFS-A04N, **€ 370,-**
 - C** KERN BFS-A08, **€ 365,-**
 - D** KERN BFS-A12, **€ 650,-**
- **Rechargeable battery pack internal**, operating time up to 35 h without backlight, charging time approx. 12 h, KERN GAB-A04, **€ 40,-**
- **Data interface RS-232**, interface cable included, approx. 1,5 m, must be ordered at purchase, KERN KFN-A01, **€ 95,-**
- **Large display with superior display size**, KERN YKD-A02, **€ 220,-**
- **Cable with special length** 15 m, between display device and platform, for verified models which must be ordered at the time of purchase, KERN BFB-A03, **€ 160,-**
- Further details, plenty of further accessories and suitable printers see *Accessories*

Note: For verified scales the weighing bridge must be fixed to the floor. Optionally, with an access ramp, a footplate pair or a pit frame

! Shipment via freight forwarder. Please ask for dimensions, gross weight, shipping costs

STANDARD										OPTION		FACTORY		
					3	2	3							

Model	Weighing capacity [Max] kg	Readability = Verification value [d] = [e] kg	Minimal load [Min] kg	Net weight approx. kg	Weighing plate	Price excl. of VAT ex works €	Option			
							Verification		DAkkS Calibr. Certificate	
KERN							€	DAkkS KERN	€	
BFA 600K-1SNM	600	0,2	4	105	A	1160,-	965-230	132,-	963-130	165,-
BFA 600K-1NM	600	0,2	4	135	B	1580,-	965-230	132,-	963-130	165,-
BFA 1T-4SNM	1500	0,5	10	100	A	1170,-	965-230	132,-	963-130	165,-
BFA 1T-4NM	1500	0,5	10	135	B	1580,-	965-230	132,-	963-130	165,-
BFA 3T-3NM	3000	1	20	135	B	1580,-	965-232	200,-	963-132	440,-
BFA 3T-3LM	3000	1	20	160	C	1780,-	965-232	200,-	963-132	440,-
BFA 6T-3M	6000	2	40	210	D	2040,-	965-232	200,-	963-132	440,-

Note: For applications that require verification, please order verification at the same time, initial verification at a later date is not possible. Verification at the factory, we need to know the full address of the location of use.

! ONLY WHILE STOCKS LAST

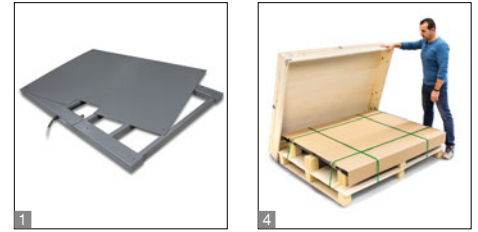
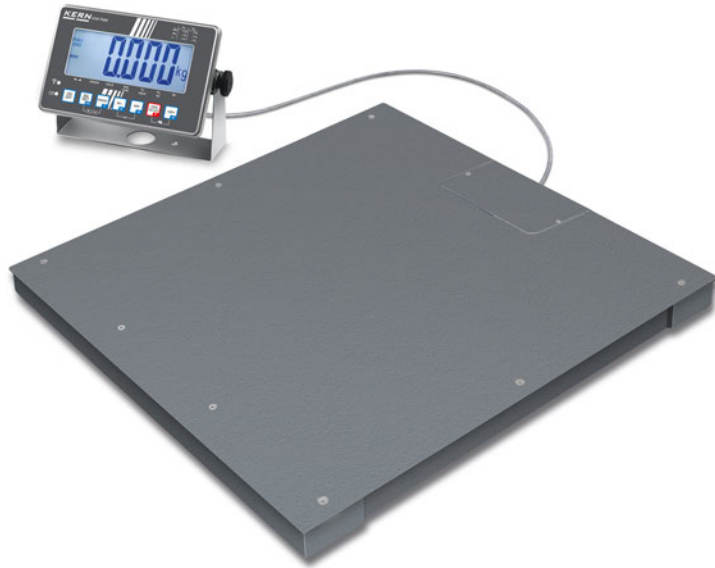

Weighing bridge with screwed-on weighing plate (IP67) and stainless steel display device (IP68), with EC type approval [M]

Features

- **Tough industry standard** suitable for use in harsh industrial applications
- **1 Weighing plate screwed on from the top**, so it's easy to remove, hygienic and easy to clean
- **2 Weighing bridge:** steel, painted, extremely resistant to bending due to material thickness, 4 silicone-coated steel load cells, dust and spray protection IP67.
- **Easy levelling of the weighing bridge** as well as **access to the junction box** from above
- **3 Display device:** stainless steel, protection against dust and water splashes IP68, for industrial applications, hygienic and easy to clean, integrated power supply
- **Benchtop stand incl. wall mount** for display device as standard
- **Totalising** of weights and piece counts
- Thanks to **interfaces** such as RS-232, RS-485 and Bluetooth (optional) the scale can easily be connected to existing networks and facilitates the data exchange between the scale and printer

- **4 Did you know?** Our floor scales are delivered in a robust wooden box. This protects the high-quality weighing technology from environmental influences and stresses during transportation. KERN – always one step ahead

Technical data

- Large backlit LCD display, digit height 55 mm
- Weighing plate dimensions, steel, painted W×D×H
 - A** 1000×1000×80 mm
 - B** 1500×1250×80 mm
- Dimensions of display device W×D×H 232×170×80 mm
- Cable length of display device approx. 5 m
- Permissible ambient temperature -10 °C/40 °C

Accessories

- **Stand** to elevate display device, height of stand approx. 750 mm, KERN YKP-02, **€ 190,-**
- **Pair of base plates** to fix the weighing bridge to the floor, KERN BXS-A03, **€ 70,-**
- **Ascending ramp**, steel, lacquered, for models with weighing plate size
 - A** KERN BXS-A01, **€ 350,-**
 - B** KERN BXS-A02, **€ 400,-**
- **Rechargeable battery pack internal**, operating time up to 80 h, without backlight, charging time approx. 12 h, KERN GAB-A04, **€ 40,-**
- **Data interface RS-232**, interface cable included, approx. 1,5 m, must be ordered at purchase, KERN KXS-A04, **€ 100,-**
- **Data interface RS-485**, must be ordered at purchase, KERN KXS-A01, **€ 145,-**
- **Bluetooth data interface** for wireless data transfer to PC or tablets, must be ordered at purchase, not in combination with verification, KERN KXS-A02, **€ 170,-**
- **Foot switch**, must be ordered at purchase, KERN KXS-A03, **€ 130,-**
- **Cable with special length** 15 m, between display device and platform, for verified models which must be ordered at the time of purchase, KERN BFB-A03, **€ 160,-**
- Further details, plenty of further accessories and suitable printers see *Accessories*

Note: For verified scales the weighing bridge must be fixed to the floor. Optionally, with an access ramp, a footplate pair or a pit frame

! Shipment via freight forwarder. Please ask for dimensions, gross weight, shipping costs

STANDARD

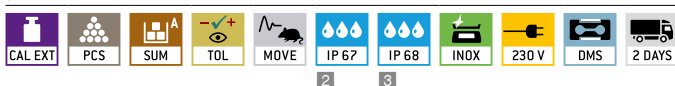

OPTION



FACTORY

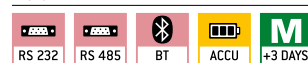

Model	Weighing capacity [Max] kg	Readability = Verification value [d] = [e] kg	Minimal load [Min] kg	Net weight approx. kg	Weighing plate	Price excl. of VAT ex works €	Option			
							Verification		DAKkS Calibr. Certificate	
		M000 KERN		€		DAKkS KERN		€		
BXS 600K-1SM	600	0,2	4	100	A	1490,-	965-230	132,-	963-130	165,-
BXS 600K-1M	600	0,2	4	145	B	1650,-	965-230	132,-	963-130	165,-
BXS 1.5T-4SM	1500	0,5	10	100	A	1350,-	965-230	132,-	963-130	165,-
BXS 1.5T-4M	1500	0,5	10	145	B	1700,-	965-230	132,-	963-130	165,-
BXS 3T-3M	3000	1	20	145	B	1700,-	965-232	200,-	963-132	440,-

Note: For applications that require verification, please order verification at the same time, initial verification at a later date is not possible. Verification at the factory, we need to know the full address of the location of use.

! ONLY WHILE STOCKS LAST

! Price reduction



Stainless steel weighing bridge with screwed-on weighing plate (IP68) and stainless steel display device (IP65), with EC type approval [M]

Features

- **Tough industry standard** suitable for use in harsh industrial applications
- **Weighing plate screwed on from the top**, with stainless steel screws, so it's easy to remove, hygienic and easy to clean
- **1 Weighing bridge:** stainless steel, extremely resistant to bending due to material thickness, 4 welded stainless steel load cells, dust and spray protection IP68. Weighing bridge can also be delivered as component without the display device, for details see KERN KFP-V40
- Your support in a **HACCP-compliant** quality system
- **Easy levelling of the weighing bridge** as well as **access to the junction box** from above
- **2 Display device:** stainless steel, protection against dust and water splashes IP65, for industrial applications, hygienic and easy to clean, integrated power supply, The display device can also be delivered as a component without the weighing bridge, for details see KERN KFN-TM
- **Benchtop stand incl. wall mount** for display device as standard

Accessories

- **Totalising** of weights and piece counts
- **3** Did you know? Our floor scales are delivered in a robust wooden box. This protects the high-quality weighing technology from environmental influences and stresses during transportation. KERN – always one step ahead

Accessories

- **4 Stand** to elevate display device, height of stand approx. 800 mm, KERN YKP-02, **€ 285,-**
- **Pair of base plates** to fix the weighing bridge to the floor, KERN BFN-A03, **€ 60,-**
- **5 Ascending ramp**, stainless steel, not included, for models with weighing plate size KERN BFN-A05, **€ 1090,-**
KERN BFN-A01, **€ 1120,-**
- **6 Stable pit frame**, stainless steel, for models with weighing plate size KERN BFN-A06, **€ 730,-**
KERN BFN-A02, **€ 850,-**
- **Data interface RS-232**, interface cable included, approx. 1,5 m, must be ordered at purchase, KERN KFN-A01, **€ 95,-**
- **Cable with special length** 15 m, between display device and platform, for verified models which must be ordered at the time of purchase, KERN BFB-A03, **€ 160,-**
- Further details, plenty of further accessories and suitable printers see *Accessories*

Technical data

- Large backlit LCD display, digit height 52 mm
- Dimensions of display device W×D×H 266×165×96 mm
- Cable length of display device approx. 5 m
- Weighing plate dimensions W×D×H
A 1000×1000×85 mm
B 1500×1200×80 mm
- **Rechargeable battery pack internal**, operating time up to 35 h without backlight, charging time approx. 12 h
- Permissible ambient temperature -10 °C/40 °C

Note: For verified scales the weighing bridge must be fixed to the floor. Optionally, with an access ramp, a footplate pair or a pit frame

1 Shipment via freight forwarder. Please ask for dimensions, gross weight, shipping costs

STANDARD

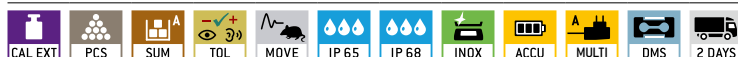

OPTION



FACTORY



Model	Weighing capacity [Max] kg	Readability = Verification value [d] = [e] kg	Minimal load [Min] kg	Net weight approx. kg	Weighing plate	Price excl. of VAT ex works €	Option			
							Verification		DAkKS Calibr. Certificate	
KERN							M KERN	€	DAkKS KERN	€
BFN 600K-1SM	600	0,2	4	100	A	2600,-	965-230	132,-	963-130	165,-
BFN 1T-4SM	1500	0,5	10	100	A	2600,-	965-230	132,-	963-130	165,-
BFN 1.5T0.5M	1500	0,5	10	135	B	3350,-	965-230	132,-	963-130	165,-
BFN 3T-3M	3000	1	20	135	B	3350,-	965-232	200,-	963-132	440,-

Note: For applications that require verification, please order verification at the same time, initial verification at a later date is not possible. Verification at the factory, we need to know the full address of the location of use.

1 ONLY WHILE STOCKS LAST



Stainless steel floor scale with folding weighing plate and complete dust and spray protection to IP68 and EC type approval [M]



To clean or service the floor scale, the weighing plate can be opened easily using two retractable handles, without damaging your back

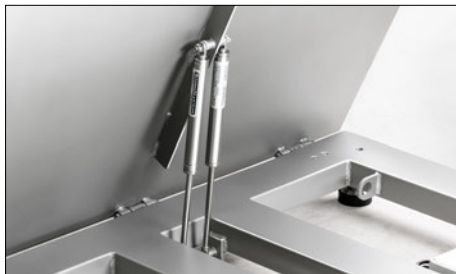

Two high-performance absorbers ensure maximum comfort when lifting and lowering the weighing plate



Cavities and concealed edges are avoided by using hermetically welded section tubes. When combined with the clever frame structure, which reduces potential contamination areas, the result is a floor scale design which is of special benefit when used in areas where hygiene is particularly important.



Features

- **Tough industry standard** suitable for use in harsh industrial applications
- Your support in a **HACCP-compliant** quality system
- **Weighing bridge:** stainless steel, extremely resistant to bending due to material thickness, 4 welded 17-4 PH/1.4542 load cells, dust and spray protection IP68. Weighing bridge can also be delivered as component without the display device, for details see KERN KKP-V40
- **Easy levelling of the weighing bridge** as well as **access to the junction box** from above
- **1 Display device:** stainless steel, protection against dust and water splashes IP68, for industrial applications, hygienic and easy to clean, integrated power supply. The display device can also be delivered as a component without the weighing bridge, for details see KERN KXS-TM
- **2 Benchtop stand incl. wall mount** for display device as standard
- **Weighing with tolerance range (check-weighing):** A visual and audible signal assists the rapid checking of items on pallets
- **Totalising** of weights and piece counts
- **2** Thanks to **interfaces** such as RS-232, RS-485 and Bluetooth (optional) the scale can easily be connected to existing networks and facilitates the data exchange between the scale and printer
- **3** Did you know? Our floor scales are delivered in a robust wooden box. This protects the high-quality weighing technology from environmental influences and stresses during transportation. KERN – always one step ahead

Technical data

- Large backlit LCD display, digit height 55 mm
- Cable length of display device approx. 5 m
- Weighing plate dimensions W×D×H
 - A** 1000×1000×110 mm
 - B** 1500×1250×110 mm
 - C** 1500×1500×110 mm
- Permissible ambient temperature -10 °C/40 °C

Accessories

- **Stand** to elevate display device, height of stand approx. 750 mm, KERN YKP-02, **€ 190,-**
- **Pair of base plates** to fix the weighing bridge to the floor, KERN BKN-A07, **€ 65,-**
- **Ascending ramp**, stainless steel, not included, for models with weighing plate size
 - A** KERN BKN-A01, **€ 1300,-**
 - B** KERN BKN-A02, **€ 1500,-**
 - C** KERN BKN-A03, **€ 1750,-**
- **Stable pit frame**, stainless steel, for models with weighing plate size
 - A** KERN BKN-A04, **€ 1400,-**
 - B** KERN BKN-A05, **€ 1600,-**
 - C** KERN BKN-A06, **€ 1700,-**
- **Rechargeable battery pack internal**, operating time up to 80 h without backlight, charging time approx. 12 h, KERN GAB-A04, **€ 40,-**
- **Foot switch**, must be ordered at purchase, KERN KXS-A03, **€ 130,-**
- **Data interface RS-232**, interface cable included, approx. 1,5 m, must be ordered at purchase, KERN KXS-A04, **€ 100,-**
- **Data interface RS-485**, must be ordered at purchase, KERN KXS-A01, **€ 145,-**

- **Bluetooth data interface** for wireless data transfer to PC or tablets, must be ordered at purchase, not in combination with verification, KERN KXS-A02, **€ 170,-**
- **RS-232/WiFi adapter** for wireless connection to networks and WiFi capable devices, such as tablets, laptops or smartphones, KERN YKI-03, **€ 690,-**
- **RS-232/Ethernet adapter** for connection to an IP-based Ethernet network, KERN YKI-01, **€ 290,-**
- Further details, plenty of further accessories and suitable printers see *Accessories*

Note: For verified scales the weighing bridge must be fixed to the floor. Optionally, with an access ramp, a footplate pair or a pit frame

1 Shipment via freight forwarder. Please ask for dimensions, gross weight, shipping costs

Note: We will be happy to create custom products for you, such as, for example, weighing plates with holes and hooks in place of handles, other weighing plate sizes, other materials (steel grades) and much more

STANDARD



OPTION



FACTORY

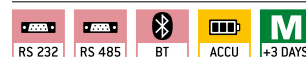

Model	Weighing capacity [Max] kg	Readability = Verification value [d] = [e] kg	Minimal load [Min] kg	Net weight approx. kg	Weighing plate	Price excl. of VAT ex works €	Option			
							Verification		DAkKS Calibr. Certificate	
							M III KERN	€	DAkKS KERN	€
BKN 600K-1SM	600	0,2	4	100	A	3400,-	965-230	132,-	963-130	165,-
BKN 600K-1M	600	0,2	4	130	B	4200,-	965-230	132,-	963-130	165,-
BKN 1T-4SM	1500	0,5	10	100	A	3500,-	965-230	132,-	963-130	165,-
BKN 1T-4M	1500	0,5	10	130	B	4200,-	965-230	132,-	963-130	165,-
BKN 3T-3M	3000	1	20	130	B	4200,-	965-232	200,-	963-132	440,-
BKN 3T-3LM	3000	1	20	160	C	5200,-	965-232	200,-	963-132	440,-

1 ONLY WHILE STOCKS LAST



Highly versatile weighing beams (IP67) for large loads to 6 t

Features

- Flexible solution for weighing large, bulky or long items
- **High mobility:** thanks to rechargeable battery operation (optional), compact, lightweight construction, it is suitable for the use in several locations
- **1 Weighing beams:** steel, painted, 4 silicone-coated aluminium load cells, protection against dust and water splashes IP67, Weighing beams can also be delivered as components without the display device, for details see KERN KFA-V20
- **Sturdy handles** for transporting the weighing beams
- **2 KERN UFA-L:** Each weighing beam has a roller and handle for easy transport of the scale
- **Display device:** for details see KERN KFB-TM
- **Benchtop stand incl. wall mount** for display device as standard
- **Totalising** of weights and piece counts
- **Protective working cover** included with delivery

- KERN UFA-S: model with short weighing beams, ideal for weighing compact items or animals in transport boxes
- Did you know? Our floor scales are delivered in a robust wooden box. This protects the high-quality weighing technology from environmental influences and stresses during transportation. KERN – always one step ahead

Technical data

- Large backlit LCD display, digit height 52 mm
- Dimensions of display device W×D×H 250×160×65 mm
- Cable length of display device approx. 5 m
- Cable length weighing beams approx. 2,5 m
- Permissible ambient temperature -10 °C/40 °C

Accessories

- **Protective working cover**, scope of delivery: 5 items, KERN KFB-A02S05, € 40,-
- **3 Stand** to elevate display device, height of stand approx. 800 mm, KERN BFS-A07, € 120,-

- **Rechargeable battery pack internal**, operating time up to 35 h without backlight, charging time approx. 10 h, KERN KFB-A01, € 35,-
- **Bluetooth data interface** for wireless data transfer to PC or tablets, must be ordered at purchase, not in combination with verification, KERN KFB-A03, € 130,-
- Analogue module, must be ordered at purchase, not possible in combination with signal lamp 0-10 V: KERN KFB-A04, € 95,- 4-20 mA: KERN KFB-A05, € 95,-
- **4 Signal lamp** for visual support of weighing with tolerance range, not possible in combination with analogue module, KERN CFS-A03, € 250,-
- **5 Large display with superior display size**, KERN YKD-A02, € 220,-
- **Y-cable** for parallel connection of two terminal devices to the RS-232 interface on the scale, e.g. signal lamp or barcode reader and printer, KERN CFS-A04, € 35,-
- **Cable with special length** 15 m, between display device and platform, for verified models which must be ordered at the time of purchase, KERN BFB-A03, € 160,-
- Further details, plenty of further accessories and suitable printers see *Accessories*

1 Shipment via freight forwarder. Please ask for dimensions, gross weight, shipping costs

STANDARD



OPTION



FACTORY



Model	Weighing capacity [Max] kg	Readability [d] kg	Net weight approx. kg	Dimensions Weighing beam W×D×H mm	Price excl. of VAT ex works €	Option	
						DAKKS KERN	Calibr. Certificate €
KERN UFA 600K-1S	600	0,2	36	A	870,-	963-130	165,-
KERN UFA 1.5T0.5	1500	0,5	38	B	870,-	963-130	165,-
KERN UFA 3T1	3000	1	38	B	890,-	963-132	440,-
KERN UFA 3T-3L	3000	1	60	D	1050,-	963-132	440,-
KERN UFA 6T-3	6000	2	85	C	1190,-	963-132	440,-
KERN UFA 6T-3L	6000	2	135	D	1490,-	963-132	440,-

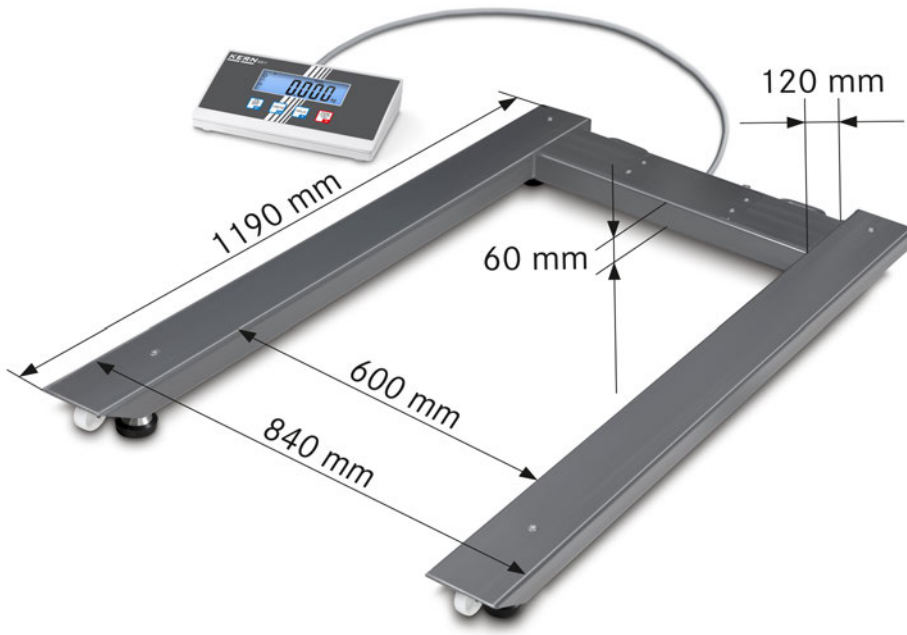

Pallet scale with steel load support (IP67) and the best price-to-performance ratio

Features

- **High mobility:** thanks to battery operation, compact, lightweight construction, it is suitable for the use in several locations
- **1 Load support:** steel, powder coated, 4 silicone-coated aluminium load cells, protection against dust and water splashes IP67
- **2** The scale can be easily transported using **rollers** and a **handle** and does not require much storage space
- **Totalising** of weights and piece counts
- **Protective working cover** included with delivery
- **3** Did you know? Our floor scales are delivered in a robust wooden box. This protects the high-quality weighing technology from environmental influences and stresses during transportation. KERN – always one step ahead

Technical data

- Large LCD display, digit height 25 mm
- Dimensions of display device W×D×H 235×115×52 mm
- Cable length of display device approx. 5 m
- Optional battery operation, 4×1.5 V AA not included, operating time up to 60 h
- Net weight approx. 55 kg
- Permissible ambient temperature -10 °C/40 °C

Accessories

- **Protective working cover** over the display device, scope of delivery: 5 items, KERN EOB-A04BS05, **€ 40,-**
- **Stand** to elevate display device, height of stand approx. 950 mm, KERN EOB-A02B, **€ 70,-**

12

STANDARD



OPTION



Model	Weighing capacity [Max] kg	Readability [d] kg	Net weight approx. kg	Price excl. of VAT ex works €	Option	
					DAKKS KERN	DAKKS Calibr. Certificate €
KERN UIB 600K-1	600	0,2	55	740,-	963-130	165,-
UIB 1.5T-4	1500	0,5	55	740,-	963-130	165,-
UIB 3T-3	3000	1	55	740,-	963-132	440,-

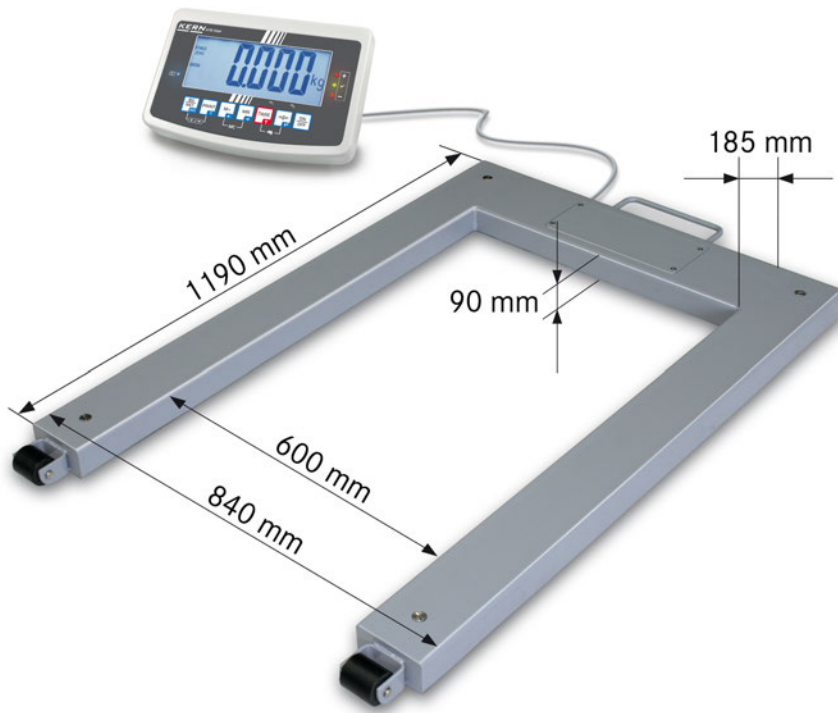

Pallet scale with steel load support (IP67) and EC type approval [M]

Features

- **High mobility:** thanks to rechargeable battery operation (optional), compact, lightweight construction, it is suitable for the use in several locations
- **1 Load support:** steel, powder coated, 4 silicone-coated aluminium load cells, protection against dust and water splashes IP67, Weighing bridge can also be delivered as component without the display device, for details see KERN KFU-V20
- Two wheels for easy transportation of the scale
- **Weighing with tolerance range (check-weighing):** A visual and audible signal assists the rapid checking of items on pallets
- **Totalising** of weights and piece counts
- **Protective working cover** included with delivery
- **2 Did you know?** Our floor scales are delivered in a robust wooden box. This protects the high-quality weighing technology from environmental influences and stresses during transportation. KERN – always one step ahead

Technical data

- Large backlit LCD display, digit height 52 mm
- Dimensions of display device WxDxH 250x160x58 mm
- Cable length of display device approx. 5 m
- Net weight approx. 55 kg
- Permissible ambient temperature -10 °C/40 °C

Accessories

- **Protective working cover**, scope of delivery: 5 items, KERN KFB-A02S05, **€ 40,-**
- **3 Stand** to elevate display device, height of stand approx. 800 mm, **Stand** to elevate display device, height of stand approx. 800 mm, KERN BFS-A07, **€ 120,-**
- **Rechargeable battery pack internal**, operating time up to 35 h without backlight, charging time approx. 12 h, KERN KFB-A01, **€ 35,-**
- **Bluetooth data interface** for wireless data transfer to PC or tablets, must be ordered at purchase, not in combination with verification, KERN KFB-A03, **€ 130,-**

- Analogue module, must be ordered at purchase, not possible in combination with signal lamp
0-10 V, KERN KFB-A04, **€ 95,-**
4-20 mA, KERN KFB-A05, **€ 95,-**
- **4 Signal lamp** for visual support of weighing with tolerance range, KERN CFS-A03, **€ 250,-**
- **5 Large display with superior display size**, KERN YKD-A02, **€ 220,-**
- **Y-cable** for parallel connection of two terminal devices to the RS-232 interface on the scale, e.g. signal lamp or barcode reader and printer, KERN CFS-A04, **€ 35,-**
- **Cable with special length** 15 m, between display device and platform, for verified models which must be ordered at the time of purchase, KERN BFB-A03, **€ 160,-**
- Further details, plenty of further accessories and suitable printers see *Accessories*

! Shipment via freight forwarder. Please ask for dimensions, gross weight, shipping costs

STANDARD



OPTION



FACTORY



Model	Weighing capacity [Max] kg	Readability [d] kg	Minimal load [Min] kg	Price excl. of VAT ex works €	Option			
					Verification		DAkkS Calibr. Certificate	
KERN						€	DAkkS KERN	€
UFB 600K200M	600	0,2	4	930,-	965-230	132,-	963-130	165,-
UFB 1.5T0.5M	1500	0,5	10	930,-	965-230	132,-	963-130	165,-

Note: For applications that require verification, please order verification at the same time, initial verification at a later date is not possible. Verification at the factory, we need to know the full address of the location of use.

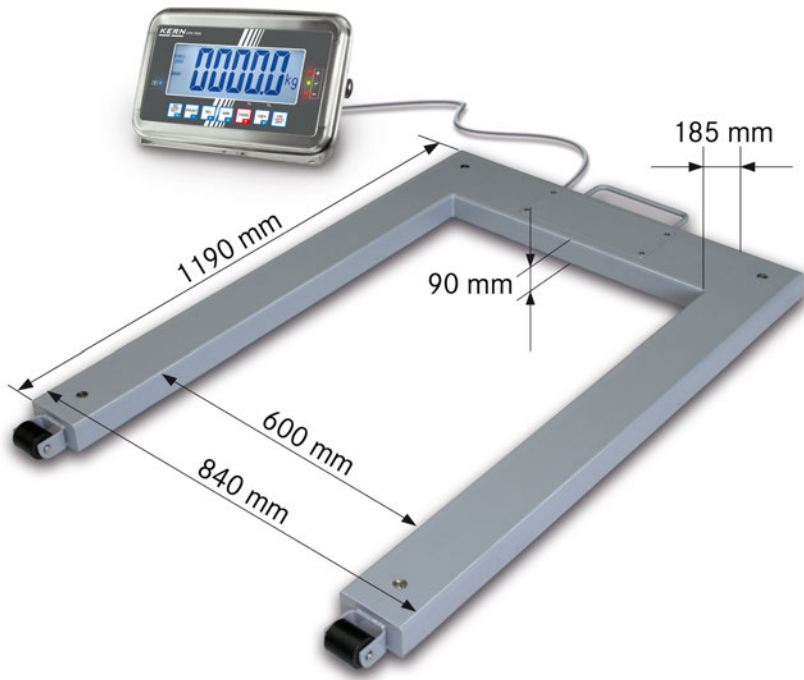

Pallet scale with steel load support (IP67) and stainless steel display device (IP65), with EC type approval [M]

Features

- **High mobility:** thanks to rechargeable battery operation (optional), compact, lightweight construction, it is suitable for the use in several locations
- **1 Load support:** steel, powder coated, 4 silicone-coated aluminium load cells, protection against dust and water splashes IP67, Weighing bridge can also be delivered as component without the display device, for details see KERN KFU V20
- Two wheels for easy transportation of the scale
- **2 Display device:** for details see KERN KFN-TM
- **Weighing with tolerance range (check-weighing):** A visual and audible signal assists the rapid checking of items on palettes
- **Totalising** of weights and piece counts
- **3 Did you know?** Our floor scales are delivered in a robust wooden box. This protects the high-quality weighing technology from environmental influences and stresses during transportation. KERN – always one step ahead

Technical data

- Large backlit LCD display, digit height 52 mm
- Dimensions of display device WxDxH 266x165x96 mm
- Cable length of display device approx. 5 m
- Net weight approx. 55 kg
- Permissible ambient temperature -10 °C/40 °C

Accessories

- **4 Stand** to elevate display device, height of stand approx. 800 mm, KERN BFS-A07, € 120,-
- **Rechargeable battery pack internal,** operating time up to 35 h without backlight, charging time approx. 12 h, KERN GAB-A04, € 40,-
- **Data interface RS-232,** interface cable included, approx. 1,5 m, KERN KFN-A01, € 95,-
- **5 Signal lamp** for visual support of weighing with tolerance range, KERN CFS-A03, € 250,-
- **6 Large display with superior display size,** KERN YKD-A02, € 220,-
- **Cable with special length** 15 m, between display device and platform, for verified models which must be ordered at the time of purchase, KERN BFB-A03, € 160,-
- **Suitable printers** see *Accessories*

! Shipment via freight forwarder. Please ask for dimensions, gross weight, shipping costs

STANDARD										OPTION		FACTORY	
				2		1							

Model	Weighing capacity [Max] kg	Readability = Verification value [d] = [e] kg	Minimal load [Min] kg	Price excl. of VAT ex works €	Option			
					Verification		DAkKS Calibr. Certificate	
KERN						€	DAkKS	€
UFC 1T-1M	1500	0,5	10	990,-	965-230	132,-	963-130	165,-

Note: For applications that require verification, please order verification at the same time, initial verification at a later date is not possible. Verification at the factory, we need to know the full address of the location of use.

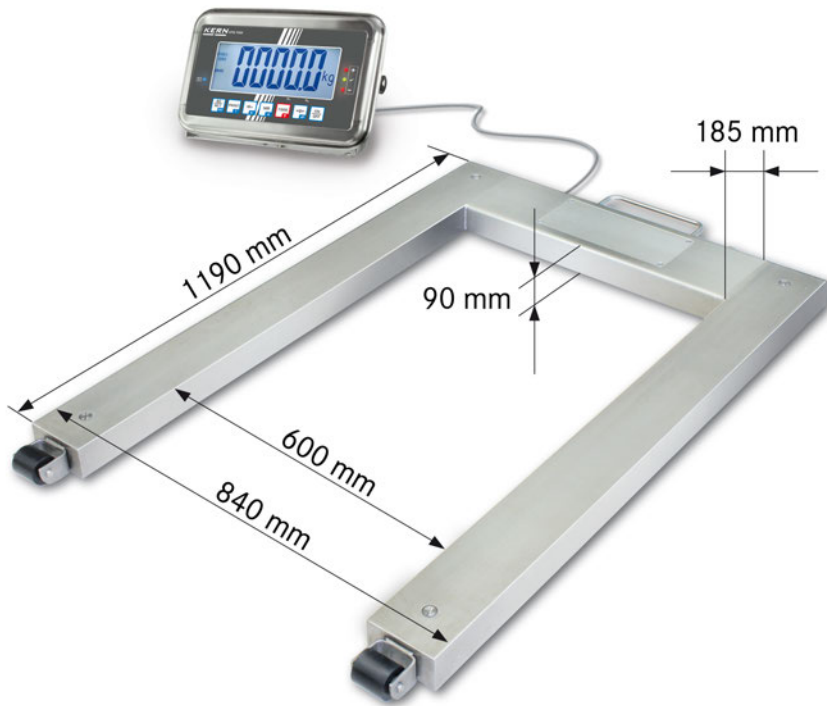

Pallet scale with stainless steel load support (IP67) and stainless steel display device (IP65), with EC type approval [M]

Features

- **High mobility:** thanks to rechargeable battery operation, compact, lightweight construction, it is suitable for the use in several locations (production, warehouse, dispatch department etc.)
- **1 Load support:** stainless steel, extremely resistant to bending due to material thickness, 4 silicone-coated stainless steel load cells, protection against dust and water splashes IP67, weighing bridge can also be delivered as component without the display device, for details see KERN KFU-V30
- Your support in a **HACCP**-compliant quality system
- **Suitable for the ever-increasing hygienic requirements** in the food industry
- **2 Display device:** for details see KERN KFN-TM
- The scale can be easily transported using **rollers** and a **handle** and does not require much storage space
- **Hold function:** When the weighing conditions are unstable, a stable weight is calculated determining an average value

Weighing with tolerance range (check-weighing): A visual and audible signal assists the rapid checking of items on pallets

- **Totalising** of weights
- **3** Did you know? Our floor scales are delivered in a robust wooden box. This protects the high-quality weighing technology from environmental influences and stresses during transportation. KERN – always one step ahead

Technical data

- Large backlit LCD display, digit height 52 mm
- Dimensions of display device WxDxH 266x165x96 mm
- Cable length of display device approx. 5 m
- Net weight approx. 55 kg
- Permissible ambient temperature -10 °C/40 °C

Accessories

- **4 Stand** to elevate display device, height of stand approx. 800 mm, KERN BFN-A04, **€ 285,-**
- **Rechargeable battery pack internal**, operating time up to 35 h without backlight, charging time approx. 10 h, KERN GAB-A04, **€ 40,-**
- **Data interface RS-232**, interface cable included, approx. 1,5 m, must be ordered at purchase, KERN KFN-A01, **€ 95,-**
- **5 Large display with superior display size**, KERN YKD-A02, **€ 220,-**
- **Cable with special length** 15 m, between display device and platform, for verified models which must be ordered at the time of purchase, KERN BFB-A03, **€ 160,-**
- Further details, plenty of further accessories and suitable printers see *Accessories*

Limited tare range with verifiable models 1/6 from [Max]

! Shipment via freight forwarder. Please ask for dimensions, gross weight, shipping costs

STANDARD										OPTION		FACTORY	
										+3 DAYS		+3 DAYS	

Model	Weighing capacity [Max] kg	Readability = Verification value [d] = [e] kg	Minimal load [Min] kg	Price excl. of VAT ex works €	Option			
					Verification		DAkKS Calibr. Certificate	
KERN						€	DAkKS KERN	€
UFN 600K200IPM	600	0,2	4	1490,-	965-230	132,-	963-130	165,-
UFN 1.5T0.5IPM	1500	0,5	10	1690,-	965-230	132,-	963-130	165,-

Note: For applications that require verification, please order verification at the same time, initial verification at a later date is not possible. Verification at the factory, we need to know the full address of the location of use.

! ONLY WHILE STOCKS LAST

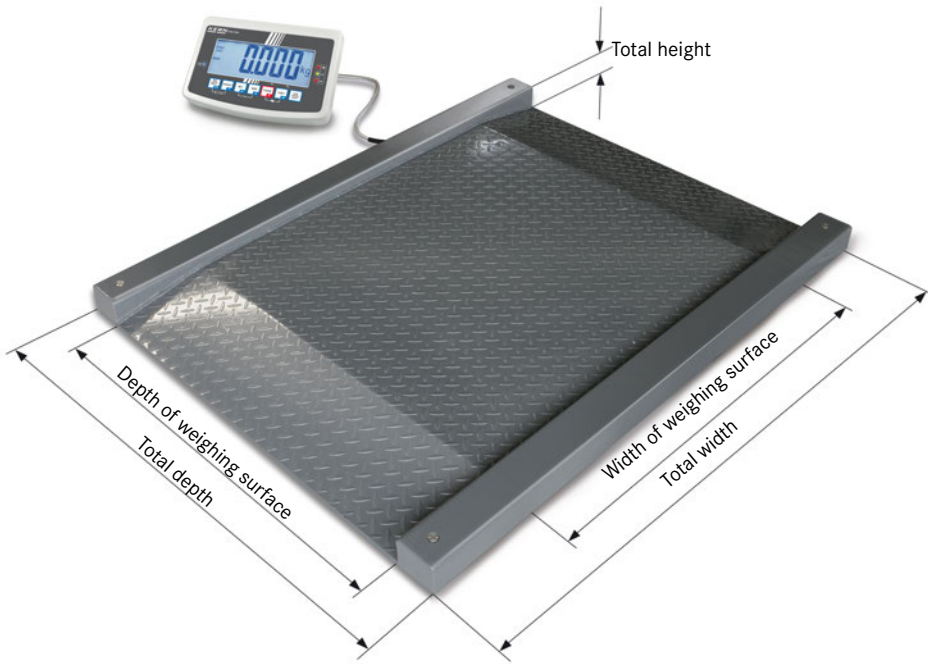

Drive-through scale (IP67) with XXL display device and EC type approval [M]

Features

- Drive-through scale for rapid weighing of e.g. wire cage trolleys, shelf trolleys, container trolleys, storage trolleys, sack trucks, transpallets, mobile containers, containers refuse etc.
- **Low platform height** and integrated access ramps on both sides facilitate access. No need for pit frame installation – which saves money
- **1** Weighing bridge: out of anti-slip corrugated steel, 4 silicone-coated steel load cells, dust and spray protection IP67
- Display device: for details see KERN KFB-TM
- Protective working cover included with delivery
- **2** Did you know? Our floor scales are delivered in a robust wooden box. This protects the high-quality weighing technology from environmental influences and stresses during transportation. KERN – always one step ahead

Technical data

- Large backlit LCD display, digit height 52 mm
- Overall dimensions W×D×H
 - A** 1600×1200×80 mm
 - B** 1800×1400×80 mm
- Platform height in the drive-through area: 80 mm
- Dimensions weighing surface
 - A** W×D 1000×1000 mm
 - B** W×D 1200×1200 mm
- Dimensions of display device W×D×H 250×160×65 mm
- Cable length of display device approx. 5 m
- Permissible ambient temperature -10 °C/40 °C

Accessories

- Protective working cover, scope of delivery: 5 items, KERN KFB-A02S05, **€ 40,-**
- **3** Stand to elevate display device, height of stand approx. 800 mm, Stand to elevate display device, height of stand approx. 800 mm, KERN BFS-A07, **€ 120,-**

- Pair of base plates to fix the weighing bridge to the floor, KERN BFS-A06, **€ 70,-**
- Rechargeable battery pack internal, operating time up to 35 h without backlight, charging time approx. 10 h, KERN KFB-A01, **€ 35,-**
- Bluetooth data interface for wireless data transfer to PC or tablets, must be ordered at purchase, not in combination with verification, KERN KFB-A03, **€ 130,-**
- Analogue module, must be ordered at purchase, not possible in combination with signal lamp 0–10 V: KERN KFB-A04, **€ 95,-**
4–20 mA: KERN KFB-A05, **€ 95,-**
- **4** **Signal lamp** for visual support of weighing with tolerance range, KERN CFS-A03, **€ 250,-**
- **5** **Large display with superior display size**, KERN YKD-A02, **€ 220,-**
- Y-cable for parallel connection of two terminal devices to the RS-232 interface on the scale, e.g. signal lamp or barcode reader and printer, KERN CFS-A04, **€ 35,-**
- Cable with special length 15 m, between display device and platform, for verified models which must be ordered at the time of purchase, KERN BFB-A03, **€ 160,-**
- Further details, plenty of further accessories and suitable printers see Accessories

Note: For verified scales the weighing bridge must be fixed to the floor. Optionally, with an access ramp, a footplate pair or a pit frame

1 Shipment via freight forwarder. Please ask for dimensions, gross weight, shipping costs

STANDARD OPTION FACTORY

Model	Weighing capacity [Max] kg	Readability = Verification value [d] = [e] kg	Minimal load [Min] kg	Net weight approx. kg	Weighing plate	Price excl. of VAT ex works €	Option			
							Verification		DAkkS Calibr. Certificate	
KERN								€	DAkkS KERN	€
NFB 600K200M	600	0,2	4	130	A	1360,-	965-230	132,-	963-130	165,-
NFB 600K200LM	600	0,2	4	165	B	1590,-	965-230	132,-	963-130	165,-
NFB 1.5T0.5M	1500	0,5	10	130	A	1360,-	965-230	132,-	963-130	165,-
NFB 1.5T0.5LM	1500	0,5	10	155	B	1590,-	965-230	132,-	963-130	165,-

Note: For applications that require verification, please order verification at the same time, initial verification at a later date is not possible. Verification at the factory, we need to know the full address of the location of use.



Stainless steel drive-through scale (IP68) with stainless steel display device (IP65), with EC type approval [M]

Features

- **Robust stainless steel drive-through scale** for rapid weighing of e.g. laundry carts, container trolleys, roller containers, etc. Ideal for hospital laundry services, goods inwards, hospital kitchens, etc.
- **Low platform height** and integrated access ramps on both sides facilitate access. No need for pit frame installation – which saves money
- **Ideal for the increased hygienic requirements** in the food, pharmaceutical and chemical industries
- **1 Weighing bridge:** stainless steel, extremely resistant to bending due to material thickness, 4 welded stainless steel load cells, dust and spray protection IP68. Weighing bridge can also be delivered as component without the display device, for details see KERN KFD-V40
- Your support in a **HACCP-compliant** quality system
- **2 Display device:** for details see KERN KFN-TM
- **Totalising** of weights and piece counts

- **3** Did you know? Our floor scales are delivered in a robust wooden box. This protects the high-quality weighing technology from environmental influences and stresses during transportation. KERN – always one step ahead

Technical data

- Large backlit LCD display, digit height 52 mm
- Overall dimensions WxDxH 1600x1200x80 mm
- Platform height in the drive-through area: 80 mm
- Dimensions of display device WxDxH 266x165x96 mm
- Cable length of display device approx. 5 m
- Permissible ambient temperature -10 °C/40 °C

Accessories

- **4 Stand** to elevate display device, height of stand approx. 800 mm, KERN BFN-A04, **€ 285,-**
- **Pair of base plates** to fix the weighing bridge to the floor, KERN BFN-A03, **€ 60,-**
- **Internal rechargeable battery pack**, operating time up to 35 h without backlight, charging time approx. 12 h, KERN GAB-A04, **€ 40,-**
- **Data interface RS-232**, interface cable included, approx. 1,5 m, must be ordered at purchase, KERN KFN-A01, **€ 95,-**
- **5 Large display with superior display size**, KERN YKD-A02, **€ 220,-**
- **Cable with special length** 15 m, between display device and platform, for verified models which must be ordered at the time of purchase, KERN BFB-A03, **€ 160,-**
- Further details, plenty of further accessories and suitable printers see *Accessories*

Note: For verified scales the weighing bridge must be fixed to the floor. Optionally, with an access ramp, a footplate pair or a pit frame

1 Shipment via freight forwarder. Please ask for dimensions, gross weight, shipping costs

STANDARD



OPTION



FACTORY



Model	Weighing capacity [Max] kg	Readability = Verification value [d] = [e] kg	Minimal load [Min] kg	Net weight approx. kg	Price excl. of VAT ex works €	Option			
						Verification		DAkkS Calibr. Certificate	
KERN							€	DAkkS KERN	€
NFN 600K-1M	600	0,2	4	130	2950,-	965-230	132,-	963-130	165,-
NFN 1.5T-4M	1500	0,5	10	125	2950,-	965-230	132,-	963-130	165,-

Note: For applications that require verification, please order verification at the same time, initial verification at a later date is not possible. Verification at the factory, we need to know the full address of the location of use.

1 ONLY WHILE STOCKS LAST

Display devices/Platforms/Weighing bridges

Putting together individual weighing systems which cannot be verified

KERN offers a range of KERN display devices and KERN weighing units, such as platform scales, floor scales, pallet scales and drive-through scales, which you can put together to make your ideal scale. You choose the components, KERN handles the rest.

Assembly

KERN delivers the complete scale which is ready to use. Prices for assembly can be found in the "Assembly" price table. On request we can also produce a calibration certificate in accordance with DAkkS/DKD at an additional price, see page 194

Putting together individual weighing systems which can be verified or are verified

In order to provide the complete package, as well as assembling your individual weighing system, KERN will also carry out the manufacturer's initial verification/evaluation for conformity in accordance with EC directives as a commercial scales of verification class III.

In accordance with the European verification regulations, when assembling a display device with a weighing unit you must take the following notes into account:

- Only elements which can be verified with build-type approval or OIML test certificate can be combined into a weighing system which can be verified. With KERN these are labelled with "M".
- Platforms with load cells, provided as third-party products which have an OIML test certificate can be included.
- It will not be possible to carry out verification at a later date, e.g. after assembly and delivery of the weighing system. So please order the verification at the same time as you order the weighing system.

You will find a wide variety of display devices, platforms, weighing bridges, etc. in KERN's product range and these can be put together to create your ideal scale. You simply choose the components, KERN handles the rest.

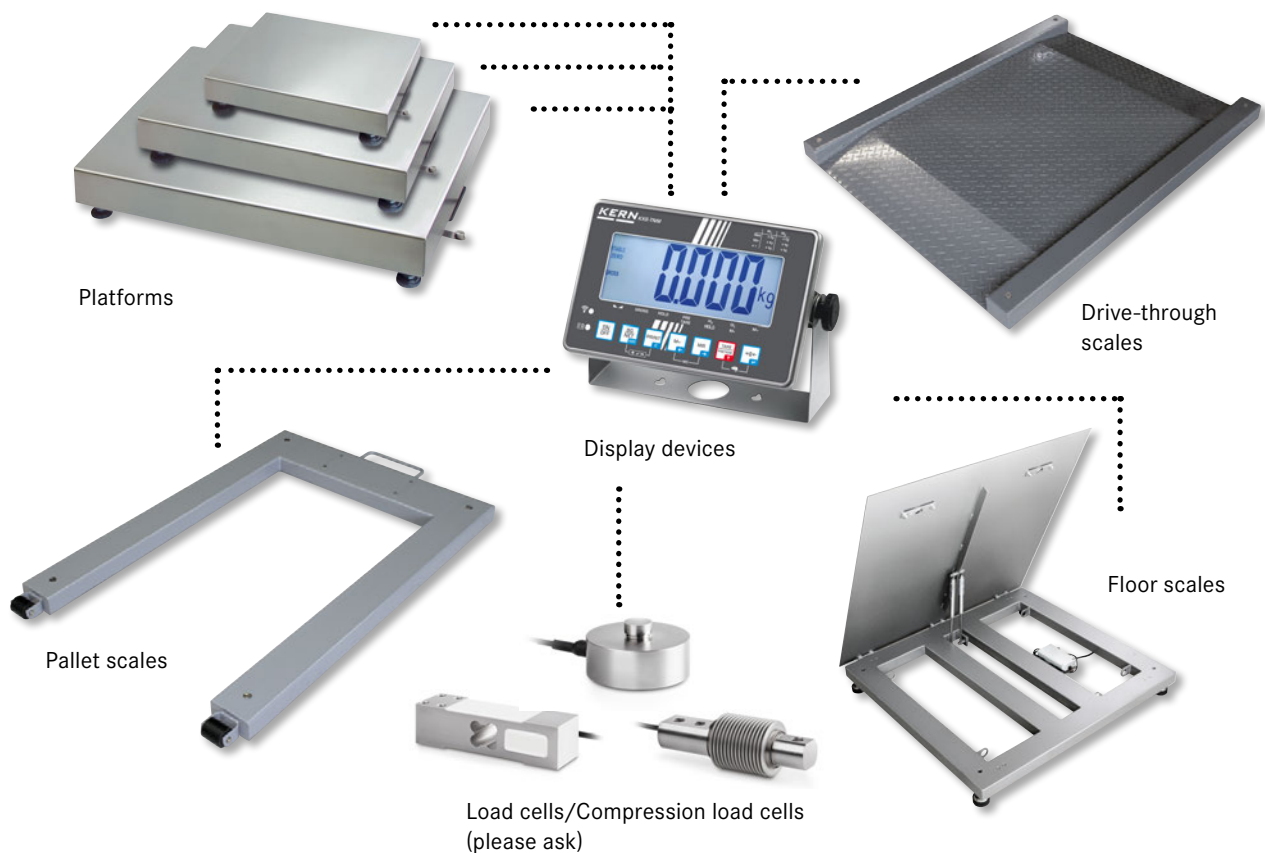

Florian Bächle
 Product specialist
 Display devices/Platforms/Weighing bridges
 Tel. +49 7433 9933-118
 Fax +49 7433 9933-29118
 florian.baechle@kern-sohn.com

The individual KERN steps:

1. Proof of compatibility This is mandatory by law and includes testing by using build-type approvals, whether the connection values of the display device match the connection data of the weighing unit.	Weighing capacity	Model	Price excl. of VAT, ex works €
	0 up ... kg	KERN	
	all Weighing capacities	965-240	45,-
2. Assembly After testing for suitability using the proof of compatibility, the weighing system will be hard wired by KERN. The weighing system will then be tested in accordance with regulations of 2014/31/EU, the European directive for non-automatic weighing instruments and prepared for conformity assessment.	up 150 kg	965-411	70,-
	up 600 kg	965-412	100,-
	up ≤ 1500 kg	965-413	120,-
	up ≤ 2900 kg	965-414	150,-
	up ≤ 6000 kg	965-415	250,-
3. Initial verification by the manufacturer Conformity assessment ("Initial verification by the manufacturer") KERN is authorised to carry out the conformity assessment ("initial verification by the manufacturer") in accordance with 2014/31/EU, the European directive for non-automatic weighing instruments and is therefore authorised to introduce the weighing system onto the market, after the test has been carried out successfully and the conformity mark has been affixed.	up ≤ 5 kg	965-227	55,-
	up ≤ 50 kg	965-228	70,-
	up ≤ 350 kg	965-229	93,-
	up ≤ 1500 kg	965-230	132,-
	up ≤ 2900 kg	965-231	150,-
	up ≤ 6000 kg	965-232	200,-
4. Declaration of conformity KERN issues this after the initial verification by the manufacturer has been carried out successfully and sends it with the weighing system at no additional cost, and it can be used in areas regulated by law.			

Modifications and special services

Description	Model	Price excl. of VAT, ex works €
Cable extensions for platform scales with build-type approval		
up to 4 m extension	965-403	45,-
up to 7 m extension	965-404	60,-
up to 10 m extension	965-405	75,-
Cable extensions for platform scales without build-type approval		
up to 4 m extension	920-403	45,-
up to 7 m extension	920-404	60,-
up to 10 m extension	920-405	75,-
Setting an individual preload		
Balance with build-type approval	965-401	50,-
Balance without build-type approval	920-406	60,-
Other adjustments in the balance or software changes	965-407	95,-/h Please ask
Plug connection (replaces the fixed cable connection between the display device and platform with a plug connection which can be disconnected)		
balances with type approval and verification	currently not possible	
balances with type approval, no verification	965-406	60,-

Order example

KFP 30V20M platform and KEN-TM display device with cable extension (4 m) and setting an individual preload.

	Model	Price excl. of VAT, ex works €
	KERN	
KERN platform	KFP 30V20M	230,-
KERN display device	KEN-TM	310,-
Proof of compatibility	965-240	45,-
Cable extension	965-403	45,-
Setting the preload	965-401	50,-
Assembly	965-411	70,-
Verification at the factory KERN	965-228	70,-
Complete scale (verified)		820,-



1 KERN KFB-TM

Display device with large digits – easy to read

2 KERN KFS-TM

Professional indicator with 3 displays, also with EC type approval [M]

Note

to see what options are offered by this display device, please see the KERN platform scale IFB on page 105

Note

to see what options are offered by this display device, please see the KERN counting scale IFS on page 90

STANDARD

CAL EXT, RS 232, GLP, PCS, SUM, UNIT, TOL

STANDARD

MOVE, MULTI, 1 DAY, ACCU, BT 2.0, ANALOG, M

STANDARD

CAL EXT, MEMORY, RS 232, GLP, INTERN, PCS, SUM, PERCENT

STANDARD

UNIT, TOL, MULTI, 1 DAY, ACCU, M

* not possible in combination with verification
 ** not possible in combination with signal lamp

Features	Model KERN	
	1 KFB-TM	2 KERN KFS-TM
Display (segments)	5 + ½ digits	6 digits
EC type approval	yes	yes
Resolution verifiable	6000 e	3000 e
Resolution non verifiable	30000 d	60000 d
Weighing capacities	≤ 2	≤ 2
Weighing units	kg, lb	kg, g
Readability	1, 2, 5, 10, n	1, 2, 5, 10, n
Piece counting with reference	10, 20, 50, 100, 200	n
Display, digit height	Backlit LCD display, 52 mm	Backlit LCD displays, 13/16,5 mm
Additional functions	Totalising, HOLD function	99 item memories, totalising, printing of date and time
Strain gauge load cells	87 – 1600 Ω	87 – 1600 Ω
Linearisation	3 points	4 points
Input voltage	12 V, 500 mA	12 V, 500 mA
Permissible ambient temperature	-10 °C/40 °C	0 °C/40 °C
Interface RS-232	yes	yes
2. Interface RS-232, separate Y cable	CFS-A04, € 35,-	CFS-A04, € 35,-
Interface RS-485	-	-
Interface USB	-	-
Interface Bluetooth	KERN KFB-A03, see page 105, € 130,-	-
Analogue module	0–10V: KERN KFB-A04, € 95,-; 4–20 mA: KERN KFB-A05, € 95,-; see page 105	-
Signal lamp	CFS-A03, € 250,-	CFS-A03, € 250,-
Foot switch	-	-
Stand	BFS-A07, see page 105, € 120,-	BFS-A07, see page 90, € 120,-
Benchtop stand for display device/wall mount	yes/yes	yes/yes
Protective working cover	KFB-A02S05, see page 105, € 40,-	KFB-A02S05, see page 90, € 40,-
Rechargeable battery pack	KFB-A01, see page 105, € 35,-	KFS-A01, see page 90, € 35,-
Operating/charging time	up to 35 h/12 h	up to 40 h/12 h
Dimensions Housing W×D×H	250×160×65 mm	260×150×65 mm
Net weight	1,2 kg	1,5 kg
Price excl. of VAT, ex works €	190,- ↓	210,-

↓ Price reduction



3 KERN KIB-TM

Practical Flip/Flop display device for greatest ease of use

Practical Flip/Flop display device:

flexible positioning e.g. free-standing or screwed to the wall (optional). By rotating the upper housing shell you can determine the angle of the display as well as the cable outlet. Factory Option ex works for an additional cost, delivery time + 2 working days, KERN KIB-M01, € 95,-

Industry 4.0: A large number of (optional) data interfaces enable convenient Transferring weighing data to tablets, laptops, PCs, networks, smartphones, printers, etc.

Searching and remote control of the balance

using external control devices or computers with the KERN Communication Protocol (KCP). KCP is a standardised interface command structure for KERN balances and other instruments which allows you to recall and manage all relevant parameters and device functions. You can therefore simply connect KERN devices with KCP to computers, industrial control systems and other digital systems. In a large number of cases the KCP is compatible with the MT-SICS protocol. Only possible through RS-232 data interface, other interfaces on request

In the KERN product range you will find a large number of platforms, weighbridges etc. which you can combine with the KERN KIB-TM display device. Simply select the components, KERN will take care of the rest.

* Verification not in combination with KERN KIB-A02, KIB-A03, KIB-A04, KIB-A10

** Ethernet data interface, to connect an IP-based Ethernet network, must be ordered at purchase, not in combination with KERN KIB-A03, KIB-A04, KIB-A10

STANDARD



OPTION



FACTORY



Features	Model KERN
	3 KIB-TM
Display (segments)	7 digits
EC type approval	yes
Resolution verifiable	3000 e
Resolution non verifiable	30000 d
Weighing capacities	≤ 2
Weighing units	kg, g
Readability	1, 2, 5, 10, n
Piece counting with reference	5, 10, 20, 25, 50, 100
Display, digit height	Backlit LCD display, 24 mm
Additional functions	Totalising, HOLD function, printing of time. KCP Only possible through RS-232; USB, Bluetooth, WLAN, Digital I/O, LAN on request
Strain gauge load cells	87-1100 Ω
Linearisation	3 points
Input voltage	12 V DC, 1000 mA
Permissible ambient temperature	-10 °C/40 °C
Interface RS-232	yes
Interface RS-485	-
Interface USB	KIB-A03, see page 102/103, € 120,-
Interface Bluetooth	KIB-A04, see page 102/103, € 110,-
WLAN	KIB-A10, see page 102/103, € 55,-
SWITCH (DIGITAL I/O)	-
LAN	KIB-A02, see page 102/103, € 150,-**
Foot switch	-
Stand	EOC-A05, see page 102/103, € 60,-
Benchtop stand for display device/wall mount	EOC-A04, € 30,-
Protective working cover	EOC-A01S05, € 40,-
Rechargeable battery pack	KFB-A01, see page 102/103, € 35,-
Operating/charging time	up to 43 h/3 h
Dimensions Housing W×D×H	268×115×70 mm
Net weight	0,8 kg
Price excl. of VAT, ex works €	190,- [↓]

[↓] Price reduction

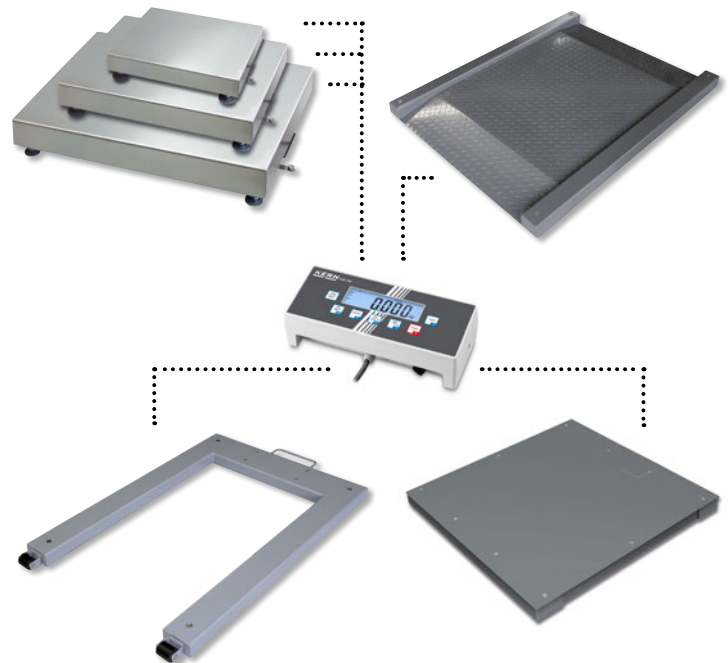

Note

to see what options are offered by this display device, please see the KERN platform scale EOC on page 102/103



4 KERN KFE-TM

Stainless steel display device with IP65 protection

5 KERN KFN-TM

Stainless steel display device with IP65 protection and superior display size

6 KERN KXS-TM

Stainless steel display device with IP68 protection and integrated power supply

Note to see what options are offered by this display device, please see the KERN SFE platform scale on page 107

Note to see what options are offered by this display device, please see the KERN SFB platform scale on page 78

Note to see what options are offered by this display device, please see the KERN SXS platform scale on page 79

STANDARD

CAL EXT, SUM, TOL, MOVE, IP 65, INOX, ACCU

STANDARD FACTORY

C MULTI, 1 DAY, M

STANDARD

CAL EXT, PCS, SUM, TOL, MOVE, IP 65, INOX

STANDARD OPTION FACTORY

C MULTI, 1 DAY, RS 232, ACCU, M

STANDARD

CAL EXT, PCS, SUM, UNIT, TOL, MOVE, IP 68

STANDARD

INOX, 230 V, 1 DAY

OPTION FACTORY

RS 232, RS 485, BT 2.0, ACCU, M

Features	Model KERN 4 KFE-TM*	Model KERN 5 KFN-TM	Model KERN 6 KXS-TM
Display (segments)	6 digits	5 + 1/2 digits	6 digits
EC type approval	yes	yes	yes
Resolution verifiable	6000 e	6000 e	10000 e
Resolution non verifiable	30000 d	30000 d	30000 d
Weighing capacities	≤ 2	≤ 2	≤ 2
Weighing units	kg	kg	kg, g
Readability	1, 2, 5, 10, n	1, 2, 5, 10, n	1, 2, 5, 10, 50
Piece counting with reference	-	10, 20, 50, 100, 200	10, 20, 50, 100, 200
Display, digit height	Backlit LCD display, 22 mm	Backlit LCD display, 52 mm	Backlit LCD display, 55 mm
Additional functions	-	Totalising, HOLD function	PRE-Tare function, totalising, HOLD function, peak hold, zero-point memorisation
Strain gauge load cells	87 – 1200 Ω	87 – 1600 Ω	87 – 1600 Ω
Linearisation	2 points	2 points	2–7 points
Input voltage	12 V, 500 mA	12 V, 500 mA	220–240 V AC
Permissible ambient temperature	-10 °C/40 °C	-10 °C/40 °C	-10 °C/40 °C
Interface RS-232	-	KFN-A01, see page 78, € 95,-	KXS-A04, € 100,-
Interface RS-485	-	-	KXS-A01, € 145,-
Interface USB	-	-	-
Interface Bluetooth	-	-	KXS-A02, € 170,- (balance ► PC)
Foot switch	-	-	KXS-A03, € 130,-
Stand	-	BFS-A07, see page 78, € 120,-	YKP-02, € 190,-
Benchtop stand for display device/wall mount	yes/yes	yes/yes	yes/yes
Protective working cover	-	-	-
Rechargeable battery pack	standard	GAB-A04, € 40,-	GAB-A04, € 40,-
Operating/charging time	up to 45 h/12 h	up to 35 h/12 h	bis zu 80 h/12 h
Dimensions Housing W×D×H	195×118×83 mm	266×165×96 mm	232×170×80 mm
Net weight	1 kg	2,6 kg	2,5 kg
Price excl. of VAT, ex works €	250,-	290,-	300,-

* ONLY WHILE STOCKS LAST!



NEW

KERN KTA-T, € 400,- (auf Anfrage)



NEW

KERN KTB-T, € 1290,- (auf Anfrage)



Convert your balance into a computer!

This modern tablet transforms your weighing components into a powerful measuring system with a wide variety of analysis options in an instant. Simply download the appropriate app on the tablet and process the weighing data according to your ideas. Thanks to this modular concept, the initial investment is kept to a minimum and, at the same time, offers you a high level of investment security and future reliability. If your requirements should increase or your area of work should expand, then simply download more Apps. In this way the investment remains predictable and you do not pay for functions which you do not need – pretty smart!

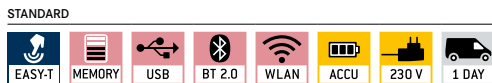

KERN KTA-T – Multifunctional tablet for connection to digital platforms, balances, measuring cells

Features

- Ideal for use in the laboratory environment, industry, test laboratories, etc., either as permanently fixed large display for one balance or as mobile display for one or more scales using WLAN or Bluetooth
- 1 Compact, slim tablet
- Superior display size in comparison with a standard display on a balance
- Separate connection for power supply, so, when charging, the USB connection remains free for USB sticks, peripheral devices, etc.
- MicroUSB to connect peripheral devices, can also be used for power supply
- For further information and extensive accessories, please see www.kern-sohn.com/de/KTA-T

Accessories

- 2 Aluminum tablet stand, infinitely adjustable in inclination for ergonomic reading and operation of the tablet, the tablet can be set upright and transversely, rubberized contact points ensure a non-slip grip and protect the tablet, W×D×H 100×35×85 mm, KERN YKD-A03, € 20,-

KERN KTB-T – Robust professional tablet for demanding weighing applications

Features

- Ideal for use in the laboratory environment, pharmaceutical field, industry, test laboratories, etc., either as permanently fixed large display for one balance or as mobile display for one or more scales using WLAN or Bluetooth
- Wide range: can be connected to a variety of balances, from the analytical balance to the floor scale, thus particularly comfortable management of the weighing systems used
- High-quality industrial tablet
- Superior display size in comparison with a standard display on a balance
- 3 Separate connection for power supply, so, when charging, the USB connection remains free for USB sticks, peripheral devices, etc.
- A large number of standard integrated interfaces allow the parallel connection of peripheral devices, storage media, network connections, etc.
- 4 Octopus cable as standard, allows the parallel connection of up to 5 peripheral devices, networks, etc. with only one interface
- MicroUSB for connecting peripheral devices as well as integrated VESA mounting preparation for mounting the tablet to a wide variety of standard mounts, tripods etc. as standard
- For further information and extensive accessories, please see www.kern-sohn.com/de/KTB-T



1 KERN KFP-V20 IP65

Platform

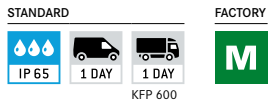

- **1 Stainless steel-weighing plate,**
A Painted steel base
- **1 load cell, aluminium, silicone-coated, IP65, OIML-R60-approved,** class III, 3000 e
- **Level indicator and levelling feet** for precise levelling of the scale

2 KERN KXP-V20 IP65

Platform



- **2 Stainless steel-weighing plate,** B Painted steel base, extremely rigid, wing design
- **1 load cell, aluminium, silicone-coated, IP65, OIML-R60-approved,** class III, 3000 e
- **Level indicator and levelling feet** for precise levelling of the scale



Model	Weighing range [Max] kg	Readability [d] g	Verification value [e] g	Min. load [Min] g	Cable length approx. m	Net weight approx. kg	Weighing plate W×D×H mm	Price excl. VAT, ex works €
1 Plattform KFP-V20 IP65								
KFP 3V20M	3	0,1	1	20	2,5	3,6	230×230×110	160,-
KFP 6V20M	6	2	1 2	40	2	3,6	230×230×110	170,-
KFP 6V20LM	6	0,2	1 2	40	2,5	6	300×240×110	190,-
KFP 15V20M	15	0,5	2 5	100	2	6	300×240×110	190,-
KFP 15V20LM	15	0,5	2 5	100	2,5	10	400×300×128	230,-
KFP 30V20SM	30	10	10	200	2,5	6	300×240×110	195,-
KFP 30V20M	30	1	5 10	200	2	10	400×300×128	230,-
KFP 60V20M	60	2	10 20	400	2	10	400×300×128	230,-
KFP 60V20LM	60	2	10 20	400	2	10	500×400×137	290,-
KFP 150V20M	150	5	20 50	1000	2	10	500×400×137	290,-
KFP 150V20LM	150	5	20 50	1000	2	22	650×500×135	510,-
KFP 300V20M	300	10	50 100	2000	2	22	650×500×135	510,-
KFP 600V20AM	600	200	200	4000	2,5	46	800×600×150	770,-
2 Plattform KXP-V20 IP65								
KXP 15V20M	15	0,5	2 5	100	3	3,2	300×240×90	230,-
KXP 6V20LM	6	0,2	1 2	40	3	3,2	300×240×90	220,-
KXP 15V20LM	15	5	5	100	3	8	400×300×90	320,-
KXP 30V20M	30	1	5 10	200	3	8	400×300×89	320,-
KXP 30V20LM	30	1	5 10	200	3	18	500×400×123	450,-
KXP 60V20M	60	2	10 20	400	3	11	400×300×89	330,-
KXP 60V20LM	60	2	10 20	400	3	22	500×400×123	460,-
KXP 150V20M	150	5	20 50	1000	3	18	500×400×123	450,-
KXP 150V20LM	150	5	20 50	1000	3	34	650×500×133,5	540,-
KXP 300V20M	300	10	50 100	2000	3	34	650×500×133,5	540,-

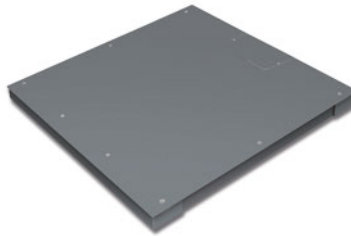
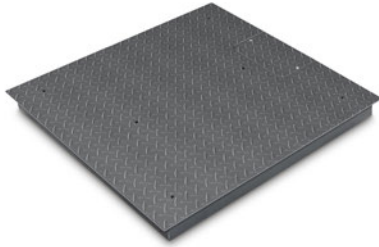

1 KERN KIP-V20M

Weighing bridge



- Weighing bridge with non-slip chequer plate, lacquered, welded
- **4 Load cells, steel, silicone-coated, IP67, OIML-R60-approval for verification, class III, 3000 e**
- Can be built in using pit frames (optional)
- **Level indicator and levelling feet** for precise levelling of the scale
- **Easy access to the junction box** from the top
- **Comfortable levelling of the weighing bridge** from the top
- Accessories page 118/119 (KERN BID)

2 KERN KFP-V20 IP67

Weighing bridge



- **A Weighing plate screwed on from the top (models with [Max] ≤ 1500 kg)**, so it easy to remove, hygienic and easy to clean.
- **Lacquered steel weighing bridge**, weighing plate size 1500×1500×130 mm corrugated steel plate. Extremely resistant to bending due to material thickness
- **4 Load cells, steel, silicone-coated, IP67, OIML-R60-approval for verification, class III, 3000 e**
- Can be built in using pit frames (optional)
- **Level indicator and levelling feet** for precise levelling of the scale
- **Easy access to the junction box** from the top
- **Comfortable levelling of the weighing bridge** from the top
- Accessories page 120/121 (KERN BFB)

3 KERN KFD-V20

Weighing bridge



- **Weighing bridge made of non-slip corrugated steel plate**, lacquered, two access ramps integrated, extremely resistant to bending
- Extremely flat construction to facilitate access: access height only 45 mm
- **4 Load cells, alloy steel, silicone-coated, IP67, OIML-R60-approval** class III, 3000 e
- Accessories page 132 (KERN NFB)



Model	Weighing range [Max] kg	Readability [d] g	Verification value [e] g	Min. load [Min] g	Cable length approx. m	Net weight approx. kg	Weighing plate W×D×H mm	Price excl. VAT, ex works €
1 Weighing bridge KIP-V20M								
KIP 600V20SM	600	200	200	4000	5	130	1000×1000×108	900,-
KIP 600V20M	600	200	200	4000	5	150	1500×1200×108	1150,-
KIP 1500V20SM	1500	500	500	10000	5	130	1000×1000×108	920,- ↓
KIP 1500V20EM	1500	500	500	10000	5	140	1250×1000×108	1020,- ↓
KIP 1500V20M	1500	500	500	10000	5	150	1500×1250×108	1180,- ↓
KIP 3000V20M	3000	1000	1000	20000	5	150	1500×1250×108	1190,- ↓
KIP 3000V20LM	3000	1000	1000	20000	5	180	1500×1500×108	1350,- ↓
2 Weighing bridge KFP-V20 IP67								
KFP 600V20SNM	600	200	200	4000	5	105	1000×1000×80	990,-
KFP 600V20NM	600	200	200	4000	5	135	1500×1250×80	1380,- ↓
KFP 1500V20SNM	1500	500	500	10000	5	105	1000×1000×80	1010,-
KFP 1500V20NM	1500	500	500	10000	5	135	1500×1250×80	1380,- ↓
KFP 3000V20NM	3000	1000	1000	20000	5	135	1500×1250×80	1380,- ↓
KFP 3000V20LM	3000	1000	1000	20000	5	155	1500×1500×80	1450,- ↓
KFP 6000V20M	6000	2000	2000	40000	5	210	1500×1500×130	1850,- ↓
3 Weighing bridge KFD-V20								
KFD 600V20M	600	200	200	4000	5	125	1600×1200×78	1310,- ↓
KFD 600V20LM	600	200	200	4000	5	155	1800×1400×80	1540,- ↓
KFD 1500V20M	1500	500	500	10000	5	125	1600×1200×78	1310,- ↓
KFD 1500V20LM	1500	500	500	10000	5	175	1800×1400×78	1540,- ↓

↓ Price reduction



4 KERN KFA-V20

Weighing beams

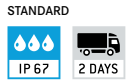

- **4 Weighing beams and painted steel base**
- **4 load cells, alloy steel, silicone-coated, IP67**
- **Levelling feet** for precise levelling of the weighing beams
- **D Image below: Version up to 6 t available.** Each weighing beam has a roller and handle for easy transport of the scale (KERN KFA-L)
- **NEW:** new model with short weighing beams, ideal for weighing compact items or animals in transport boxes
 - ▶ KERN KFA-600V20S
- Accessories page 127 (KERN UFA)

5 KERN KFU-V20/V30

U-Weighing bridge



- **5 Load range:** painted steel (V20), stainless steel (V30) height 90 mm
- **4 load cells, alloy steel, silicone-coated, IP67, OIML-R60-approval for verification, class III, 3000 e**
- **2 rollers and handle** for easy transport of the scale
- Accessories KFU-V20 page 129 (KERN UFB)
- Accessories KFU-V30 page 131 (KERN UFN)

6 KERN KFP-V30

Platform



- **6 Stainless steel-weighing plate, E Stainless steel substructure**
- **1 load cell, Stainless steel, silicone-coated, IP67, OIML-approved, class III, 3000 e**
- **Level indicator and levelling feet** for precise levelling of the scale



Note
For additional models with 4 encapsulated stainless steel load cells (IP68) see the website, KERN UFN-BM



Model	Weighing range [Max] kg	Readability [d] g	Verification value [e] g	Min. load [Min] g	Cable length approx. m	Net weight approx. kg	Weighing plate W×D×H mm	Price excl. VAT, ex works €
4 Weighing beams KFA-V20								
KFA 600V20S	600	200	-	-	5	30	800×120×100	730,- ↓
KFA 1500V20	1500	500	-	-	5	36	1200×120×100	750,- ↓
KFA 3000V20	3000	1000	-	-	5	36	1200×120×100	750,- ↓
KFA 3000V20L	3000	1000	-	-	5	65	2000×120×100	1150,-
KFA 6000V20L	6000	2000	-	-	5	125	2100×160×85	1550,-
KFA 6000V20	6000	2000	-	-	5	85	1200×160×80	1220,-
5 U-Weighing bridge KFU-V20								
KFU 600V20M	600	200	200	4000	5	55	840×1300×90	830,-
KFU 1500V20M	1500	500	500	10000	5	55	840×1300×90	830,- ↓
5 Stainless steel U-Weighing bridge KFU-V30								
KFU 600V30M*	600	200	200	4000	2,5	55	840×1300×90	1390,- ↓
KFU 1500V30M*	1500	500	500	10000	2,5	55	840×1300×90	1590,- ↓
6 Stainless steel platform KFP-V30								
KFP 15V30M	15	0,5	5	100	2,5	5,0	300×240×100	480,-
KFP 30V30M	30	1	10	200	2,5	10	400×300×128	540,-
KFP 30V30SM	30	10	10	200	2,5	5,0	300×240×100	490,-
KFP 60V30LM	60	2	20	400	2,5	10	500×400×137	650,-
KFP 60V30M	60	2	20	400	2,5	10	400×300×128	550,-
KFP 60V30XLM	60	2	20	400	2,5	22	650×500×142	990,-
KFP 150V30SM	150	5	50	1000	2,5	10	400×300×128	540,-
KFP 150V30M	150	5	50	1000	2,5	10	500×400×137	660,-
KFP 150V30LM	150	5	50	1000	2,5	22	650×500×135	990,-
KFP 300V30M	300	10	100	2000	2,5	22	650×500×135	990,-

* ONLY WHILE STOCKS LAST!

↓ Price reduction



7 KERN KFP-V40

Weighing bridge

STANDARD FACTORY

IP 68 INOX 2 DAYS M

- **7** Weighing bridge entirely made of stainless steel, extremely resistant to bending because of its high material thickness
- **F** Weighing plate fixed with stainless steel screws, for easier access to the loadcells from above
- **4 load cells, stainless steel, encapsulated, IP68, OIML-R60-approved**, class III, 3000 e
- Can be built in using pit frames (optional)
- **Level indicator and levelling feet** for precise levelling of the scale
- **Comfortable levelling of the weighing bridge** from the top
- Accessories page 124 (KERN BFN)

8 KERN KFD-V40

Weighing bridge

STANDARD FACTORY

IP 68 INOX 2 DAYS M

- **8** Weighing bridge made from stainless steel, two integrated access ramps, extremely resistant to bending
- Extremely flat construction to facilitate access: access height only 45 mm
- **4 load cells, stainless steel, encapsulated IP68, OIML-R60-approval for verification**, class III, 3000 e
- **Level indicator and levelling feet** for precise levelling of the scale
- Accessories page 133 (KERN NFN)

9 KERN KKP-V40

Weighing bridge

STANDARD FACTORY

IP 68 INOX 5 DAYS M

- **9** Weighing bridge made entirely of stainless steel, extremely resistant to bending because of its high material thickness
- **G** To clean or service the floor scale, the weighing plate can be flipped up easily using two retractable handles, without damaging your back
- **4 load cells, stainless steel, encapsulated IP68, OIML-R60-approval for verification**, class III, 3000 e
- Can be built in using pit frames (optional)
- **Level indicator and levelling feet** for precise levelling of the scale
- **Comfortable levelling of the weighing bridge** from the top
- Accessories page 125/126 (KERN BKN)

Note We will be happy to create custom products for you, such as, for example weighing plates with holes and hooks in place of handles, other weighing plate sizes, other materials (steel grades) and much more.



Model	Weighing range [Max] kg	Readability [d] g	Verification value [e] g	Min. load [Min] g	Cable length approx. m	Net weight approx. kg	Weighing plate W×D×H mm	Price excl. VAT, ex works €
7 Stainless steel weighing bridge KFP-V40								
KFP 600V40SM	600	200	200	4000	5	95	1000×1000×80	2610,-
KFP 1500V40M	1500	500	500	10000	5	135	1500×1250×80	3330,-
KFP 1500V40SM	1500	500	500	10000	5	95	1000×1000×80	2690,-
KFP 3000V40M	3000	1000	1000	20000	5	135	1500×1250×80	3350,-
8 Stainless steel weighing bridge KFD-V40								
KFD 600V40M	600	200	200	4000	5	130	1600×1200×78	2900,- ↓
KFD 1500V40M	1500	500	500	10000	5	130	1600×1200×78	2900,- ↓
9 Stainless steel weighing bridge KKP-V40								
KKP 600V40M	600	200	200	4000	5	125	1500×1250×110	3900,-
KKP 600V40SM	600	200	200	4000	5	95	1000×1000×110	3200,-
KKP 1500V40M	1500	500	500	10000	5	125	1500×1250×110	3900,-
KKP 1500V40SM	1500	500	500	10000	5	95	1000×1000×110	3200,-
KKP 3000V40LM	3000	1000	1000	20000	5	150	1500×1500×110	5400,-
KKP 3000V40M	3000	1000	1000	20000	5	125	1500×1250×110	3900,-

ONLY WHILE STOCKS LAST!

↓ Price reduction

Pallet truck scales

Weighing and transporting – just one operation

Speed up your warehouse and dispatch processes with the KERN pallet truck scales.

Get the exact weight of a load and at the same time, transport it to a specific location, all in one operation. This reduces commissioning times and avoids queues in front of fixed floor scales.

These mobile weighing solutions are space-saving and deliver reliable weighing results. Differences between given and actual weights can be determined quickly e.g. in the goods-in and out department. This uncovers inaccurate quantities, saves time and money and therefore ensures a very short amortisation period of the scales original cost.

KERN offers a carefully coordinated range from the affordable entry level model to the comfort model with removable battery pack.

KERN pallet truck scales are of robust industrial quality, with high-level protection against dust and water splashes, with high-contrast, easy-to-read displays as well as solid wheels and load rollers – all this helps to give you practical support in your work – day after day.

Of course, all KERN pallet truck scales can also be calibrated and delivered with a DAkkS calibration certificate (optional). This ensures the high level of accuracy of your pallet truck scale.

Quick-Finder Pallet truck scales

Readability [d] kg	Weighing capacity [Max] kg	Model KERN	Price excl. of VAT ex works €	Page	DAYS	CAL EXT	SUM	IP	BATT	ACCU	For an explanation on the pictos, see front flap					
											2	●	●	●		●
1	2000	VFB 2T-3	1480,-	146	2	●	●	●		●						
1	2000	VHB 2T1	1310,-	147	2	●	●	●		●						
5	2000	VHE 2T5A	990,-	145	2	●		●		●						

● = standard ○ = option



Fabienne Kolbus

Product specialist Pallet truck scales

Tel. +49 7433 9933-305

Fax +49 7433 9933-29305

fabienne.kolbus@kern-sohn.com

HIGHLIGHT



only €
990,-

- The power pack in the dispatch department and the warehouse
- The display device is well-protected by a metal frame
- Optimised load rollers so that you can get over rough ground more easily and greater manoeuvrability



Entry-level model into mobile weighing

Features

- **Highly versatile for general checkweighing**, e.g. plausibility check at goods receiving, determining shipping weights, avoiding overloads, safety checks
- **Very manoeuvrable** thanks to its compact construction and low weight
- **Particularly robust** with its components having been relocated from the load fork into the protected housing area. It is therefore also ideal for heavy applications in the production area and on board lorries
- **Display device:** plastic, protection against dust and water splashes IP65
- **Low height of the loading forks** easy uplifting to work with low pallets
- **Pivot range 206°**
- **Castors:** Solid rubber on aluminium rims
- **Load rollers:** Polyurethane

Operation:

- 1 Switch on and then pump up the load fork to the reference height
 - 2 Tare off
 - 3 Release the load fork and load the goods to be weighed
 - 4 Weighing: Pump the load fork with the goods to be weighed up to the reference height, read off the weight
- **Ready for use:** Batteries included, 2× 1.5 V AA, operating time up to 100 h, AUTO-OFF function to preserve the battery

Technical data

- Large LCD display, digit height 18 mm
- Permissible ambient temperature -10 °C/40 °C

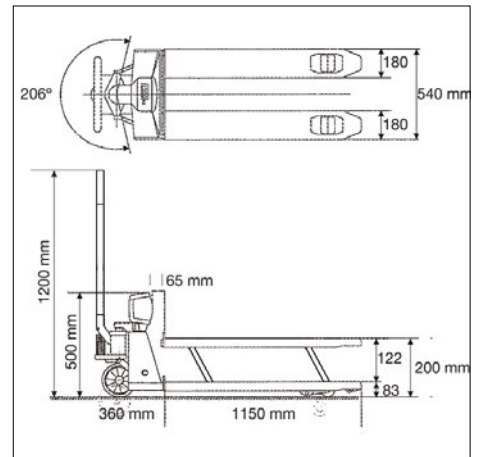

Shipment via freight forwarder. Please ask for dimensions, gross weight, shipping

STANDARD					OPTION	
CAL EXT	IP 65	BATT	DMS	2 DAYS	DAKKS	+3 DAYS

Model	Weighing capacity	Readability	Net weight	Price excl. of VAT ex works €	Option	
					DAKKS KERN	DAKKS Calibr. Certificate €
KERN VHE 2T5A	[Max] kg 2000	[d] kg 5	approx. kg 65	990,-	963-131	220,-

ONLY WHILE STOCKS LAST!

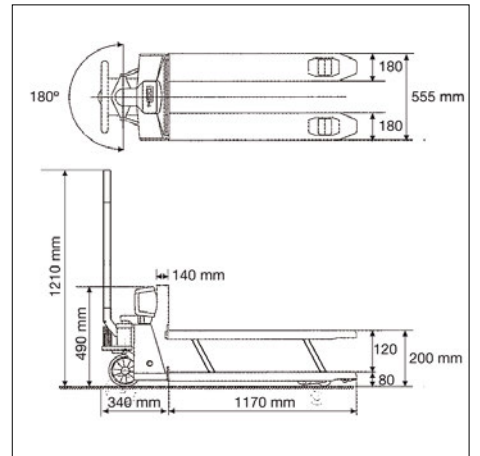

Pallet truck scale with totalising function for weights and integrated rechargeable battery pack

Features

- **PRE-TARE function** for manual deduction of a known container weight (e.g. pallet, mesh crate etc.)
- **1 Load fork:** Protection against dust and water splashes IP67, temporary use in wet areas possible
- **Pivot range 180°**
- **Castors:** Solid rubber on aluminium rims
- **3 Load rollers:** Tandem tyres to overcome thresholds and obstacles more easily
- **Check the weighing capacity which is in use** at the press of a button (net/gross weight)
- **Totalising** of weights
- Rechargeable battery pack internal, operating time up to 40 h without backlight, charging time approx. 12 h

Technical data

- **2** Backlit LCD display, digit height 22 mm
- Permissible ambient temperature -10 °C/40 °C

Accessories

- **Protective working cover**, scope of delivery: 5 items, KERN VFB-A01S05, € 40,-

Note: As standard, the unit is dispatched without the shaft and display fitted. The shaft and display can be fitted at our factory for an additional cost, delivery + 2 working days, KERN VFS-M01, € 150,-
Please state when ordering

1 Shipment via freight forwarder. Please ask for dimensions, gross weight, shipping

STANDARD

CAL EXT SUM IP 67 ACCU MULTI DMS 2 DAYS

OPTION

DAKKS +3 DAYS
seul. avec VFS-M01

Model	Weighing capacity [Max] kg	Readability [d] kg	Net weight approx. kg	Price excl. of VAT ex works €	Option	
					DAKKS KERN	Certificate €
VFB 2T-3	2000	1	110	1480,-	963-131	220,-

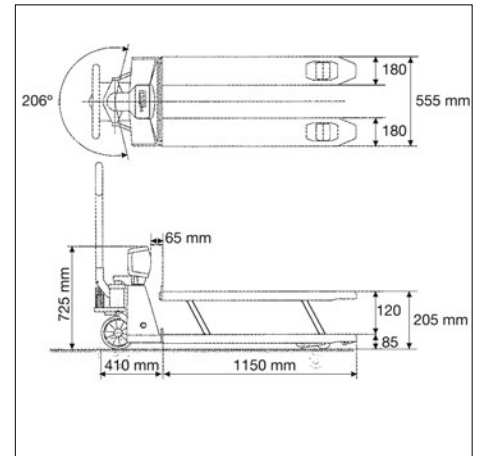

Pallet truck scale with complete protection against dust and water splashes IP65/67 and a memory for a container weight

Features

- **PRE-TARE function** for manual subtraction of a known container weight, useful for checking fill-levels
- **1 Display device:** plastic, protection against dust and water splashes IP65
- **2 Load fork:** Protection against dust and water splashes IP67, temporary use in wet areas possible
- **Pivot range 206°**
- **Castors:** Solid rubber on aluminium rims
- **3 Load rollers:** Tandem tyres to overcome thresholds and obstacles more easily
- **Totalising** of weights
- **Ready for use:** Batteries included, 4x1.5 V AA, operating time up to 80 h

Technical data

- Large LCD display, digit height 28 mm
- Permissible ambient temperature -10 °C/40 °C

Accessories

- Castors made of red polyurethane on aluminium rims. Ideal for light-coloured flooring as they leave less visible abrasive marks. Suitable for the current models of the pallet truck scale ranges KERN VHB, KERN VHS (when retrofitting, please give the serial number of the pallet truck scale available when ordering), scope of delivery: 1 item, KERN VHB-A02, € 160,-

1 Shipment via freight forwarder. Please ask for dimensions, gross weight, shipping

STANDARD

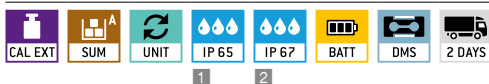

OPTION



Model	Weighing capacity	Readability	Net weight	Price excl. of VAT ex works €	Option	
					DAkkS KERN	DAkkS Calibr. Certificate €
KERN VHB 2T1	[Max] kg 2000	[d] kg 1	approx. kg 110	1310,- ↓	963-131	220,-

↓ Price reduction

Hanging scales/Crane scales

TÜV-tested safety

KERN puts great emphasis on safety. For your safety, all KERN hanging and crane scales are subject to a stringent load test in accordance with EN 13155 and (Non-fixed load lifting attachments/breakage resistance) and EN 61010-1 (Electrical safety).

New in the KERN crane scale range: Compact crane scales/load receptors/tensile dynamometers – KERN HFA and HFC.

As well as the classic crane scales, we also have electronic tensile dynamometers which are extremely versatile thanks to their stable, compact construction. They can, for example, be fitted into testing machines, used for checking for overload, for bracing and tensile force measurement, etc.

This type of device is ideally suited for use between shackles or with a test bench. This is where the benefit of this construction comes to the fore, as the tensile force can be applied in both directions. These compact crane scales are also particularly suitable when weighing suspended loads where space is tight.

At the core of this construction is a robust load cell. Through the absence of moving parts, these balances are practical in maintenance and wear free.

Note

DAkkS calibration and conformity evaluation for crane scales up to 12 t



Do you use your crane scales in ISO-certified processes or where verification is mandatory? Then we can produce the right calibration certificate or the relevant Declaration of Conformity for your measuring device. Thanks to a modern crane scale test unit, we can calibrate or verify crane scales and force-measuring devices from any manufacturer to a maximum load of up to 12 t or 120 kN. You can find all the important details on pages 206, 208 or directly from one of our test service specialists, we will be pleased to help you.



Lisa Haib

Product specialist
Hanging scales/Crane scales
Tel. +49 7433 9933-219
Fax +49 7433 9933-29219
lisa.haib@kern-sohn.com

HIGHLIGHT



from €
195,-

- Complete crane scale for lower to medium load ranges
- The massive design provides extra safety (TÜV approved)
- Large high-contrast display that is easy to read
- Shackle and the hook made of nickel-plated steel as standard

Quick-Finder Hanging scales/Crane scales

Readability [d] kg	Weighing capacity [Max] kg	Model	Price excl. of VAT ex works €	Page	DAYS	M	CAL EXT	RS 232	MOVE	IP	INOX	BATT	ACCU	For an explanation on the pictos, see the front flap									
0,005		5	HDB 5K5N	60,-	151	1		●		●			●										
0,005		6	HDB 6K-3XL	78,-	151	1																	
0,01		10	HDB 10K 10N	60,-	151	1		●		●			●										
0,01		15	HDB 10K-2XL	78,-	151	1																	
0,01		20	HCB 20K 10	105,-	152	1		●		●			●										
0,01		50	HGA 50K-2S05	80,-*	150	1																	
0,02		15	CH 15K20	69,-	151	1		●		●			●										
0,02		30	HDB 30K-2XL	78,-	151	1																	
0,02		50	HCB 50K20	115,-	152	1		●		●			●										
0,02		60	HCD 60K-2	195,-	153	1		●					●		●								
0,02 0,05		60 150	HCD 100K-2D	205,-	153	1		●					●		●								
0,05		50	CH 50K50	75,-	151	1		●		●			●										
0,05		99	HCB 99K50	100,-	152	1		●		●			●										
0,05		150	HCD 100K-2	195,-	153	1		●					●		●								
0,05		150	HFB 150K50	345,-	156	1		●															
0,05 0,1		150 300	HCD 300K-2D	205,-	153	1		●					●		●								
0,05 0,1 0,2		150 300 600	HFD 600K-1	370,-	157	1		●															
0,1		50	CH 50K 100	65,-	151	1		●		●			●										
0,1		50	HCB 50K 100	90,-	152	1		●		●			●										
0,1		50	HCN 50K 100IP	130,-	152	1		●		●	●		●										
0,1		200	HCB 200K100	115,-	152	1		●		●			●										
0,1		300	HCD 300K-1	195,-	153	1		●					●		●								
0,1		300	HFB 300K100	375,-	156	1		●															
0,1		1000	HFM 1T0.1	690,-	158	1		●															
0,1 0,2 0,5		300 600 1500	HFD 1T-4	390,-	157	1		●															
0,2		100	HCB 100K200	99,-	152	1		●		●			●										
0,2		100	HCN 100K200IP	130,-	152	1		●		●	●		●										
0,2		600	HFA 600K-1	590,-	143	1		●					●		●								
0,2		600	HFC 600K-1	990,-	155	1		●					●		●								
0,2		600	HFB 600K200	375,-	156	1		●					●		●								
0,2 0,5 1		600 1500 3000	HFD 3T-3	620,-	157	1		●															
0,5		200	HCB 200K500	95,-	152	1		●		●			●										
0,5		200	HCN 200K500IP	130,-	152	1		●		●	●		●										
0,5		1000	HFA 1T-4	690,-	143	1		●					●		●								
0,5		1000	HFC 1T-4	990,-	155	1		●					●		●								
0,5		1500	HFO 1.5T0.5M	1030,-	158	1		○															
0,5		3000	HFM 3T0.5	710,-	158	1		●															
0,5		3000	HFT 3T0.5	1210,-	159	2		●	●														
0,5		5000	HFM 5T0.5	930,-	158	1		●															
0,5 1 2		1500 3000 6000	HFD 6T-3	650,-	157	1		●															
1		500	HCB 0.5T-3	215,-	152	1		●		●			●										
1		3000	HFA 3T-3	750,-	143	1		●					●		●								
1		3000	HFC 3T-3	1050,-	155	1		●					●		●								
1		3000	HFO 3T1M	1130,-	158	1		○															
1		5000	HFT 5T1	1410,-	159	1		●	●														
1		10000	HFM 10T1	1260,-	158	1		●															
1 2 5		3000 6000 12000	HFD 10T-3	790,-	157	1		●															
2		1000	HCB 1T-3	275,-	152	1		●		●			●										
2		5000	HFA 5T-3	790,-	143	1		●					●		●								
2		5000	HFC 5T-3	1090,-	155	1		●					●		●								
2		6000	HFO 6T2M	1400,-	158	1		○															
2		10000	HFT 10T2	1720,-	159	2		●	●														
5		10000	HFA 10T-3	1050,-	143	1		●					●		●								
5		10000	HFC 10T-3	1370,-	155	1		●					●		●								
5		15000	HFT 15T5	2520,-	159	2		●	●				●		●								

News 2019

* Price set of 5 units

● = standard ○ = option



Ultra compact, digital luggage scale for rapid weighing of items of luggage and other suspended loads

Features

- This ergonomically-optimised luggage scale is perfectly suited for rapid, accurate checking of cases, bags, sports baggage, etc. The high maximum load means that there is sufficient safety reserve and can therefore also be used for weighing other, suspended loads
- **1** With the **TÜV certification mark**, the scale meets the requirements of the standard EN 13155 (Non-fixed load lifting attachments/ Breakage resistance) and EN 61010-1 (Electrical safety)

- **2** Ergonomic design for easy handling
- Robust nylon fabric tape for secure fixing of the item to be weighed
- **Simple and convenient 1-key operation**
- Easy to toggle between units by a keypress
- **High mobility:** thanks to battery operation, compact, lightweight construction, it is suitable for the use in several locations
- Automatic Hold function: When the weighing value remains unchanged the weight indicated on the display is automatically “frozen” for 12 s. This leaves sufficient time to read the weight in peace

Technical data

- Backlit LCD display, digit height 9 mm
- Ready for use: Batteries included, 3V CR2032, operating time up to 20 h, AUTO-OFF function to preserve the battery, Battery level indicator on display
- **Note:** The models are only delivered in a set of 5 units. i.e. the price given in the table refers to a delivery of 5 items. Cannot be delivered individually. The calibration prices given here refer to calibration of a single balance



Model	Weighing capacity [Max] kg	Readability [d] g	Dimensions housing W×D×H mm	Net weight approx. kg	Delivery quantity	Price excl. of VAT ex works €	Option		Delivery quantity
							DAkkS Calibr. Certificate		
							DAkkS KERN	€	
HGA 50K-2S05	50	10	150×31×35	1,6	5	80,-	963-128	88,-	1



KERN HDB-N



KERN HDB-XL



KERN CH

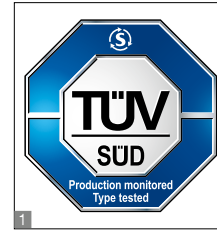

Convenient, economical and always handy
- NEW: high-capacity XL-version

Features

- KERN HDB-XL: high-capacity XL-version. The larger design creates space for a large handle, which enables even better handling especially with heavier loads
- **1** With the **TÜV certification mark**, the scales meet the requirements of the standard EN 13155 (Non-fixed load lifting attachments/ Breakage resistance) and EN 61010-1 (Electrical safety)
- Ideal for rapid control in goods-in and goods-out
- Also essential in the private sector to determine the weight of fish, game, fruits, bicycle parts, suitcases etc.
- **Hold function:** For easy reading of the weighing result, the display can be “frozen” in different ways. Either automatically when the weighing value remains unchanged or manually by pressing the Hold key

- **Hook, steel**, can be hinged (HDB-N, HDB-XL)
- **Peak load display** (peak hold)

Technical data

HDB-N/HDB-XL

- LCD display, digit height 12 mm
- **Ready for use:** Batteries included, 2×1.5 V AAA, operating time up to 180 h
- Further weighing units: kg, lb, N
- Permissible ambient temperature 5 °C/35 °C

CH

- LCD display, digit height 11 mm
- **2 Tape measure**, extractable, length approx. 100 cm
- Ready for use: Batteries included, 9 V block, operating time up to 20 h
- Further weighing units: kg, lb, N
- Permissible ambient temperature 5 °C/35 °C

Accessories

- **3 Tare pan with pan beam**, details see Accessories, KERN CH-A01N, € 70,-

STANDARD						OPTION	
CAL EXT	UNIT	MOVE	BATT	DMS	1 DAY	+3 DAYS	

Model	Weighing capacity [Max] kg	Readability [d] kg	Dimensions housing W×D×H mm	Net weight approx. kg	Price excl. of VAT ex works €	Option DAkkS Calibr. Certificate	
						DAkkS KERN	€
KERN							
HDB 5K5N	5	5	72×25×105	0,20	60,-	963-127H	72,-
HDB 10K10N	10	10	70×25×105	0,45	60,-	963-128H	88,-
HDB 6K-3XL	6	5	107×25×101	0,20	78,-	963-128H	88,-
HDB 10K-2XL	15	10	107×25×101	0,20	78,-	963-128H	88,-
HDB 30K-2XL	30	20	107×25×101	0,20	78,-	963-128H	88,-
CH 15K20	15	20	90×30×176,5	0,35	69,- ↓	963-128H	88,-
CH 50K50	50	50	90×30×176,5	0,35	75,- ↓	963-128H	88,-
CH 50K100	50	100	90×30×176,5	0,35	65,- ↓	963-128H	88,-

↓ Price reduction



KERN HCB



KERN HCN

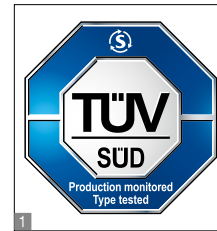

The handy scales for higher loads up to 1 t

Features

- With the **TÜV certification mark**, the scales meet the requirements of the standard EN 13155 (Non-fixed load lifting attachments/ Breakage resistance) and EN 61010-1 (Electrical safety)
- Ideal for rapid control in goods-in and goods-out
- Also essential in the private sector to determine the weight of fish, game, fruits, bicycle parts, suitcases etc.
- Hold function:** For easy reading of the weighing result, the display can be “frozen” in different ways. Either automatically when the weighing value remains unchanged or manually by pressing the Hold key
- Peak load display** (peak hold), Measuring frequency 5 Hz

Technical data

- LCD display, digit height 12 mm
- Hole diameter of load support, model with [Max] ≤ 200 kg: approx. 14 mm
- [Max] > 200 kg: approx. 16 mm

HCB

- Ready for use:** Batteries included, 3×1.5 V AA, operating time up to 300 h
- [Max] ≥ 0,5 t: Reinforced version for heavy loads. Snap link and Hook not included

HCN

- Housing stainless steel, stainless steel, IP65-protected against dust and water splashes
- Second display** on the rear of the balance
- Ready for use: Batteries included, 2×1.5 V AA, operating time up to 200 h

Accessories

- Accessories for models with [Max] ≤ 20 kg**
- Tare pan with pan beam**, details see *Accessories*, KERN CH-A01N, € 70,-
- Accessories for models with [Max] ≥ 100 kg**
- Hook with safety catch**, cast steel, galvanised and lacquered, revolving. Scope of delivery: 2 shackles, 1 lacquered screw bolt, 1 hook, KERN YHA-06, € 125,-
- Accessories for models with [Max] ≤ 200 kg**
- Snap link (stainless steel) with safety catch**, standard, opening approx. 15 mm. Can be reordered, KERN HCB-A01, € 33,-
- Hook (stainless steel)**, standard, opening approx. 25 mm. Can be reordered, KERN HCB-A02, € 30,-
- Accessories for models with [Max] ≥ 0,5 t**
- High-strength shackle**, hot-dipped galvanised cast steel bracket, bow shaped. Scope of delivery: 2 shackles with lacquered screw bolts, suitable for models KERN HCB with [Max] ≥ 0,5 t, KERN YSC-03, € 50,-

STANDARD

CAL EXT UNIT MOVE IP 65 INOX BATT 1 DAY

OPTION

DAKKS +3 DAYS

Model	Weighing capacity [Max] kg	Readability [d] g	Dimensions housing W×D×H mm	Net weight approx. kg	Price excl. of VAT ex works €	Option	
						DAKKS KERN	Certificate €
KERN							
HCB 20K10	20	10	80×45×150	0,60	105,-	963-128H	88,-
HCB 50K20	50	20	80×45×150	0,60	115,-	963-128H	88,-
HCB 50K100	50	100	80×45×150	0,60	90,-	963-128H	88,-
HCB 99K50	99	50	80×45×150	0,60	100,-	963-129H	105,-
HCB 100K200	100	200	80×45×150	0,60	99,-	963-129H	105,-
HCB 200K100	200	100	80×45×150	0,60	115,-	963-129H	105,-
HCB 200K500	200	500	80×45×150	0,60	95,-	963-129H	105,-
HCB 0.5T-3	500	1000	80×42×152	0,30	215,-	963-130H	165,-
HCB 1T-3	1000	2000	80×48×150	0,30	275,-	963-130H	165,-
Stainless steel							
HCN 50K100IP	50	100	95×50×180	0,80	130,-	963-128H	88,-
HCN 100K200IP	100	200	95×50×180	0,80	130,-	963-129H	105,-
HCN 200K500IP	200	500	95×50×180	0,80	130,-	963-129H	105,-

Price reduction



NEW



High-resolution hanging scale for loads up to 300 kg

Features

- **NEW: Fully-equipped crane scale** for low to medium load ranges. The solid design guarantees that extra level of safety (TÜV tested). Thanks to the large LCD display and the remote control which is delivered as standard, it can also be operated safely from a distance and results can be read off
- **1** With the **TÜV certification mark**, the scale meets the requirements of the standard EN 13155 (Non-fixed load lifting attachments/ Breakage resistance) and EN 61010-1 (Electrical safety)
- **High mobility:** thanks to battery operation, compact, lightweight construction, it is suitable for the use in several locations (production, warehouse, dispatch department etc.)
- **Hold function:** When the weighing value remains unchanged the weight indicated on the display is automatically “frozen” until the Hold key is pressed

- **Tare:** Resets the display to “0” when there is a load on the scale. Now removed or added loads are directly displayed
- Batterie charge status indication visualised through LED
- Large high-contrast display that is easy to read
- Standby function: display automatically switched off after 5 min without a change of load. Automatic activation with the touch of a key
- **Hook with safety catch**, revolving
- Shackle and safety catch made of nickel-plated steel
- **2** **Infrared remote control** standard. Range up to 20 m. All functions can be selected. W×D×H 65×24×100 mm. Batteries included

Technical data

- LCD display, digit height 28 mm
- Batteries included, 4×1.5 V AA, operating time up to 100 h
- Precision: 0,2 % of [Max]
- Permissible ambient temperature 5 °C/35 °C

STANDARD					OPTION	
CAL EXT	UNIT	BATT	DMS	1 DAY	DAkKS	+3 DAYS

Model	Weighing capacity [Max] kg	Readability [d] g	Net weight approx. kg	3 Dimensions							Price excl. of VAT ex works €	Option	
				A mm	B mm	C mm	D mm	E mm	F mm	G mm		DAkKS Calibr. Certificate	€
KERN HCD 60K-2	60	20	0,85	194	79,3	97,7	276,5	246,5	26	23,5	195,-	963-129H	105,-
KERN HCD 100K-2	150	50	0,85	194	79,3	97,7	276,5	246,5	26	23,5	195,-	963-129H	105,-
KERN HCD 300K-1	300	100	0,85	194	79,3	97,7	276,5	246,5	26	23,5	195,-	963-129H	105,-
Dual-range balance switches automatically to the next largest weighing capacity [Max] and readability [d]													
KERN HCD 100K-2D	60 150	20 50	0,85	194	79,3	97,7	276,5	246,5	26	23,5	205,-	963-129H	105,-
KERN HCD 300K-2D	150 300	50 100	0,85	194	79,3	97,7	276,5	246,5	26	23,5	205,-	963-129H	105,-

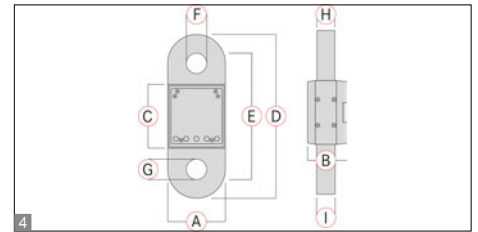
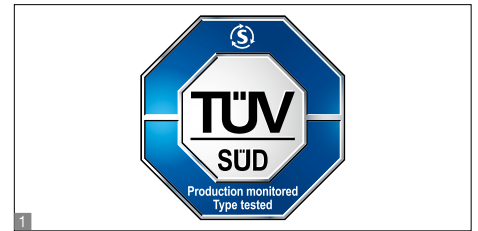

Compact crane scale with integrated display can also be used for tensile force measurement

Features

- **1** With the **TÜV certification mark**, the scale meets the requirements of the standard EN 13155 (Non-fixed load lifting attachments/ Breakage resistance) and EN 61010-1 (Electrical safety)
- With its high-quality finish, low weight and compact dimensions, this crane scale (tensile force gauge) is an essential device for industrial use, on building sites, in freight centres, ports etc.
- Because of its compact design it is also ideally suited for installation in systems where space is limited, etc.
- Ideally suited for determining weight quickly while loading and unloading
- **Peak load display** (peak hold)
- **Hold function:** For easy reading of the weighing result, the display can be “frozen” in different ways. Either automatically when the weighing value remains unchanged or manually by pressing the Hold key

- **Tare:** Resets the display to “0” when there is a load on the scale. Now removed or added loads are directly displayed

Technical data

- Large backlit LCD display, digit height 23 mm
- Material and design of housing/load support, models with [Max] ≤ 3 t: aluminium/stainless steel bearing [Max] > 3 t: steel/steel
- Rechargeable battery pack internal, operating time up to 30 h without backlight, charging time approx. 12 h
- Optional battery operation, 3×1.5 V AA not included, operating time up to 40 h
- Precision: 0,2 % of [Max]
- Measuring frequency 60 Hz
- Further weighing units: kg, lb, N
- Permissible ambient temperature 5 °C/35 °C

Accessories

- **2 High-strength shackle**, hot-dipped galvanised cast steel bracket, bow shaped. Scope of delivery: 2 shackles with lacquered screw bolts, suitable for models with [Max] ≤ 5 t: KERN YSC-01, **€ 100,-** [Max] > 5 t: KERN YSC-02, **€ 210,-**
- **3 Hook with safety catch**, cast steel, galvanised and lacquered, non-revolving. Scope of delivery: 2 shackles, 1 lacquered screw bolt, 1 hook, suitable for models with [Max] ≤ 1 t: KERN YHA-01, **€ 170,-** [Max] = 3 t: KERN YHA-02, **€ 190,-** [Max] = 5 t: KERN YHA-03, **€ 230,-** [Max] > 5 t: KERN YHA-04, **€ 410,-**

15

STANDARD

CAL EXT UNIT BATT ACCU MULTI DMS 1 DAY

OPTION

DAKKS +3 DAYS

Model	Weighing capacity [Max] kg	Readability [d] g	Net weight approx. kg	4 Dimensions					Price excl. of VAT ex works €	Option	
				A	B	C	D	F		DAKKS KERN	Calibr. Certificate €
				mm	mm	mm	mm	mm			
KERN HFA 600K-1	600	200	1,8	90	30	55	255	27	590,-	963-130H	165,-
HFA 1T-4	1000	500	1,8	90	30	55	255	27	690,-	963-130H	165,-
HFA 3T-3	3000	1000	2,0	90	30	61	255	27	750,-	963-132H	500,-
HFA 5T-3	5000	2000	4,0	90	30	61	255	30	790,-	963-132H	500,-
HFA 10T-3	10000	5000	6	90	40	71	275	40	1050,-	963-133H	700,-

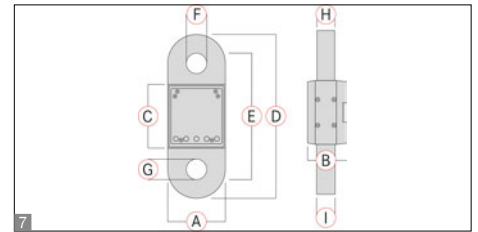
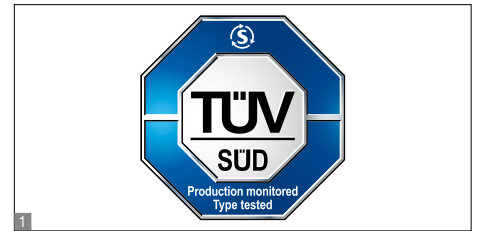

Compact crane scale for use in harsh environmental conditions or where space is limited, with convenient hand-held terminal

Features

- **1** With the **TÜV certification mark**, the scale meets the requirements of the standard EN 13155 (Non-fixed load lifting attachments/ Breakage resistance) and EN 61010-1 (Electrical safety)
- With its high-quality finish, low weight and compact dimensions, this crane scale (tensile force gauge) is an essential device for industrial use, on building sites, in freight centres, ports etc.
- Because of its compact design it is also ideally suited for installation in systems where space is limited, etc.
- **Peak load display** (peak hold)
- **Hold function:** When the weighing value remains unchanged the weight indicated on the display is automatically “frozen” until the Hold key is pressed
- **Tare:** Resets the display to “0” when there is a load on the scale. Now removed or added loads are directly displayed

- **2 Display device with integrated radio module**, which the user can carry around with him, thanks to the convenient hand strap **3**, standard. In this way the weighing data can always be read off the display device by the user, even when the user is a long way from the load receptor (force gauge) or under poor lighting conditions. Range up to 100 m, LCD display, digit height 23 mm, rechargeable battery pack internal, standard. Operating time up to 30 h without backlight, charging time approx. 12 h. Can be reordered, KERN HFC-A01, **€ 60,-**
- Dimensions housing (display device) WxDxH 88x64x256 mm
- Net weight 0,4 kg

Technical data

- Large backlit LCD display, digit height 23 mm
- Material and design of housing/load support, models with
[Max] ≤ 3 t: aluminium/stainless steel bearing
[Max] > 3 t: steel/steel

- Optional battery operation, 3x1.5 V AA not included, operating time up to 40 h
- Precision: 0,2 % of [Max]
- Measuring frequency 60 Hz
- Further weighing units: kg, lb, N
- Permissible ambient temperature 5 °C/35 °C

Accessories

- **4 Rechargeable battery pack internal** for load support, operating time up to 30 h, without backlight, charging time approx. 12 h, KERN HFA-A01, **€ 40,-**
- **5 High-strength shackle**, hot-dipped galvanised cast steel bracket, bow shaped. Scope of delivery: 2 shackles with lacquered screw bolts, suitable for models with [Max] ≤ 5t: KERN YSC-01, **€ 100,-** [Max] > 5t: KERN YSC-02, **€ 210,-**
- **6 Hook with safety catch**, cast steel, galvanised and lacquered, non-revolving. Scope of delivery: 2 shackles, 1 lacquered screw bolt, 1 hook, suitable for models with [Max] ≤ 1t: KERN YHA-01, **€ 170,-** [Max] = 3t: KERN YHA-02, **€ 190,-** [Max] = 5t: KERN YHA-03, **€ 230,-** [Max] > 5t: KERN YHA-04, **€ 410,-**

STANDARD

CAL EXT UNIT BATT ACCU MULTI DMS 1 DAY

load receptors only

OPTION

ACCU DAKKS +3 DAYS

Model	Weighing capacity [Max] kg	Readability [d] g	Net weight approx. kg	7 Dimensions					Price excl. of VAT ex works €	Option	
				A	B	C	D	F		DAkKS KERN	Calibr. Certificate €
				mm	mm	mm	mm	mm			
KERN HFC 600K-1	600	200	1,8	90	30	55	255	27	990,-	963-130H	165,-
KERN HFC 1T-4	1000	500	1,8	90	30	55	255	27	990,-	963-130H	165,-
KERN HFC 3T-3	3000	1000	2,2	90	30	61	255	27	1050,-	963-132H	500,-
KERN HFC 5T-3	5000	2000	4,0	90	30	61	255	30	1090,-	963-132H	500,-
KERN HFC 10T-3	10000	5000	6	90	40	71	275	40	1370,-	963-133H	700,-

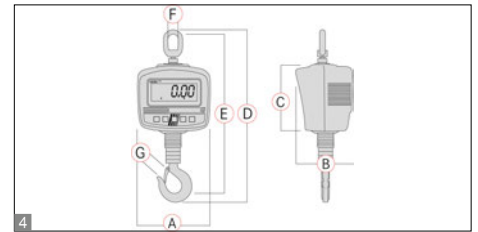
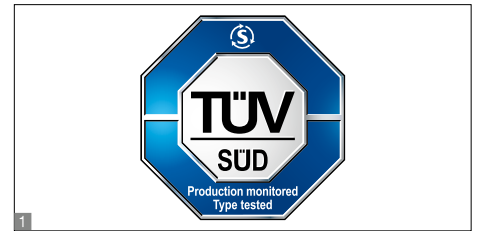

The professional alternative up to 600 kg with rear-facing second display

Features

- **1** With the **TÜV certification mark**, the scale meets the requirements of the standard EN 13155 (Non-fixed load lifting attachments/ Breakage resistance) and EN 61010-1 (Electrical safety)
- **2 Second display** on the rear of the balance
- **High mobility:** thanks to rechargeable battery operation, compact, lightweight construction, it is suitable for the use in several locations (production, warehouse, dispatch department etc.)
- **Hold function:** When the weighing value remains unchanged the weight indicated on the display is automatically "frozen" until the Hold key is pressed

- **Tare:** Resets the display to "0" when there is a load on the scale. Now removed or added loads are directly displayed
- **Hook with safety catch**, revolving
- Shackle and safety catch made of nickel-plated steel
- **3 Radio remote control** standard. Range up to 20 m. All functions can be selected (excl. ON/OFF). W×D×H 48×10×95 mm. Batteries included, 2×1.5 V AAA

Technical data

- **Superior display size:** digit height 25 mm, bright backlight for easy reading of weighing results, even in poor lighting conditions
- Display device
- Dimensions housing W×D×H 162×123×390 mm
- Rechargeable battery pack internal, operating time up to 30 h without backlight, charging time approx. 14 h
- Precision: 0,2 % of [Max]
- Permissible ambient temperature 0 °C/40 °C

STANDARD

CAL EXT UNIT ACCU MULTI DMS 1 DAY

OPTION

DAkkS +3 DAYS

Model	Weighing capacity [Max] kg	Readability [d] g	Net weight approx. kg	4 Dimensions							Price excl. of VAT ex works €	Option	
				A mm	B mm	C mm	D mm	E mm	F mm	G mm		DAkkS KERN	DAkkS Calibr. Certificate €
KERN HFB 150K50	150	50	2,2	163	126	158,5	390	358	26	25	345,-	963-129H	105,-
KERN HFB 300K100	300	100	2,2	163	126	158,5	390	358	26	25	375,-	963-129H	105,-
KERN HFB 600K200	600	200	2,4	163	126	158,5	390	358	26	25	375,-	963-130H	165,-

Price reduction

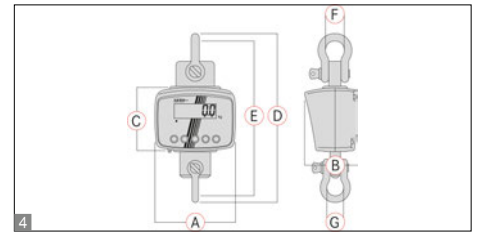
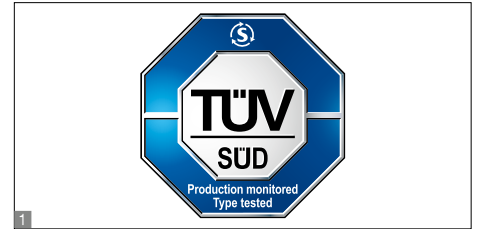

Robust, high-resolution crane scale up to 12 t

Features

- **1** With the **TÜV certification mark**, the scales meet the requirements of the standard EN 13155 (Non-fixed load lifting attachments/ Breakage resistance) and EN 61010-1 (Electrical safety)
- **Because of its stable construction and robust design**, it is ideal for continuous use in industrial environment
- **High mobility:** thanks to rechargeable battery operation, compact, lightweight construction, it is suitable for the use in several locations (production, warehouse, dispatch department etc.)
- **Hold function:** When the weighing value remains unchanged the weight indicated on the display is automatically “frozen” until the Hold key is pressed

- **Tare:** Resets the display to “0” when there is a load on the scale. Now removed or added loads are directly displayed
- **Solid shackles**, non-revolving
- **2 Radio remote control** standard. Range up to 20 m. All functions can be selected (excl. ON/OFF). W×D×H 65×24×100 mm. Batteries included, 1× 12 V 23A

Technical data

- **Superior display size:** digit height 30 mm, bright backlight for easy reading of weighing results, even in poor lighting conditions
- Rechargeable battery pack internal, operating time up to 70 h, battery pack accessible from the outside, which means it is easy to replace
- Precision: 0,2 % of [Max]
- Permissible ambient temperature -10 °C/40 °C

Accessories

- **Rechargeable battery pack internal** for load support, operating time up to 70 h, without backlight, charging time approx. 12 h, KERN HFD-A04, **€ 65,-**
- **3 Hook with safety catch**, cast steel, galvanised and lacquered, non-revolving, suitable for models
HFD 600, HFD 1T: KERN HFD-A01, **€ 40,-**
HFD 3T: KERN HFD-A02, **€ 55,-**
HFD 6T: KERN HFD-A03, **€ 95,-**
HFD 10T, HFD 12T: KERN HFD-A05, **€ 125,-**

STANDARD					OPTION	
CAL EXT	ACCU	MULTI	DMS	1 DAY	DAkKS	+3 DAYS

Model	Weighing capacity [Max] kg	Readability [d] g	Net weight approx. kg	4 Dimensions						Price excl. of VAT ex works €	Option	
				A mm	B mm	C mm	D mm	E mm	F = G mm		DAkKS KERN	Certificate €
Triple range balance switches automatically to the next largest weighing capacity [Max] and readability [d]												
HFD 600K-1	150 300 600	50 100 200	9	194	129	145	421	383	50,8	370,-	963-130H	165,-
HFD 1T-4	300 600 1500	100 200 500	9	194	129	145	421	383	50,8	390,-	963-130H	165,-
HFD 3T-3	600 1500 3000	200 500 1000	10	194	129	145	421	383	50,8	620,-	963-132H	500,-
HFD 6T-3	1500 3000 6000	500 1000 2000	15	194	129	145	477	426	68,3	650,-	963-132H	500,-
HFD 10T-3	3000 6000 12000	1000 2000 5000	20	194	129	145	573	510	82,5	790,-	963-133H	700,-



KERN HFM



KERN HFO

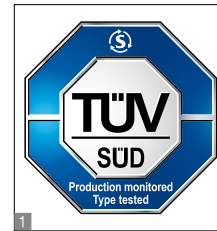

1



2

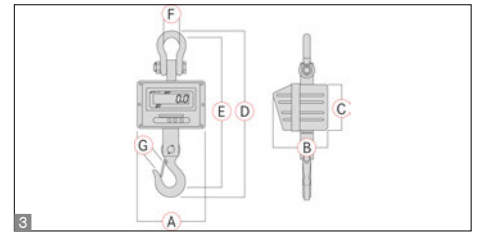

3

Industrial crane scale up to 10 t – with EC type approval [M]

Features

- **1** With the **TÜV certification mark**, the scales meet the requirements of the standard EN 13155 (Non-fixed load lifting attachments/ Breakage resistance) and EN 61010-1 (Electrical safety)
- Professional device for robust applications in production, quality control, logistics etc. Because of its stable construction and robust design, it is ideal for continuous use in industrial environment
- **High mobility:** thanks to rechargeable battery operation, compact, lightweight construction, it is suitable for the use in several locations (production, warehouse, dispatch department etc.)
- **Adaptation to unstable environmental conditions** by changing the readability

- **High resolution readability:** Readability [d] for 5 sec increased by one decimal place at the touch of a key, only for models with EC type approval
- **Hold function:** When the weighing value remains unchanged the weight indicated on the display is automatically “frozen” until the Hold key is pressed
- **Tare:** Resets the display to “0” when there is a load on the scale. Now removed or added loads are directly displayed
- **Hook with safety catch**, revolving
- **2 Radio remote control** standard. Range up to 20 m. All functions can be selected (excl. ON/OFF). W×D×H 48×10×95 mm. Batteries included, 2×1.5 V AAA

Technical data

- Superior display size: digit height 30 mm, bright with high contrast for easy reading of weighing results, even in poor lighting conditions
- Rechargeable battery pack internal, operating time up to 50 h without backlight, charging time approx. 14 h
- Precision: 0,2 % of [Max]
- Permissible ambient temperature 0 °C/40 °C

STANDARD

CAL EXT ACCU MULTI DMS 1 DAY

OPTION

DAKKS +3 DAYS

FACTORY

M +3 DAYS HFO

Model	Weighing capacity [Max] kg	Readability [d] g	Net weight approx. kg	3 Dimensions							Price excl. of VAT ex works €	Option			
				A mm	B mm	C mm	D mm	E mm	F mm	G mm		Verification		DAKKS Calibr. Certificate	
												M III KERN	€	DAKKS KERN	€
HFM 1T0.1	1000	100	14	270	175	200	610	540	68	40	690,-	-	-	963-130H	165,-
HFM 3T0.5	3000	500	16	270	175	200	610	540	74	40	710,-	-	-	963-132H	500,-
HFM 5T0.5	5000	500	24	300	190	230	730	650	74	55	930,-	-	-	963-132H	500,-
HFM 10T1	10000	1000	34	300	190	230	840	750	92	60	1260,-	-	-	963-133H	700,-
Note: For applications that require verification, please order verification at the same time, initial verification at a later date is not possible.															
Verification at the factory, we need to know the full address of the location of use.															
HFO 1.5T0.5M	1500	500	16	270	175	200	610	540	60	35	1030,-	965-130H	132,-	963-130H	165,-
HFO 3T1M	3000	1000	17	270	175	200	610	540	80	47	1130,-	965-132H	200,-	963-132H	500,-
HFO 6T2M	6000	2000	30	300	190	230	730	650	80	54,4	1400,-	965-132H	200,-	963-132H	500,-

Price reduction

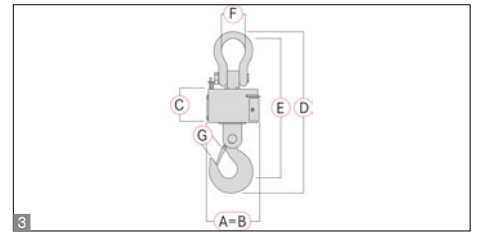
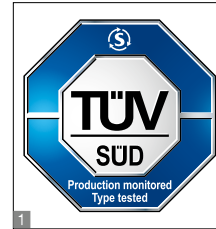

Robust industrial crane scale up to 15 t with radio display and RS-232 data interface for transferring weighing results

Features

- **1** With the **TÜV certification mark**, the scales meet the requirements of the standard EN 13155 (Non-fixed load lifting attachments/ Breakage resistance) and EN 61010-1 (Electrical safety)
- Professional device for robust applications in production, quality control, logistics etc. Because of its stable construction and robust design, it is ideal for continuous use in industrial environment
- **Load receptor without display**, therefore very robust
- **Hold function:** When the weighing value remains unchanged the weight indicated on the display is automatically “frozen” until the Hold key is pressed
- **Hook with safety catch**, revolving

- **2 Display with integrated radio module**, in this way the weighing data can easily be read off the display by the user, even if the user might find himself in a remote distance from the crane scale. Range up to 20 m. The integrated RS-232 data interface allows from connection to a printer, PC or network
- Internal rechargeable battery pack for load receptor and display device included with the delivery

Technical data

- Separate display with large, backlit LCD display, digit height 22 mm. Dimensions W×D×H 175×50×85 mm, incl. Antenna W×D×H 130×650×130 mm
- Precision: 0,2 % of [Max]
- Permissible ambient temperature 0 °C/40 °C

Accessories

- Load receptor: **Rechargeable battery pack internal**, operating time up to 80 h without backlight, charging time approx. 8 h, KERN VFB-A02, **€ 50,-**
- Display device: **Rechargeable battery pack internal**, operating time up to 80 h without backlight, charging time approx. 8 h, KERN GAB-A04, **€ 40,-**
- **Interface cable RS-232**, to connect the display device to a printer, PC, etc., cable length approx.1,5 m, KERN KFF-A01, **€ 46,-**
- Further details, plenty of further accessories and suitable printers see *Accessories*

STANDARD



OPTION



Model	Weighing range [Max] kg	Readability [d] g	Net weight approx. kg	3 Dimensions						Price excl. of VAT ex works €	Option DAKKS Calibr. Certificate	
				A = B mm	C mm	D mm	E mm	F mm	G mm		DAKKS KERN	€
HFT 3T0.5	3000	500	28	270	145	650	545	73	39	1210,-	963-132H	500,-
HFT 5T1	5000	1000	34	270	147	760	635	76	51	1410,-	963-132H	500,-
HFT 10T2	10000	2000	42	270	167	840	735	92	61	1720,-	963-133H	700,-
HFT 15T5	15000	5000	75	320	160	950	842	99	61	2520,-	963-133H	700,-

ONLY WHILE STOCKS LAST

Price reduction

16

Accessories

Printers



Second display



Weighing table



Ioniser



Stands



Interface adapter



Printers



STANDARD

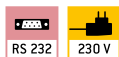

STANDARD

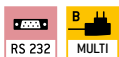

STANDARD



Important note for printer orders:

Please state your balance model when ordering, so that the printer can be preconfigured in the factory to suit your balance.

Matrix needle printer KERN 911-013

For printing weighing results on normal paper, which is ideal for long-term archiving.

Matrix needle printer KERN YKN-01

For printing weighing results on normal paper, which is ideal for long-term archiving.

Thermal printer KERN YKB-01N

For printing weighing results, recipes, quantities etc. or for GLP record keeping of balance adjustment with date and time print. FLP / GMP compliant print form available as standard. Language versions: DE, GB, FR.

Technical data

- Needle print
- Speed: 1,8 line/s
- Max. 40 characters per line
- Paper stripes: 57 mm wide
- Operation via mains adapter 230 V/50 Hz (standard EU), as standard
- Dimensions housing: W×D×H 100×180×106 mm
- Not suitable for KERN PNS/PNJ, PES/PEJ ranges
- Interface cable not included with delivery

Price printer without interface cable,
KERN 911-013, € 390,-

Accessories

- Paper rolls (10 pcs.), KERN 911-013-010, € 35,-
- Universal mains adapter, standard EU/GB/US, KERN ABS-A01, € 80,-

Technical data

- Needle print
- Speed: 1 line/s
- Max. 16 characters per line
- Paper stripes: 44 mm wide
- Operation via mains adapter 230 V/50 Hz (standard EU/GB/USA), as standard
- Dimensions housing: W×D×H 158×106×40 mm
- Interface cable not included with delivery

Price printer without interface cable,
KERN YKN-01, € 230,-

Accessories

- Paper rolls (5 pcs.), KERN YKN-A01, € 35,-

Technical data

- Thermal print
- Speed: 0,75 lines/s
- Max. 40 characters per line
- Paper stripes: 112 mm wide
- Operation via mains adapter 230 V/50 Hz (standard EU/GB/USA), as standard
- Dimensions housing: W×D×H 165×140×50 mm
- Interface cable not included with delivery

Price printer without interface cable,
KERN YKB-01N, € 320,-

Accessories

- Paper rolls (10 pcs.), KERN YKB-A10, € 55,-

Individual header data:

For printers **KERN 911-013, YKN-01, YKB-01N, YKE-01 and YKC-01 (in combination with YKI-02)** the free software **KERN SHM-01** (see www.kern-sohn.com) can be used to print 4 header lines on the printout (see marking on balance). Compatible models: KERN 440, DE, FCB, FKB-A, PCB, PCD.

Printers



STANDARD



STANDARD



Important note for printer orders:

Please state your balance model when ordering, so that the printer can be preconfigured in the factory to suit your balance.

Thermal statistics printer KERN YKS-01

For printing weighing results, recipes etc. or for GLP record keeping of weighing data with date and time print (not in combination with KERN counting scales or KERN moisture analysers). Numerator; with statistical functions such as count and total of all measurements, minimum and maximum values of the main unit, range, average value, standard deviation, available units: mg, g, kg, pcs. Language versions: DE, GB, FR.

Technical data

- Thermal print
- Speed: 0,75 lines/s
- Max. 40 characters per line
- Paper stripes: 112 mm wide
- Operation via mains adapter 230 V/50 Hz (standard EU/GB/USA), as standard
- Dimensions housing:
W×D×H 165×140×50 mm
- Interface cable not included with delivery
- Not suitable for KERN PFB range

Price printer without interface cable,
KERN YKS-01, **€ 390,-**

Accessories

Paper rolls (10 pcs.), KERN YKB-A10, **€ 55,-**

Thermal label printer KERN YKE-01

Affordable universal label printer to print out weighing results on thermal labels, compatible with all KERN 2019 balances. ASCII-capable.

Technical data

- Thermal print
- Speed: 22 mm/s
- Max. 82 characters per line
- Paper stripes: 112 mm wide
- Operation via mains adapter 230 V/50 Hz (standard EU/GB/USA), as standard
- Dimensions housing:
W×D×H 150×155×65 mm
- Interface cable not included with delivery
- Not suitable for KERN CPB, RPB, CFS, IFS, CCS, BFS, KFS-TM ranges

Price printer without interface cable,
KERN YKE-01, **€ 590,-**

Accessories

- Paper roll (1 pc.), Dimensions labels:
W×D 73×61 mm, 100 labels,
KERN YKE-A02, **€ 30,-**
W×D 105×48 mm, 45 labels:
KERN YKE-A03, **€ 30,-**

Individual header data:

For printers **KERN 911-013, YKN-01, YKB-01N, YKE-01 and YKC-01 (in combination with YKI-02)** the free software **KERN SHM-01** (see www.kern-sohn.com) can be used to print 4 header lines on the printout (see marking on balance). Compatible models: KERN 440, DE, FCB, FKB-A, PCB, PCD.

Interface cable for RS-232

For direct connection to a printer or PC, cable length approx. 1.5 m.
The interface parameters can be set using the balance keypad.

Note

The interface cable is **free of charge** if you purchase balance, printer or Ethernet-/WLAN-/Bluetooth adapter together.

Printer, ...	PC, YKI-01/-02/-03	911-013, YKE-01, YKB-01N, YKN-01	YKS-01	Price/cable excl. of VAT ex works €
Balance	KERN	KERN	KERN	
440, 572, 573, ALJ-AM, ALS-A, ALT-B, CDS, CKE, DE-D, DS, EMB-V, FCB, FKA, FKB, FKC, FKB-A, FKT, FKTF, IKT, KB, PCB, PCD, PKS, PKT, PLJ-A, PLJ-F, PLS-A, PLS-F, PLE, PLT, KDP	572-926			46,-
DAB, DBS, DLB, DLT	572-926			
YKV-01, KGP	572-926	-	-	
EOC, IOC, BID, KIB-T, KIB-TM	EOC-A12			
BFA, BFB, BFN (until year of construction 2019), GAB-N, GAB-P, GAT, IFB, KFB-TM, KFN-TM, NBB, NFB, NFN (until year of construction 2019) PFB, SFB, UFA, UFB, UFC, UFN	CFS-A01			
BFS, CCS, CFS, CPB, EWJ, KFG-TM, KFS-TM, KFT-TM, IFG, IFS (from year of production 2015), IFT, PFB, PFB-M, RPB	CFS-A01		-	
ABT-NM, PBJ, PBS	770-926			
HFT	KFF-A01			
EG-N, EW-N	474-926			
ADB, AEJ-CM, AEJ-NM, AES-C, AES-N, AET, CCP, CCT (for connecting the peripheral device to the PLJ-C reference balance), ILJ-C, ILS-C, ILT, PET, PLJ-C, PLJ-G, PNJ, PNS, PEJ, PES (printer/PC connection bidirectional)	MLB-A05			
HFT	KFF-A01			
ABP, KFS-T, MLS-D	MLB-A05		-	
ABJ-NM, ABS-N	ACS-A01			
BAN, BKN, BXS, IXS, KXS-TM, SXS	KXS-A04 (Factory Option)			
CCT (for connecting the peripheral device to the bulk scale ILT)	KET-A09			

With products from KERN you are ready to face the challenges of Industry 4.0

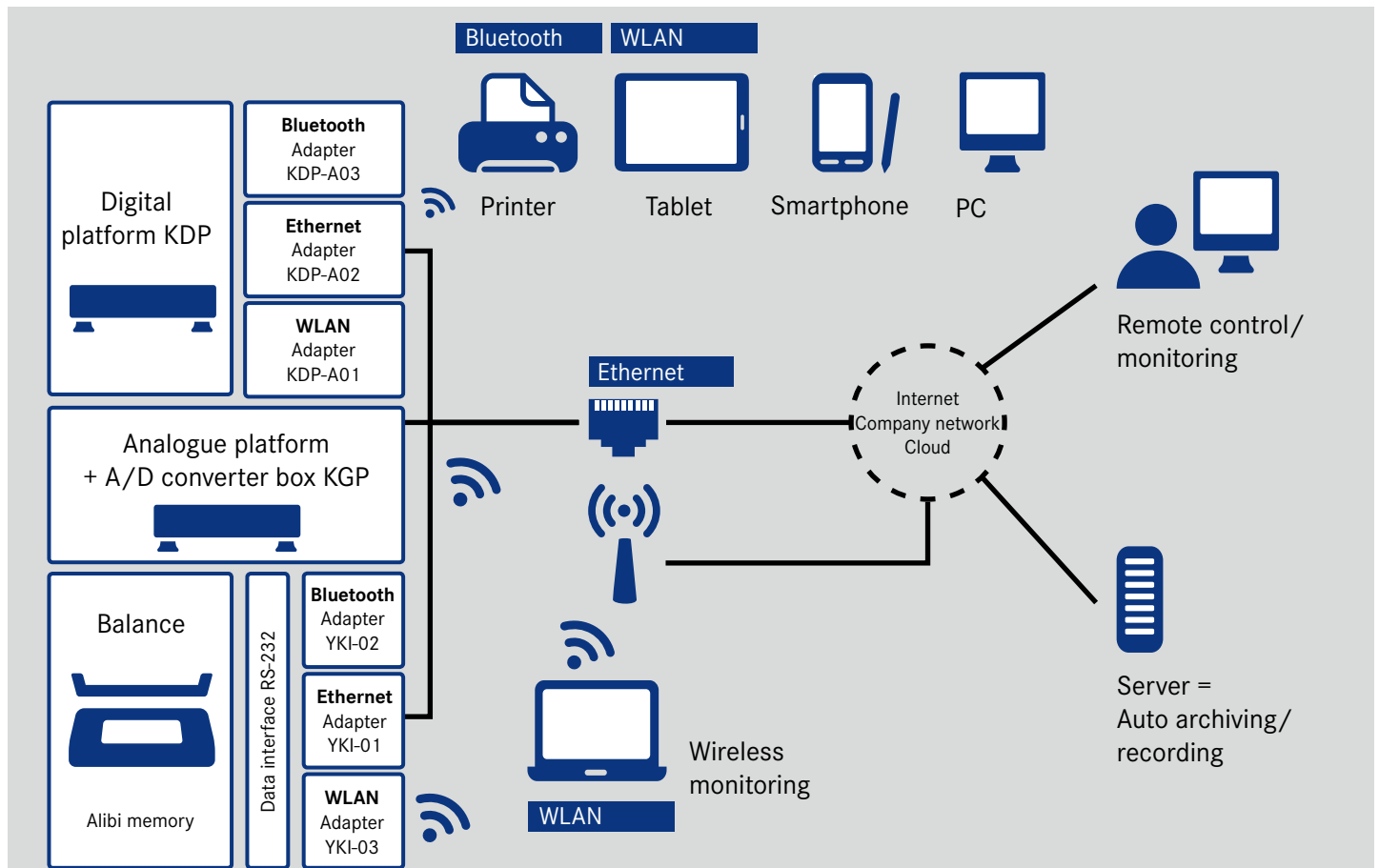

We will help to combine industrial production with the latest information and communication technology, with the aim of improving quality, reducing costs and using time and resources more efficiently so that you are able to react to future requirements in a more flexible manner. You will benefit from our uniform data protocol combined with our BalanceConnection 4.0 data software, for details please see page 13/14.



STANDARD

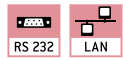

RS-232/Ethernet adapter KERN YKI-01

Adapter to connect balances, force measuring devices etc. with an RS-232 interface 2 to an IP-based Ethernet network 1. The adapter allows direct integration of measuring devices into most company networks, with automatic configuration using DHCP or statistical IP allocation. You can access the current measuring data at any time from within the whole network, without having to use additional cables. The adapter supports a wide range of configurational options using the enclosed administration software or by the web interface. The driver delivered with the goods allows you to access the measuring device with existing, non-network-compatible applications using a virtual COM port. Compatible with **KERN BalanceConnection software**. DIN track mount 3 or free-standing.

Scope of delivery: RS-232 Ethernet adapter with 1x Port RS-232 2, mains adapter 4, CD (driver, software, operating instructions), adhesive feet, (interface cable see page 163),

KERN YKI-01, € 290,-



STANDARD



RS-232/WLAN-Adapter KERN YKI-03

High-quality adapter for the wireless connection of balances, force measuring devices etc. with RS-232 interface to WLAN-enabled devices, such as tablets, laptops, Smartphones etc. In this way, where there is a physical separation or a large distance between the devices, the weighing data from one or several balances can be easily transferred without cable to a WLAN device or a network (relevant software on the WLAN device needed, not included in delivery). The adapter allows direct integration of measurement devices into most company networks, with automatic configuration using DHCP or statistical IP allocation. You can access the current measuring data at any time from within the whole network, without having to use additional cables. The adapter supports a wide range of configurational options using the enclosed administration software or by the web interface. The driver delivered with the goods allows you to access the measurement device with existing, non-network-compatible applications using a virtual COM port. Compatible with **KERN Software BalanceConnection**.

The adapter also has an Ethernet interface for a wired connection to an IP-based Ethernet network 1. Thanks to the screw terminals 2, the power connection can be implemented individually using individual wires or using the robust, screw-in power connector 3. Large input voltage range from 12 V–48 V. Suitable for wall mounting and DIN track mount 4 or free-standing.

Scope of delivery: RS-232/WLAN adapter, mains adapter, network cable (1 m), driver CD, (interface cable see page 163),

KERN YKI-03, € 690,-



Note: To connect to your network, you will need information from your network administrator. We recommend discussing connecting your device into your network with the administrator before you place your order.

Note: If you order a KERN balance at the same time, then the interface cable is **free of charge** (please specify balance model).

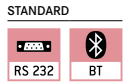

RS-232/Bluetooth-Adapter KERN YKI-02

Adapter for the wireless connection of balances, force measuring devices etc. with an RS-232 interface to Bluetooth devices, such as Bluetooth printers (e.g. KERN YKC-01), tablets, laptops, Smartphones etc. In this way, where there is a physical separation or a large distance between the devices, the weighing data from one or several balances can be easily sent without cable and printed on a Bluetooth printer or transferred to a Bluetooth device (you would need the relevant software on the Bluetooth device, not included with the delivery). The compact adapter with its attractive design can usually be connected directly to the balance **1**, e.g. an additional interface cable would not be necessary. Bluetooth adapter will be powered by the balance (if compatible) or with the mains adapter which is supplied as standard **2**. Range up to 100 m outside, depending on obstacles, such as, walls, the sensitivity and type of antenna of the receiver. Intersections of sending and receiving lines using the DCE/DTE switch **3**. Compatible with **KERN Software BalanceConnection**.

Scope of delivery: RS-232/Bluetooth adapter, mains adapter (EU/UK/USA/AUS/CH) **2**, USB-A to Mini-USB-B cable **4**, gender changer **5**, driver CD, (interface cable see page 163),

KERN YKI-02, € 220,-



Note: To connect to your network, you will need information from your network administrator. We recommend discussing connecting your device into your network with the administrator before you place your order.

Note: If you order a KERN balance at the same time, then the interface cable is **free of charge** (please specify balance model).



**Large display
KERN YKD-A02**

with superior display size, digit height 3" (76 mm). Luminescent, red LED display for easy reading of weight, even from a distance or under poor lighting conditions. 6 segments, mains connection as standard (230 V, EU/GB), connection using RS-232 data interface, dimensions WxDxH 541x55x180 mm.

Suitable for series IFB, BFB, NFB, UFA, UFB,

KERN YKD-A02, € 220,-



**Signal lamp
KERN CFS-A03**

Signal lamp for visual support of weighing with tolerance range. Three-colour LED, red, green, yellow. Power supply via balance using RS-232. Total dimensions WxDxH 100x180x300 mm

Suitable for series BFB, BFN, BID, CPB-N, GAB-N, GAB-P, IFB, IOC, KFB-TM, KFN-TM, KIB-TM, NBB, NFB, NFN, SFB, UFA, UFB, UFC, UFN,

KERN CFS-A03, € 250,-



**Power supply adapter set
KERN YKA-02**

from standard EU to GB/US/AUS/CH etc. Four pieces. Ideal for devices with Class II protection (not earthed). Ideal for Euro moulded plug,

KERN YKA-02, € 31,-



**2nd RS-232 data interface
KERN CFS-A04**

separate Y cable, e.g. for simultaneous connection of a printer, signal lamp etc.

Suitable for series BAN, BFB, CFS, CPB-N, GAB-N, GAB-P, IFB, KFB-TM, NFB, NFN, UFN, UFA, UFB, SFB,

KERN CFS-A04, € 35,-



**RS-232/USB adapter
KERN AFH 12**

to connect peripheral devices with USB connection, fits on all balances and measuring instruments with RS-232 port.

Scope of delivery: Converter cable, CD with driver,

KERN AFH 12, € 85,-



**2x RS-232/USB adapter
KERN AFH 14**

to connect peripheral devices with USB connection, fits on all balances and measuring instruments with RS-232 port.

Scope of delivery: Converter cable, CD with driver,

KERN AFH 14, € 115,-



**Stand (tripodal)
KERN YKP-01**

stable and robust, to elevate display device, stainless steel, height-adjustable, large three-legged adjustable foot, height of stand approx. 750–1000 mm, Factory Option.

Suitable for series BFA, BBB, BFN, BBN, KEN-TM, NFN, SFB (from weighing plate size WxD 500×400 mm), UFN,

KERN YKP-01, € 370,-



**Stand (tripodal)
KERN YKP-02**

stable and robust, to elevate display device, stainless steel, height-adjustable, large three-legged adjustable foot, height of stand approx. 750–1000 mm, Factory Option.

Suitable for series BFB, BXS, BFS, BFA, BBB, BBN, BKN, IFS, IFB, KFE-TM, KXG-TM, KXS-TM, KEN-TM, NFB, NBB, SFE, UFA, UFB, UFC,

KERN YKP-02, € 190,-



**Protective dust cover
KERN ABS-A08**

For protection from dust and light.

Suitable for all KERN analytical balances and precision balances with glass draught shield,

KERN ABS-A08, € 30,-



**Tare pan
KERN RFS-A02**

Made of stainless steel, which makes cleaning easy and hygienic. Ideal for weighing loose screws, small parts, fruit, vegetables, cheese, etc.

- WxD×H 370×240×20 mm
- Net weight approx. 524 g

KERN RFS-A02, € 55,-



**Tare pan with pan beam
KERN CH-A01N**

Made of stainless steel. Ideal for weighing loose small parts, fruit, vegetables etc. Max. load 30 kg. Removable tare pan which makes cleaning easy and hygienic.

- Suitable for models KERN CH 15K20, HCB 20K10, HCN 20K50IP, HDB-N, HDB-XL
- Dimensions: tare pan, Ø/H 160×40 mm (dim. outside), 240×40 mm (dim. inside)
 - Pan beam: WxD×H 290×240×300 mm 290×240×340 mm (incl. tare pan)
 - Total net weight approx. 500 g

KERN CH-A01A, € 70,-



**Universal density set
KERN YDB-03**

Universal density set for precise and convenient density determination of liquids and solids $\leq/\geq 1$. Suitable for all KERN analytical balances.

Scope of delivery: Beaker (Ø×H 84×113 mm), thermometer, sample holder, adapter, equalising weights, volume plummet (stainless steel, 20 g), universal submersible basket for solid bodies which float and sink. The wire of the submersible basket has a diameter of 0.5 mm and therefore complies with the requirements of DIN EN ISO 1183-1 (test methods for the determination of density of non-foamed plastics),

KERN YDB-03, € 390,-

Optional:
Density determination of the volume plummet, DAkkS calibration certificate with all data relating to the density and volume,

KERN 962-335V, € 143,-



STANDARD



Ioniser to neutralise electrostatic charge

KERN YBI-01A

Goods to be weighed which are non-conductive, such as plastic, china, glass, etc often carry electrostatic charge. The electromagnetic field which then occurs between the goods to be weighed and the balance can cause the weighing result to be distorted by up to a gramme.

Therefore, when weighing in milligrammes or even smaller increments, we recommend neutralising the electrostatic charge with the KERN AC-Korona discharge ioniser. With feet  supplied with the ioniser, it can be positioned conveniently next to the balance or you can manually direct it from all sides onto a particular item to be weighed.

- Discharge of ozone 0,05 ppm/h
- Total dimensions W×D×H
115×100×60 mm (Adjustable foot retracted),
115×110×80 mm (Adjustable foot folded out)
- Net weight approx. 0,31 kg
- Mains connection 100–240 V, 50/60 Hz,
AC power supply, DC 12 V, 500 mA, output,

KERN YBI-01A, € 940,-

Weighing table

KERN YPS-03

The KERN YPS-03 weighing table has been constructed to absorb vibrations and oscillations, which would otherwise distort the weighing result.

The YPS-03 weighing table consists of:

- a heavy, polished granite slab (34 kg) and is positioned on absorbing rubber components and is used as a surface on which to stand the analytical balance
- a work table, the work surface of which surrounds the slab and offers many storage options. The sturdy powder-coated steel frame has four height-adjustable feet, which can be used to accurately level the weighing table if the floor is at all uneven
- You can work in an ergonomic way at the weighing table whether you are in a standing or seated position. The inlet on the front of the table offers enough space for you to sit down and operate the scale without touching the weighing table.
- All surfaces are easy and hygienic to clean

- Suitable for all KERN analytical balances with total dimensions $\leq W \times D 270 \times 410$ mm
- Total dimensions W×D×H
768×648×800 mm (Height adjustable)
- Dimensions granite slab, W×D×H
270×410×115 mm
- Net weight approx. 62 kg

Ready for shipping in 2 working days. Dispatch complete on pallet. Please ask for dimensions, gross weight, shipping costs,

KERN YPS-03, € 990,-

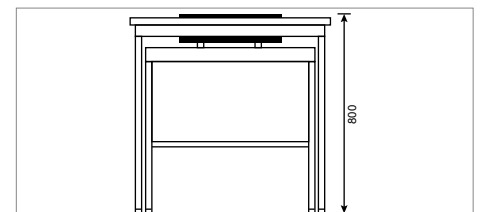
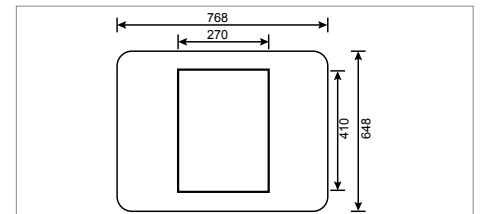



STANDARD



Roller conveyor KERN YRO-01/ YRO-02/ YRO-03

Through the **smooth-running KERN roller conveyor attachments**, KERN YRO, you can convert your platform scale into a **robust measuring system** for rapid and flexible weight determination in conveyor applications

Especially **suitable for use in production and dispatch lines**, where time means money. The goods or packages can either be weighed as they pass over the balance or, at fixed stations, heavy goods can easily be pushed onto the scale thanks to the roller conveyor and moved onto the connected roller conveyor

- **Simply connect the roller conveyor attachment to a platform (e.g. KERN IFB, IFS, IXS, KFP, KXP, SXS) – done!**
- **Robust aluminium profile frame.** The modular design means that you can **easily disassemble it for cleaning** or to replace individual components
- **Smooth-running, hot-dip galvanised steel rollers with ball bearings**
- **Conductive rollers**
- Suitable for use in **dry environments**
- Roller distance approx. 30 mm
- Direction of movement is lengthways

- Scope of delivery: 1 roller conveyor attachment (without scale)

Model	Total dimensions W×D×H	Suitable for platforms with weighing plate sizes W×D	Total net weight approx.	Price excl. of VAT ex works €
KERN	mm	mm	kg	
YRO-01	405×305×130	400×300	6	660,-
YRO-02	505×405×130	500×400	9	680,-
YRO-03	655×505×130	650×500	12	910,-



Test weights

Weights yesterday and today

Weights have always been used to carry out weighing procedures. This original purpose has almost disappeared. Today, weights are used almost exclusively for adjusting and testing = calibration of electronic balances. We therefore call them "Test weights" as this is their purpose of use.

Adjustment or calibration?

► **Adjusting** a balance means that you are intervening in the weighing system, to make sure that the display is set to show the correct nominal value. With ► **calibration** on the other hand, there is no intervention, you are testing whether the display is correct and documenting any deviation.

Testing, the right way!

The internationally valid OIML norm R111:2004 classifies test weights hierarchically in accuracy classes, where E1 is the most accurate and M3 is the least accurate weight class. With KERN you get the whole test weight range in all OIML accuracy classes E1, E2, F1, F2, M1, M2, M3.

As the appropriate test weight is only classed as checking equipment according to ► **ISO 9000ff** if it has the relevant proof of accuracy, all KERN test weights come with an appropriate ► **DAkkS-calibration certificate**. For further details, see the calibration service section on page 194.

KERN offers you the appropriate test weight package for your balance, consisting of the test weight, box and DAkkS-calibration certificate, as proof of its accuracy.







The best prerequisite for a correct adjustment or checking of your scales.

► **See the glossary on page 206–208**

Test weights: classes of accuracy E, F, M and their general relation to the types of balances:

- E1 Test weights for customers who require a high degree of accuracy for the most demanding applications. For high-resolution balances with $d > 1,000,000$. Use recommended with DAkkS calibration certificate only.
- E2 Most accurate test weights for high resolution analytical balances of verification class I $\geq 100,000$ e
- F1 Test weights for analytical balances/precision balances for verification class I/II $\leq 100,000$ e
- F2 Test weights for precision balances of verification class II $\leq 30,000$ e
- M1 Test weights for industrial and commercial scales of verification class III $\leq 10,000$ e

The appropriate test or adjustment weight for your new KERN balance can also be found directly in the accessories of the balance in our webshop

KERN DAkkS delivery times & shipping type	Total weight ≤ 30 kg (gross weight, incl. packaging)	Total weight > 30 kg (gross weight, incl. packaging)
DAkkS standard service Class E2 – M3	 4 DAYS	 4 DAYS
DAkkS standard service Class E1, 1 mg – 500 mg and recalibration 1 g – 10 kg with a known volume	 10 DAYS	 10 DAYS
Class E1, ≥ 1 g, incl. volume determination (new weights)	 15 DAYS	 15 DAYS
Special weights, Newton weights, heavy duty weights, weight carriers, wooden boxes for individual weight sets etc. (e.g. 334-14 1ff, 347-14 1ff, 346-8 1ff, 315-040-100ff, 335-040-200ff)	on request	



Sascha Skender

Product specialist Test weights

Tel. +49 7433 9933-158

Fax +49 7433 9933-29158

sascha.skender@kern-sohn.com

Just lean back – we have just the right test weight for your measuring device

KERN offers you a large range of OIML test weights, which you can use at any time to quickly and reliably check your balance, force-measuring device, etc.. From milligram weights to tonne weights, from the classic OIML design to special weights which are specifically manufactured to your specifications, we can offer you just the right test weight, and naturally the weights have the relevant DAkkS calibration certificate or factory calibration certificate.

On the following pages you will see a selection of standard test weights for OIML error limit classes E1, E2, F1, F2, M1, M2, M3.

We will be happy to manufacture special (large) weights, weight containers, Newton weights or weights with special weight values for you on request. Our test weights product specialist will be happy to give you expert, comprehensive advice.

All the security you need!

„KERN Safety Sets“ which have been specially developed and put together and contain the right test weights to test and monitor your balance. This “KERN Safety Set” contains one test weight for testing the upper end of the weighing range of your balance and one test weight for testing the lower end. As an option, the “KERN Safety Set”

has space for another test weight, for testing your balance at a weight which is relevant for you. Useful accessories which have been selected to suit that particular “KERN Safety Set”, such as, for example, special gloves, tweezers, weight grips, brushes, etc. will assist you in handling your test weights properly. Stored in the practical protective case

next to your balance, you can check and ensure the high precision of your balance at any time.

Just ask our test weight product specialist, he will be happy to recommend the right “KERN Safety Set” for your balance.











Marking – never lose track again!

With the large variety of test equipment used then it is essential that they are identified accurately. We can help you with this and can mark, etch or engrave your weights to your specifications. Whether it's letters, numbers, your logo, barcodes or something else - it's your choice. Our product specialist "Test weights" will gladly help you with any questions about this service, prices, etc.



Our KERN weight cases at a glance:

					
↓	↓	↓	↓	↓	↓
					
Plastic box for individual weights	Aluminium case for individual weights	Wooden box, lined for individual weights	Plastic case for weight sets	Aluminium case for weight sets	Wooden case, lined for weight sets

It's your choice!

To protect your test weights we can offer you an appropriate case. If there are no legal or normative specifications, then you have the choice between plastic, aluminium or wood. The available cases are shown as a symbol in the test weight tables on the following pages. In this way you have all the materials, versions, sizes and prices at a glance, listed in a concise way.

Selection of the appropriate test weight for your balance

A balance can never be more accurate than the test weight used to adjust it, it all depends on its tolerance. The accuracy of the test weight should correspond to the readout [d] of the balance, or rather be better. Nominal weight value is shown in adjust mode "CAL" in the balance display. Given a choice, the heaviest weight is the most suitable for accurate measurement.

Once accuracy and nominal weight value are specified, the suitable test weight is selected according to the tolerances "Tol" of the individual accuracy classes E2 - M3, see column "Tol ± mg" at the respective weight and table at page 173.

Example:

Balance with weighing range [Max] 2000 g = 2 kg
and readout [d] = 0,01 g = 10 mg

- The accuracy of the required test weight is determined by readout [d]: max. tolerance ± 10 mg.
- Displayed weight size on "CAL" mode: 1000 g or 2000 g. The required test weight has a 2 kg weight size.
- Suitable test weights with ± 10 mg tolerance and 2 kg weight size, can be found in accuracy class F1. KERN-No 326-12, see page 179.

Exception, analytical balances (readout [d] ≤ 0,1 mg):

E1 test weights are recommended. Depending on the safety requirements, E2 test weights with a DAkkS calibration certificate will also be sufficient.

From brass to stainless steel - the right test weight for every situation



Test weight →	Knob shape with lifting knob, polished stainless steel	Compact shape with carrying grip, polished stainless steel	Knob shape with lifting knob, polished stainless steel	ECO-shape, polished stainless steel	Knob shape with lifting knob, finely turned stainless steel	Knob shape with lifting knob, finely turned brass
Features ↓						
Conforms to OIML:R111	yes	yes	yes	yes	yes	yes
Available classes	E1, E2	E2	F1	F1	F2, M1	M1, M2, M3
Upper surface	polished	polished	polished	polished	finely turned	finely turned
Material	Stainless steel	Stainless steel	Stainless steel	Stainless steel	Stainless steel	Brass
Adjusting cavity	no	no	yes	yes, from 20 g, readjustment can only be carried out by KERN	yes, from 20 g	yes, from 20 g
Marking (Milligram weights, generally none)	no	E2: None F1: Nominal value, etched	Nominal value, etched	Nominal value, etched	F2: Class + nominal value, etched; M1: Class + nominal value, adopted	Class + nominal value, adopted
Verification possible	yes	yes	yes	no	yes	yes, M1 only
Checking equipment for verification purposes	approved	approved	approved	approved	approved	approved, M1 only
Ideal as checking equipment in QM systems (e.g. ISO 9000 ff)	yes	yes	yes	yes	yes	yes
Benefits	<ul style="list-style-type: none"> • High-quality test weight for analytical and precision balances • Highly-refined surface • Ideal shape of the top for good grip 	<ul style="list-style-type: none"> • Affordable test weight for analytical and precision balances • Highly refined surface 	<ul style="list-style-type: none"> • Ideal, high-quality test weight for precision balances • no visible adjustment chamber • high long-term stability • Ideal shape of the top for good grip 	<ul style="list-style-type: none"> • Affordable test weight for analytical and precision balances • Highly refined surface • Optimum shape of the top for good grip 	<ul style="list-style-type: none"> • Ideal test weight for commercial and industrial scales • Ideal shape of the top for good grip 	<ul style="list-style-type: none"> • Affordable test weight for commercial and industrial scales • Ideal shape of the top for good grip

Composition table, valid for all KERN weight sets from 1 mg

Individual weights per set →	1	2	2	5	10	20	20	50	100	200	200	500	1	2	2	5	10	20	20	50	100	200	200	500	1	2	2	5	10	
Weight set ↓	mg	mg	mg	mg	mg	mg	mg	mg	mg	mg	mg	mg	g	g	g	g	g	g	g	g	g	g	g	g	g	kg	kg	kg	kg	kg
1 mg-500 mg	Total weight												1,11 g																	
1 mg-50 g													111,11 g																	
1 mg-100 g													211,11 g																	
1 mg-200 g													611,11 g																	
1 mg-500 g													1.111,11 g																	
1 mg-1 kg													2.111,11 g																	
1 mg-2 kg													6.111,11 g																	
1 mg-5 kg													11.111,11 g																	
1 mg-10 kg													21.111,11 g																	

The key points from the OIML norm R111:2004

OIML (Organisation Internationale de Metrologie Legale) has established the exact metrological requirements for weights in verified applications in approx. 100 states all over the world. The OIML recommendation R111 (2004 Edition) for weights relates to sizes 1 mg – 5000 kg. Statements are made on the accuracy, materials, geometric shape, marking and storage of the weights.

Error limits for weights of classes E1 to M3

The error limit classes are in fixed hierarchical levels in the proportion of 1:3, where E1 is the most accurate and M3 is the least accurate weight class. When testing weights with other weights, the correct test class is the next highest class.

Error limit classes (= tolerances)

The values given in the table below (tolerances ± ... mg) are the respective permitted fabrication tolerances. They are to be equal to the ► **measuring uncertainty** of the weight, if no ► **DAkkS calibration certificate** is available.

Conventional mass

The problem is the air buoyancy, which makes the weight appear lighter. In order to avoid this “distortion” in daily use, all weights are adjusted to the unit specifications as given in R111, e.g. it is accepted that: material density of the weights is 8000 kg/m³, air density is 1.2 kg/m³ and measuring temperature is 20 °C.

KERN test weights: Unless otherwise specified, they conform to OIML R111:2004 in every detail.

► *See the glossary, page 204–206*

Nominal value ↓	OIML R111:2004 Maximum permissible errors for weights = permissible tolerances “Tol ± mg”						
	E1	E2	F1	F2	M1	M2	M3
1 mg	± 0,003 mg	± 0,006 mg	± 0,020 mg	± 0,06 mg	± 0,20 mg	-	-
2 mg	± 0,003 mg	± 0,006 mg	± 0,020 mg	± 0,06 mg	± 0,20 mg	-	-
5 mg	± 0,003 mg	± 0,006 mg	± 0,020 mg	± 0,06 mg	± 0,20 mg	-	-
10 mg	± 0,003 mg	± 0,008 mg	± 0,025 mg	± 0,08 mg	± 0,25 mg	-	-
20 mg	± 0,003 mg	± 0,010 mg	± 0,03 mg	± 0,10 mg	± 0,3 mg	-	-
50 mg	± 0,004 mg	± 0,012 mg	± 0,04 mg	± 0,12 mg	± 0,4 mg	-	-
100 mg	± 0,005 mg	± 0,016 mg	± 0,05 mg	± 0,16 mg	± 0,5 mg	± 1,6 mg	-
200 mg	± 0,006 mg	± 0,020 mg	± 0,06 mg	± 0,20 mg	± 0,6 mg	± 2,0 mg	-
500 mg	± 0,008 mg	± 0,025 mg	± 0,08 mg	± 0,25 mg	± 0,8 mg	± 2,5 mg	-
1 g	± 0,010 mg	± 0,03 mg	± 0,10 mg	± 0,3 mg	± 1,0 mg	± 3,0 mg	± 10 mg
2 g	± 0,012 mg	± 0,04 mg	± 0,12 mg	± 0,4 mg	± 1,2 mg	± 4,0 mg	± 12 mg
5 g	± 0,016 mg	± 0,05 mg	± 0,16 mg	± 0,5 mg	± 1,6 mg	± 5,0 mg	± 16 mg
10 g	± 0,020 mg	± 0,06 mg	± 0,20 mg	± 0,6 mg	± 2,0 mg	± 6,0 mg	± 20 mg
20 g	± 0,025 mg	± 0,08 mg	± 0,25 mg	± 0,8 mg	± 2,5 mg	± 8,0 mg	± 25 mg
50 g	± 0,03 mg	± 0,10 mg	± 0,3 mg	± 1,0 mg	± 3,0 mg	± 10 mg	± 30 mg
100 g	± 0,05 mg	± 0,16 mg	± 0,5 mg	± 1,6 mg	± 5,0 mg	± 16 mg	± 50 mg
200 g	± 0,10 mg	± 0,3 mg	± 1,0 mg	± 3,0 mg	± 10 mg	± 30 mg	± 100 mg
500 g	± 0,25 mg	± 0,8 mg	± 2,5 mg	± 8,0 mg	± 25 mg	± 80 mg	± 250 mg
1 kg	± 0,5 mg	± 1,6 mg	± 5,0 mg	± 16 mg	± 50 mg	± 160 mg	± 500 mg
2 kg	± 1,0 mg	± 3,0 mg	± 10 mg	± 30 mg	± 100 mg	± 300 mg	± 1 000 mg
5 kg	± 2,5 mg	± 8,0 mg	± 25 mg	± 80 mg	± 250 mg	± 800 mg	± 2 500 mg
10 kg	± 5,0 mg	± 16 mg	± 50 mg	± 160 mg	± 500 mg	± 1 600 mg	± 5 000 mg
20 kg	± 10 mg	± 30 mg	± 100 mg	± 300 mg	± 1 000 mg	± 3 000 mg	± 10 g
50 kg	± 25 mg	± 80 mg	± 250 mg	± 800 mg	± 2 500 mg	± 8 000 mg	± 25 g
100 kg	-	± 160 mg	± 500 mg	± 1 600 mg	± 5 000 mg	± 16 g	± 50 g
200 kg	-	± 300 mg	± 1 000 mg	± 3 000 mg	± 10 g	± 30 g	± 100 g
500 kg	-	± 800 mg	± 2 500 mg	± 8 000 mg	± 25 g	± 80 g	± 250 g
1 000 kg	-	± 1 600 mg	± 5 000 mg	± 16 g	± 50 g	± 160 g	± 500 g
2 000 kg	-	-	± 10 g	± 30 g	± 100 g	± 300 g	± 1 000 g
5 000 kg	-	-	± 25 g	± 80 g	± 250 g	± 800 g	± 2 500 g



PREMIUM⁺ WEIGHTS

Note: Our highly-accurate OIML test weights are also available **PREMIUM⁺ weights** for that extra level of safety. Thanks to the most modern manufacturing technology, these test weights can also be adjusted within the specified error limit classes (= tolerances).

I.e. this means that these **PREMIUM⁺ weights** have a significantly longer service life, thanks this guaranteed positive tolerance. This is of particular benefit with intensive use of the test weights.

For all the details on this **PREMIUM⁺ service** please see www.kern-lab.com/premium+ or look at the weight you want in our online shop at www.kern-sohn.com

Test weights and cases

Class E1



Milligram weights, wire shape



Wooden box, for milligram weights



Individual weights, knob shape



Wooden box, lined,
for individual weights



Wooden box, lined,
for individual weights



Weight set, knob shape





Aluminium case, lined, for weight sets,
knob shape



Wooden case, lined, for weight sets,
knob shape



Class E1 · Milligram weights, wire shape, stainless steel

Weight	Tol +/- mg	Wire shape		Aluminium Box		Wooden box		DAkkS certificate	
		KERN	€	KERN		€	KERN		€
1 mg	0,003	308-31	58,-	317-090-600	14,-	338-090-200	16,-	962-251	52,-
2 mg	0,003	308-32	58,-	317-090-600	14,-	338-090-200	16,-	962-252	52,-
5 mg	0,003	308-33	58,-	317-090-600	14,-	338-090-200	16,-	962-253	52,-
10 mg	0,003	308-34	58,-	317-090-600	14,-	338-090-200	16,-	962-254	52,-
20 mg	0,003	308-35	58,-	317-090-600	14,-	338-090-200	16,-	962-255	52,-
50 mg	0,004	308-36	58,-	317-090-600	14,-	338-090-200	16,-	962-256	52,-
100 mg	0,005	308-37	58,-	317-090-600	14,-	338-090-200	16,-	962-257	52,-
200 mg	0,006	308-38	58,-	317-090-600	14,-	338-090-200	16,-	962-258	52,-
500 mg	0,008	308-39	58,-	317-090-600	14,-	338-090-200	16,-	962-259	52,-



Class E1 · Individual weights, knob shape, polished stainless steel

Weight	Tol +/- mg	Individual weights, knob shape		Wooden box		DAkkS certificate Initial calibration*		DAkkS certificate Recalibration	
		KERN	€	KERN		€	KERN	€	KERN
1 g	0,010	307-01	83,-	317-010-100	26,-	963-231	193,-	962-231 R	52,-
2 g	0,012	307-02	89,-	317-020-100	26,-	963-232	193,-	962-232 R	52,-
5 g	0,016	307-03	96,-	317-030-100	26,-	963-233	193,-	962-233 R	52,-
10 g	0,020	307-04	104,-	317-040-100	26,-	963-234	193,-	962-234 R	52,-
20 g	0,025	307-05	113,-	317-050-100	26,-	963-235	193,-	962-235 R	52,-
50 g	0,030	307-06	135,-	317-060-100	27,-	963-236	193,-	962-236 R	52,-
100 g	0,050	307-07	162,-	317-070-100	28,-	963-237	193,-	962-237 R	52,-
200 g	0,100	307-08	194,-	317-080-100	28,-	963-238	193,-	962-238 R	52,-
500 g	0,250	307-09	280,-	317-090-100	29,-	963-239	193,-	962-239 R	52,-
1 kg	0,500	307-11	425,-	317-110-100	35,-	963-241	193,-	962-241 R	52,-
2 kg	1,000	307-12	630,-	317-120-100	44,-	963-242	465,-	962-242 R	64,-
5 kg	2,500	307-13	1060,-	317-130-100	66,-	963-243	465,-	962-243 R	64,-
10 kg	5,000	307-14	1530,-	317-140-100	89,-	963-244	465,-	962-244 R	64,-
20 kg	10,000	307-15	3900,-	317-150-100	340,-	963-245	1160,-	962-245 R	590,-
50 kg	25,000	307-16	7900,-	317-160-100	415,-	963-246	1360,-	962-246 R	660,-

* For E1 weights > 1g at the point of initial calibration, a volume determination will be carried out in accordance with OIML:R111. When recalibrating, this is not required.

Class E1 · Weight sets, knob shape, polished stainless steel

Milligram weight sets 1 mg - 500 mg are supplied in a separate plastic case

Weight set	Aluminium case, knob shape		Wooden case, knob shape		DAkkS certificate Initial calibration*		DAkkS certificate Recalibration	
	KERN 	€	KERN 	€	KERN	€	KERN	€
1 mg - 500 mg	308-426	810,-	308-42	780,-	962-250	350,-	962-250 R	350,-
1 mg - 50 g	303-026	1530,-	303-02	1540,-	963-201	1070,-	962-201 R	560,-
1 mg - 100 g	303-036	1690,-	303-03	1700,-	963-202	1170,-	962-202 R	580,-
1 mg - 200 g	303-046	2080,-	303-04	2090,-	963-203	1350,-	962-203 R	630,-
1 mg - 500 g	303-056	2410,-	303-05	2420,-	963-204	1440,-	962-204 R	660,-
1 mg - 1 kg	303-066	2830,-	303-06	2840,-	963-205	1530,-	962-205 R	700,-
1 mg - 2 kg	303-076	4140,-	303-07	4150,-	963-206	2000,-	962-206 R	750,-
1 mg - 5 kg	303-086	5290,-	303-08	5300,-	963-207	2450,-	962-207 R	770,-
1 mg - 10 kg	303-096	6880,-	303-09	6890,-	963-208	2900,-	962-208 R	800,-
1 g - 50 g	304-026	900,-	304-02	910,-	963-215	770,-	962-215 R	245,-
1 g - 100 g	304-036	1060,-	304-03	1070,-	963-216	860,-	962-216 R	270,-
1 g - 200 g	304-046	1450,-	304-04	1460,-	963-217	1040,-	962-217 R	320,-
1 g - 500 g	304-056	1780,-	304-05	1790,-	963-218	1130,-	962-218 R	350,-
1 g - 1 kg	304-066	2200,-	304-06	2210,-	963-219	1230,-	962-219 R	375,-
1 g - 2 kg	304-076	3510,-	304-07	3520,-	963-220	1780,-	962-220 R	425,-
1 g - 5 kg	304-086	4660,-	304-08	4670,-	963-221	2230,-	962-221 R	450,-
1 g - 10 kg	304-096	6250,-	304-09	6260,-	963-222	2690,-	962-222 R	485,-

Test weights and cases

Class E2

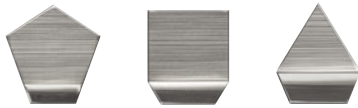

Milligram weights, flat polygonal sheet



Individual weights, compact shape



Individual weights, knob shape



Plastic box, lined, for individual weights ≤ 50 g



Plastic box, lined, for individual weights ≥ 100 g



Aluminium box, lined, for individual weights



Wooden box, lined, for individual weights ≤ 500 g



Wooden box, lined, for individual weights ≥ 1 kg



Plastic case, lined for weight sets, compact shape



Plastic case, lined, for weight sets, knob shape





Aluminium case, lined, for weight sets, compact shape / knob shape





Wooden case, lined, for weight sets, compact shape / knob shape

Class E2 · Milligram weights, flat polygonal sheet

Test weight material: Aluminium 1 mg – 5 mg/German silver 10 mg – 500 mg





Weight	Tol +/- mg	Flat polygonal sheet		Plastic box		Aluminium box		Wooden box		DAkkS certificate	
		KERN	€	KERN 	€	KERN 	€	KERN 	€	KERN	€
1 mg	0,006	318-01	23,-	347-009-400	2,-	317-009-600	14,-	338-090-200	16,-	962-351	26,-
2 mg	0,006	318-02	23,-	347-009-400	2,-	317-009-600	14,-	338-090-200	16,-	962-352	26,-
5 mg	0,006	318-03	23,-	347-009-400	2,-	317-009-600	14,-	338-090-200	16,-	962-353	26,-
10 mg	0,008	318-04	23,-	347-009-400	2,-	317-009-600	14,-	338-090-200	16,-	962-354	26,-
20 mg	0,010	318-05	23,-	347-009-400	2,-	317-009-600	14,-	338-090-200	16,-	962-355	26,-
50 mg	0,012	318-06	23,-	347-009-400	2,-	317-009-600	14,-	338-090-200	16,-	962-356	26,-
100 mg	0,016	318-07	23,-	347-009-400	2,-	317-009-600	14,-	338-090-200	16,-	962-357	26,-
200 mg	0,020	318-08	23,-	347-009-400	2,-	317-009-600	14,-	338-090-200	16,-	962-358	26,-
500 mg	0,025	318-09	23,-	347-009-400	2,-	317-009-600	14,-	338-090-200	16,-	962-359	26,-

Class E2 · Individual weights, compact shape or knob shape, polished stainless steel

Weight	Tol +/- mg	Individual weights, compact shape		Individual weights, knob shape		Plastic box		Aluminium box		Wooden box		DAkkS certificate	
		KERN	€	KERN	€	KERN 	€	KERN 	€	KERN 	€	KERN	€
1 g	0,03	316-01	31,-	317-01	45,-	317-020-400	4,50	317-010-600	14,-	317-010-100	26,-	962-331	26,-
2 g	0,04	316-02	33,-	317-02	48,-	317-020-400	4,50	317-020-600	14,-	317-020-100	26,-	962-332	26,-
5 g	0,05	316-03	35,-	317-03	51,-	317-030-400	4,50	317-030-600	14,-	317-030-100	26,-	962-333	26,-
10 g	0,06	316-04	37,-	317-04	54,-	317-040-400	4,50	317-040-600	14,-	317-040-100	26,-	962-334	26,-
20 g	0,08	316-05	42,-	317-05	62,-	317-050-400	4,50	317-050-600	14,-	317-050-100	26,-	962-335	26,-
50 g	0,10	316-06	45,-	317-06	73,-	317-060-400	5,-	317-060-600	14,-	317-060-100	27,-	962-336	26,-
100 g	0,16	316-07	49,-	317-07	80,-	317-070-400	5,-	317-070-600	14,-	317-070-100	28,-	962-337	33,-
200 g	0,30	316-08	62,-	317-08	101,-	317-080-400	6,-	317-080-600	14,-	317-080-100	28,-	962-338	33,-
500 g	0,80	316-09	103,-	317-09	168,-	317-090-400	7,-	317-090-600	14,-	317-090-100	29,-	962-339	33,-
1 kg	1,60	316-11	149,-	317-11	245,-	317-110-400	8,-	317-110-600	24,-	317-110-100	35,-	962-341	33,-
2 kg	3,00	316-12	245,-	317-12	380,-	317-120-400	12,-	317-120-600	27,-	317-120-100	44,-	962-342	41,-
5 kg	8,00	316-13	360,-	317-13	550,-	317-130-400	16,-	317-130-600	47,-	317-130-100	66,-	962-343	41,-
10 kg	16,00	316-14	530,-	317-14	800,-	317-140-400	20,-	317-140-600	65,-	317-140-100	89,-	962-344	41,-
20 kg	30,00	-	-	317-15	1680,-	-	-	317-150-600	205,-	317-150-100	340,-	962-345	52,-
50 kg	80,00	-	-	317-16	3500,-	-	-	317-160-600	250,-	317-160-100	415,-	962-346	64,-

Class E2 · Weight sets, compact shape or knob shape, polished stainless steel

Test weight material: Polished stainless steel/German Silver, Individual weights: polished stainless steel.
Milligram weight sets 1 mg - 500 mg are supplied in a separate plastic case

Weight sets	Compact shape in plastic case		Knob shape in plastic case		Knob shape in aluminium case		Knob shape in wooden case		DAkkS certificate	
	KERN 	€	KERN 	€	KERN 	€	KERN 	€	KERN	€
1 mg - 500 mg	318-22	320,-	318-22	320,-	318-226	330,-	318-22	320,-	962-350	190,-
1 mg - 50 g	-	-	313-024	790,-	313-026	830,-	313-02	840,-	962-301	315,-
1 mg - 100 g	-	-	313-034	880,-	313-036	900,-	313-03	910,-	962-302	340,-
1 mg - 200 g	-	-	313-044	1070,-	313-046	1110,-	313-04	1120,-	962-303	385,-
1 mg - 500 g	-	-	313-054	1230,-	313-056	1330,-	313-05	1340,-	962-304	410,-
1 mg - 1 kg	-	-	313-064	1560,-	313-066	1590,-	313-06	1600,-	962-305	435,-
1 mg - 2 kg	-	-	313-074	2330,-	313-076	2400,-	313-07	2410,-	962-306	495,-
1 mg - 5 kg	-	-	313-084	2880,-	313-086	3050,-	313-08	3060,-	962-307	530,-
1 mg - 10 kg	-	-	-	-	313-096	3940,-	313-09	3950,-	962-308	560,-
1 g - 50 g	312-024	340,-	314-024	520,-	314-026	550,-	314-02	560,-	962-315	127,-
1 g - 100 g	312-034	380,-	314-034	590,-	314-036	630,-	314-03	640,-	962-316	150,-
1 g - 200 g	312-044	480,-	314-044	790,-	314-046	830,-	314-04	840,-	962-317	196,-
1 g - 500 g	312-054	570,-	314-054	970,-	314-056	1050,-	314-05	1060,-	962-318	220,-
1 g - 1 kg	312-064	750,-	314-064	1280,-	314-066	1300,-	314-06	1310,-	962-319	245,-
1 g - 2 kg	312-074	1160,-	317-074	2050,-	314-076	2120,-	314-07	2130,-	962-320	305,-
1 g - 5 kg	312-084	1490,-	317-084	2600,-	314-086	2770,-	314-08	2780,-	962-321	340,-
1 g - 10 kg	-	-	-	-	314-096	3660,-	314-09	3670,-	962-322	370,-

Note Our highly-accurate OIML test weights are also available as **Premium+** weights for that extra level of safety, see all details page 173 or on www.kern-lab.com/premium+

Test weights and cases

Class F1

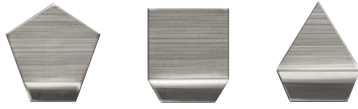

Milligram weights, flat polyagonal sheet



Individual weights / Weight sets, ECO shape



Individual weights / Weight sets, knob shape



Plastic box, lined, for individual weights ≤ 200 g

Plastic box, lined, for individual weights ≥ 500 g



Aluminium box, lined, for individual weights



Wooden box, lined, for individual weights ≤ 500 g



Wooden box, lined, for individual weights ≥ 1 kg



Plastic case, lined, for weight sets, ECO shape



Plastic case, lined for weight sets, knob shape



Aluminium case, lined, for weight sets ECO shape / knob shape



Wooden case, lined, for weight sets ECO shape / knob shape

Class F1 · Milligram weights, flat polygonal sheet

Test weight material Aluminium 1 mg – 5 mg/German silver 10 mg – 500 mg

Weight	Tol +/- mg	Flat polygonal sheet		Plastic box		Aluminium Box		Wooden Box		DAkkS certificate	
		KERN	€	KERN	€	KERN	€	KERN	€	KERN	€
1 mg	0,006	328-01	11,-	347-009-400	2,-	317-009-600	14,-	338-090-200	16,-	962-451	18,-
2 mg	0,006	328-02	11,-	347-009-400	2,-	317-009-600	14,-	338-090-200	16,-	962-452	18,-
5 mg	0,006	328-03	11,-	347-009-400	2,-	317-009-600	14,-	338-090-200	16,-	962-453	18,-
10 mg	0,008	328-04	11,-	347-009-400	2,-	317-009-600	14,-	338-090-200	16,-	962-454	18,-
20 mg	0,010	328-05	11,-	347-009-400	2,-	317-009-600	14,-	338-090-200	16,-	962-455	18,-
50 mg	0,012	328-06	11,-	347-009-400	2,-	317-009-600	14,-	338-090-200	16,-	962-456	18,-
100 mg	0,016	328-07	11,-	347-009-400	2,-	317-009-600	14,-	338-090-200	16,-	962-457	18,-
200 mg	0,020	328-08	11,-	347-009-400	2,-	317-009-600	14,-	338-090-200	16,-	962-458	18,-
500 mg	0,025	328-09	11,-	347-009-400	2,-	317-009-600	14,-	338-090-200	16,-	962-259	18,-

Class F1 · Individual weights, ECO shape or knob shape, polished stainless steel

Weight	Tol +/- mg	ECO shape		Knob shape		Plastic box		Aluminium Box		Wooden Box		DAkkS certificate	
		KERN	€	KERN	€	KERN	€	KERN	€	KERN	€	KERN	€
1 g	0,10	326-01	22,-	327-01	29,-	347-030-400	2,-	317-010-600	14,-	317-010-100	26,-	962-431	18,-
2 g	0,12	326-02	23,-	327-02	29,-	347-030-400	2,-	317-020-600	14,-	317-020-100	26,-	962-432	18,-
5 g	0,16	326-03	25,-	327-03	31,-	347-030-400	2,-	317-030-600	14,-	317-030-100	26,-	962-433	18,-
10 g	0,20	326-04	28,-	327-04	35,-	347-050-400	2,-	317-040-600	14,-	317-040-100	26,-	962-434	18,-
20 g	0,25	326-05	29,-	327-05	39,-	347-050-400	2,-	317-050-600	14,-	317-050-100	26,-	962-435	18,-
50 g	0,30	326-06	32,-	327-06	42,-	347-070-400	2,-	317-060-600	14,-	317-060-100	27,-	962-436	18,-
100 g	0,50	326-07	36,-	327-07	52,-	347-070-400	2,-	317-070-600	14,-	317-070-100	28,-	962-437	20,-
200 g	1,00	326-08	49,-	327-08	68,-	347-080-400	2,-	317-080-600	14,-	317-080-100	28,-	962-438	20,-
500 g	2,50	326-09	79,-	327-09	111,-	347-090-400	3,-	317-090-600	14,-	317-090-100	29,-	962-439	20,-
1 kg	5,00	326-11	104,-	327-11	154,-	347-110-400	3,-	317-110-600	24,-	317-110-100	35,-	962-441	20,-
2 kg	10	326-12	179,-	327-12	240,-	347-120-400	3,-	317-120-600	27,-	317-120-100	44,-	962-442	25,-
5 kg	25	326-13	260,-	327-13	355,-	347-130-400	9,-	317-130-600	47,-	317-130-100	66,-	962-443	25,-
10 kg	50	326-14	485,-	327-14	650,-	347-140-400	9,-	317-140-600	65,-	317-140-100	89,-	962-444	25,-
20 kg	100	-	-	327-15	1350,-	317-150-100	340,-	317-150-600	205,-	317-150-100	340,-	962-445	28,-
50 kg	250	-	-	327-16	2900,-	317-160-100	415,-	317-160-600	250,-	317-160-100	415,-	962-446	39,-

Class F1 · Weight sets, ECO shape, polished stainless steel

Test weight material: Milligram weights Aluminium/German Silver, individual weights polished stainless steel.
Milligram weight sets 1 mg - 500 mg are supplied in a separate plastic case

Weight sets	ECO shape in plastic case		ECO shape in aluminium case		ECO shape in wooden case		DAkkS certificate	
	KERN	€	KERN	€	KERN	€	KERN	€
1 mg - 500 mg	328-22	175,-	318-22	320,-	318-22	320,-	962-450	100,-
1 mg - 50 g	325-024	395,-	325-026	445,-	325-022	450,-	962-401	167,-
1 mg - 100 g	325-034	430,-	325-036	475,-	325-032	480,-	962-402	178,-
1 mg - 200 g	325-044	520,-	325-046	560,-	325-042	570,-	962-403	199,-
1 mg - 500 g	325-054	580,-	325-056	680,-	325-052	690,-	962-404	210,-
1 mg - 1 kg	325-064	760,-	325-066	770,-	325-062	780,-	962-405	220,-
1 mg - 2 kg	325-074	1010,-	325-076	1100,-	325-072	1110,-	962-406	250,-
1 mg - 5 kg	325-084	1250,-	325-086	1450,-	325-082	1460,-	962-407	265,-
1 mg - 10 kg	-	-	325-096	1970,-	325-092	1980,-	962-408	285,-
1 g - 50 g	326-024	235,-	326-026	280,-	326-022	290,-	962-415	67,-
1 g - 100 g	326-034	270,-	326-036	320,-	326-032	330,-	962-416	77,-
1 g - 200 g	326-044	355,-	326-046	420,-	326-042	425,-	962-417	98,-
1 g - 500 g	326-054	420,-	326-056	540,-	326-052	550,-	962-418	109,-
1 g - 1 kg	326-064	600,-	326-066	650,-	326-062	660,-	962-419	119,-
1 g - 2 kg	326-074	850,-	326-076	1010,-	326-072	1020,-	962-420	151,-
1 g - 5 kg	326-084	1090,-	326-086	1390,-	326-082	1400,-	962-421	166,-
1 g - 10 kg	-	-	326-096	1830,-	326-092	1840,-	962-422	182,-

Note Our highly-accurate OIML test weights are also available as **Premium+ weights** for that extra level of safety, see all details page 173 or on www.kern-lab.com/premium+

Class F1 · Weight sets, knob shape, polished stainless steel

Test weight material: Polished stainless steel/German Silver, Individual weights: polished stainless steel.

Milligram weight sets 1 mg - 500 mg are supplied in a separate plastic case

Weight sets	Knob shape in plastic case		Knob shape in aluminium case		Knob shape in wooden case		DAkkS certificate	
	KERN	€	KERN	€	KERN	€	KERN	€
1 mg - 500 mg	328-22	175,-	328-226	195,-	328-22	175,-	962-450	100,-
1 mg - 50 g	323-024	480,-	323-026	510,-	323-02	520,-	962-401	167,-
1 mg - 100 g	323-034	530,-	323-036	560,-	323-03	570,-	962-402	178,-
1 mg - 200 g	323-044	670,-	323-046	700,-	323-04	710,-	962-403	199,-
1 mg - 500 g	323-054	780,-	323-056	870,-	323-05	880,-	962-404	210,-
1 mg - 1 kg	323-064	1010,-	323-066	1030,-	323-06	1040,-	962-405	220,-
1 mg - 2 kg	323-074	1490,-	323-076	1560,-	323-07	1570,-	962-406	250,-
1 mg - 5 kg	323-084	1830,-	323-086	2000,-	323-08	2010,-	962-407	265,-
1 mg - 10 kg	-	-	323-096	2740,-	323-09	2750,-	962-408	285,-
1 g - 50 g	324-024	330,-	324-026	375,-	324-02	380,-	962-415	67,-
1 g - 100 g	324-034	385,-	324-036	430,-	324-03	435,-	962-416	77,-
1 g - 200 g	324-044	520,-	324-046	560,-	324-04	570,-	962-417	98,-
1 g - 500 g	324-054	630,-	324-056	710,-	324-05	720,-	962-418	109,-
1 g - 1 kg	324-064	850,-	324-066	880,-	324-06	890,-	962-419	119,-
1 g - 2 kg	324-074	1340,-	324-076	1400,-	324-07	1410,-	962-420	151,-
1 g - 5 kg	324-084	1680,-	324-086	1860,-	324-08	1870,-	962-421	166,-
1 g - 10 kg	-	-	324-096	2590,-	324-09	2600,-	962-422	182,-

Note

Our highly-accurate OIML test weights are also available as **Premium+** weights for that extra level of safety, see all details page 173 or on www.kern-lab.com/premium+

Test weights and cases

Class F2



Milligram weights, flat polygonal sheet

Individual weights / Weight sets, knob shape



Plastic box, lined, for individual weights ≤ 200 g

Plastic box, lined, for individual weights ≥ 500 g

Aluminium box, lined, for individual weights

Wooden box, for individual weights ≤ 500 g

Wooden box, lined, for individual weights ≥ 1 kg



Plastic case, lined, for weight sets knob shape



Aluminium case, lined, for weight sets knob shape

Wooden case, for weight sets knob shape



Test weights class F2

Class F2 · Milligram weights, flat polygonal sheet

Test weight material: Aluminium 1 mg – 5 mg/German Silver 10 mg – 500 mg

Weight	Tol +/- mg	Flat polygonal sheet		Plastic box		Aluminium Box		Wooden Box		DAkkS certificate	
		KERN	€	KERN 	€	KERN 	€	KERN 	€	KERN	€
1 mg	0,06	338-01	9,-	347-009-400	2,-	317-009-600	14,-	338-090-200	16,-	962-451	18,-
2 mg	0,06	338-02	9,-	347-009-400	2,-	317-009-600	14,-	338-090-200	16,-	962-452	18,-
5 mg	0,06	338-03	9,-	347-009-400	2,-	317-009-600	14,-	338-090-200	16,-	962-453	18,-
10 mg	0,08	338-04	9,-	347-009-400	2,-	317-009-600	14,-	338-090-200	16,-	962-454	18,-
20 mg	0,10	338-05	9,-	347-009-400	2,-	317-009-600	14,-	338-090-200	16,-	962-455	18,-
50 mg	0,12	338-06	9,-	347-009-400	2,-	317-009-600	14,-	338-090-200	16,-	962-456	18,-
100 mg	0,16	338-07	9,-	347-009-400	2,-	317-009-600	14,-	338-090-200	16,-	962-457	18,-
200 mg	0,20	338-08	9,-	347-009-400	2,-	317-009-600	14,-	338-090-200	16,-	962-458	18,-
500 mg	0,25	338-09	10,-	347-009-400	2,-	317-009-600	14,-	338-090-200	16,-	962-259	18,-



Class F2 · Individual weights, knob shape, finely turned stainless steel

Weight	Tol +/- mg	Knob shape		Plastic box		Aluminium Box		Wooden Box		DAkkS certificate	
		KERN	€	KERN 	€	KERN 	€	KERN 	€	KERN	€
1 g	0,10	337-01	18,-	347-030-400	2,-	317-010-600	14,-	337-010-200	14,-	962-431	18,-
2 g	0,12	337-02	19,-	347-030-400	2,-	317-020-600	14,-	337-020-200	14,-	962-432	18,-
5 g	0,16	337-03	20,-	347-030-400	2,-	317-030-600	14,-	337-030-200	14,-	962-433	18,-
10 g	0,20	337-04	20,-	347-050-400	2,-	317-040-600	14,-	337-040-200	14,-	962-434	18,-
20 g	0,25	337-05	25,-	347-050-400	2,-	317-050-600	14,-	337-050-200	14,-	962-435	18,-
50 g	0,30	337-06	27,-	347-070-400	2,-	317-060-600	14,-	337-060-200	15,-	962-436	18,-
100 g	0,50	337-07	30,-	347-070-400	2,-	317-070-600	14,-	337-070-200	15,-	962-437	20,-
200 g	1,00	337-08	40,-	347-080-400	2,-	317-080-600	14,-	337-080-200	16,-	962-438	20,-
500 g	2,50	337-09	57,-	347-090-400	3,-	317-090-600	14,-	337-090-200	19,-	962-439	20,-
1 kg	5	337-11	80,-	347-110-400	3,-	317-110-600	24,-	337-110-200	24,-	962-441	20,-
2 kg	10	337-12	120,-	347-120-400	3,-	317-120-600	27,-	337-120-200	27,-	962-442	25,-
5 kg	25	337-13	205,-	347-130-400	9,-	317-130-600	47,-	337-130-200	47,-	962-443	25,-
10 kg	50	337-14	395,-	347-140-400	9,-	317-140-600	65,-	337-140-200	60,-	962-444	25,-
20 kg	100	337-15	690,-	-	-	317-150-600	205,-	337-150-200	220,-	962-445	28,-
50 kg	250	337-16	1240,-	-	-	317-160-600	250,-	337-160-200	345,-	962-446	39,-

Class F2 · Weight sets, knob shape, finely turned stainless steel

Test weight material: Milligram weights Aluminium/German Silver, individual weights polished stainless steel.

Milligram weight sets 1 mg – 500 mg are supplied in a separate plastic case

Weight	Plastic case		Aluminium case		Wooden case		DAkkS certificate	
	KERN 	€	KERN 	€	KERN 	€	KERN	€
1 mg - 500 mg	338-22	143,-	328-226	195,-	338-22	143,-	962-450	100,-
1 mg - 50 g	333-024	340,-	333-026	345,-	333-02	350,-	962-401	167,-
1 mg - 100 g	333-034	375,-	333-036	380,-	333-03	385,-	962-402	178,-
1 mg - 200 g	333-044	460,-	333-046	465,-	333-04	470,-	962-403	199,-
1 mg - 500 g	333-054	520,-	333-056	530,-	333-05	540,-	962-404	210,-
1 mg - 1 kg	333-064	640,-	333-066	650,-	333-06	660,-	962-405	220,-
1 mg - 2 kg	333-074	900,-	333-076	910,-	333-07	920,-	962-406	250,-
1 mg - 5 kg	333-084	1150,-	333-086	1180,-	333-08	1190,-	962-407	265,-
1 mg - 10 kg	-	-	333-096	1640,-	333-09	1650,-	962-408	285,-
1 g - 50 g	334-024	210,-	326-026	280,-	334-02	220,-	962-415	67,-
1 g - 100 g	334-034	250,-	326-036	320,-	334-03	260,-	962-416	77,-
1 g - 200 g	334-044	340,-	326-046	420,-	334-04	350,-	962-417	98,-
1 g - 500 g	334-054	400,-	326-056	540,-	334-05	410,-	962-418	109,-
1 g - 1 kg	334-064	520,-	326-066	650,-	334-06	540,-	962-419	119,-
1 g - 2 kg	334-074	790,-	326-076	1010,-	334-07	810,-	962-420	151,-
1 g - 5 kg	334-084	1030,-	326-086	1390,-	334-08	1070,-	962-421	166,-
1 g - 10 kg	-	-	326-096	1830,-	334-09	1530,-	962-421	182,-

Test weights and cases

Class M1

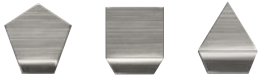

Milligram weights,
flat polyagonal sheet



Individual weights / Weight sets,
knob shape, finely turned
stainless steel or finely turned brass



Hook weights,
finely turned brass (stainless
steel, on request)

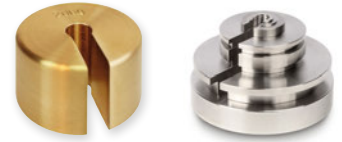

Slotted weights,
finely turned stainless steel or
finely turned brass



Plastic box, for individual
weights ≤ 200 g, for hook
weights and slotted
weights ≤ 50 g



Plastic box, lined, for
individual weights ≥ 500 g,
for hook weights and
slotted weights ≥ 100 g



Aluminium box, lined,
for individual weights



Wooden box, for individual
weights ≤ 500 g



Wooden box, lined, for
individual weights ≥ 1 kg



Plastic case, lined, for weight sets,
knob shape, stainless steel or
finely turned brass



Aluminium case, lined, for weight
sets, knob shape, stainless steel or
finely turned brass



Wooden case, for weight sets,
knob shape, finely turned
stainless steel



Wooden case, for weight sets,
knob shape, finely turned brass



Test weight (10 – 50 kg),
finely turned stainless steel, in wooden box



Beam bars, for fixing slotted weights,
aluminium or finely turned brass

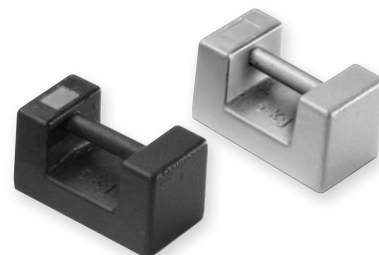

Block weights,
lacquered cast iron/stainless steel

Class M1 · Milligram weights, flat polygonal sheet

Test weight material: Aluminium 1 mg – 5 mg/German silver 10 mg – 500 mg

Weight	Tol +/- mg	Wire shape		Plastic box		Aluminium box		Wooden box		DAkkS certificate	
		KERN	€	KERN	€	KERN	€	KERN	€	KERN	€
1 mg	0,20	348-01	3,90	347-009-400	2,-	317-009-600	14,-	338-090-200	16,-	962-651	18,-
2 mg	0,20	348-02	3,90	347-009-400	2,-	317-009-600	14,-	338-090-200	16,-	962-652	18,-
5 mg	0,20	348-03	3,90	347-009-400	2,-	317-009-600	14,-	338-090-200	16,-	962-653	18,-
10 mg	0,25	348-04	3,90	347-009-400	2,-	317-009-600	14,-	338-090-200	16,-	962-654	18,-
20 mg	0,30	348-05	3,90	347-009-400	2,-	317-009-600	14,-	338-090-200	16,-	962-655	18,-
50 mg	0,40	348-06	3,90	347-009-400	2,-	317-009-600	14,-	338-090-200	16,-	962-656	18,-
100 mg	0,50	348-07	4,00	347-009-400	2,-	317-009-600	14,-	338-090-200	16,-	962-657	18,-
200 mg	0,60	348-08	4,00	347-009-400	2,-	317-009-600	14,-	338-090-200	16,-	962-658	18,-
500 mg	0,80	348-09	4,20	347-009-400	2,-	317-009-600	14,-	338-090-200	16,-	962-659	18,-

Class M1 · Individual weights, knob shape, finely turned brass or stainless steel

Weight	Tol +/- mg	Individual weight, finely turned brass		Individual weight, finely turned stainless steel		Plastic box		Aluminium box		Wooden box		DAkkS certificate	
		KERN	€	KERN	€	KERN	€	KERN	€	KERN	€	KERN	€
1 g	1,0	347-41	4,-	347-01	4,60	347-030-400	2,-	317-010-600	14,-	337-010-200	14,-	962-631	15,-
2 g	1,2	347-42	4,20	347-02	4,90	347-030-400	2,-	317-020-600	14,-	337-020-200	14,-	962-632	15,-
5 g	1,6	347-43	4,60	347-03	5,40	347-030-400	2,-	317-030-600	14,-	337-030-200	14,-	962-633	15,-
10 g	2,0	347-44	5,10	347-04	5,60	347-050-400	2,-	317-040-600	14,-	337-040-200	14,-	962-634	15,-
20 g	2,5	347-45	6,30	347-05	6,50	347-050-400	2,-	317-050-600	14,-	337-050-200	14,-	962-635	15,-
50 g	3,0	347-46	7,50	347-06	8,20	347-070-400	2,-	317-060-600	14,-	337-060-200	15,-	962-636	15,-
100 g	5,0	347-47	9,50	347-07	11,-	347-070-400	2,-	317-070-600	14,-	337-070-200	15,-	962-637	16,-
200 g	10	347-48	13,-	347-08	15,-	347-080-400	2,-	317-080-100	28,-	337-080-200	16,-	962-638	16,-
500 g	25	347-49	28,-	347-09	31,-	347-090-400	3,-	317-090-100	29,-	337-090-200	19,-	962-639	16,-
1 kg	50	347-51	43,-	347-11	51,-	347-110-400	3,-	317-110-100	35,-	337-110-200	24,-	962-641	16,-
2 kg	100	347-52	77,-	347-12	85,-	347-120-400	3,-	317-120-100	44,-	337-120-200	27,-	962-642	17,-
5 kg	250	347-53	165,-	347-13	188,-	347-130-400	9,-	317-130-100	66,-	337-130-200	47,-	962-643	17,-
10 kg	500	347-54	310,-	347-14	365,-	347-140-400	9,-	317-140-100	89,-	337-140-200	60,-	962-644	17,-

Class M1 · Test weights, stainless steel, stackable

Test weight material: finely turned stainless steel

Weight	Tol +/- mg	Dimensions ø × H	Test weight		Wooden case		DAkkS certificate	
			KERN	€	KERN	€	KERN	€
10 kg	500	137×132 mm	347-141	490,-	337-141-200	190,-	962-644	17,-
20 kg	1000	137×217 mm	347-151	590,-	337-151-200	235,-	962-645	22,-
50 kg	2500	198×250 mm	347-161	1600,-	337-161-200	345,-	962-646	24,-



Note

We also offer a large range of heavy-duty weights in other materials, for example, stainless steel and in other forms, for example, discs or individual weight containers, please ask for details.

Class M1 · Weight sets, knob shape, finely turned brass or stainless steel

Test weight material: Milligram weights Aluminium/German silver, individual weights finely turned brass or stainless steel.
Milligram weight sets 1 mg – 500 mg are supplied in a separate plastic case

Weight	Knob shape, finely turned brass, in plastic case		Knob shape, finely turned stainless steel, in plastic case		Knob shape, finely turned brass, in wooden case		Knob shape, shape, finely turned stainless steel, in wooden case		Knob shape, finely turned brass, in aluminium case		Knob shape, finely turned stainless steel, in aluminium case		DAkkS certificate	
	KERN	€	KERN	€	KERN	€	KERN	€	KERN	€	KERN	€	KERN	€
1 mg - 500 mg	348-22	69,-	348-22	69,-	348-22	69,-	348-22	69,-	328-226	195,-	328-226	195,-	962-650	63,-
1 mg - 50 g	343-424	149,-	343-024	160,-	343-42	149,-	343-02	155,-	343-026	160,-	343-426	149,-	962-601	106,-
1 mg - 100 g	343-434	162,-	343-034	170,-	343-43	162,-	343-03	170,-	343-036	170,-	343-436	162,-	962-602	112,-
1 mg - 200 g	343-444	191,-	343-044	205,-	343-44	191,-	343-04	205,-	343-046	205,-	343-446	191,-	962-603	125,-
1 mg - 500 g	343-454	220,-	343-054	245,-	343-45	220,-	343-05	245,-	343-056	240,-	343-456	220,-	962-604	131,-
1 mg - 1 kg	343-464	330,-	343-064	335,-	343-46	330,-	343-06	335,-	343-066	330,-	343-466	330,-	962-605	137,-
1 mg - 2 kg	343-474	485,-	343-074	540,-	343-47	485,-	343-07	540,-	343-076	530,-	343-476	485,-	962-606	152,-
1 mg - 5 kg	343-484	710,-	343-084	740,-	343-48	710,-	343-08	800,-	343-086	730,-	343-486	710,-	962-607	160,-
1 mg - 10 kg	-	-	-	-	343-49	1090,-	343-09	1250,-	-	-	-	-	962-608	167,-
1 g - 50 g	344-424	94,-	344-024	95,-	344-42	94,-	344-02	92,-	343-096	1180,-	344-426	104,-	962-615	42,-
1 g - 100 g	344-434	100,-	344-034	107,-	344-43	100,-	344-03	102,-	344-026	125,-	344-436	110,-	962-616	49,-
1 g - 200 g	344-444	126,-	344-044	139,-	344-44	126,-	344-04	139,-	344-036	135,-	344-446	136,-	962-617	61,-
1 g - 500 g	344-454	158,-	344-054	179,-	344-45	158,-	344-05	179,-	344-046	155,-	344-456	168,-	962-618	68,-
1 g - 1 kg	344-464	280,-	344-064	285,-	344-46	280,-	344-06	285,-	344-056	185,-	344-466	280,-	962-619	74,-
1 g - 2 kg	344-474	430,-	344-074	465,-	344-47	430,-	344-07	490,-	344-066	285,-	344-476	430,-	962-620	89,-
1 g - 5 kg	344-484	650,-	344-084	720,-	344-48	650,-	344-08	750,-	344-076	465,-	344-486	650,-	962-621	96,-
1 g - 10 kg	-	-	-	-	344-49	1020,-	344-09	1190,-	344-086	720,-	344-496	1020,-	962-622	104,-

Newton weights (N)

All hook and slotted weights as well as beam bars are available with N adjustment according to M1 tolerances, additional price € 8,-/pc. We need to know the location of use and postal code.

DAkkS calibration certificate for N weights: identical to DAkkS prices for individual weights M1, additional price € 8,-.

Class M1 · Hook weights, finely turned brass

Weight	Tol +/- mg	Hook weight, finely turned brass		Plastic box, lined		DAkkS certificate	
		KERN	€	KERN	€	KERN	€
1 g	1,0	347-416	14,-	347-030-400	2,-	962-631	15,-
2 g	1,2	347-426	15,-	347-030-400	2,-	962-632	15,-
5 g	1,6	347-436	15,-	347-030-400	2,-	962-633	15,-
10 g	2,0	347-446	15,-	347-050-400	2,-	962-634	15,-
20 g	2,5	347-456	16,-	347-050-400	2,-	962-635	15,-
50 g	3,0	347-466	20,-	347-070-400	2,-	962-636	15,-
100 g	5,0	347-476	23,-	347-090-400	3,-	962-637	16,-
200 g	10,0	347-486	31,-	347-090-400	3,-	962-638	16,-
500 g	25,0	347-496	46,-	347-110-400	3,-	962-639	16,-
1 kg	50,0	347-516	66,-	347-120-400	3,-	962-641	16,-
2 kg	100,0	347-526	107,-	347-130-400	9,-	962-642	17,-
5 kg	250,0	347-536	200,-	347-140-400	9,-	962-643	17,-
10 kg	500,0	347-546	350,-	-	-	962-644	17,-



Note

Stainless steel hook weights, on request

Class M1 · Slotted weights, finely turned brass

Weight	Tol +/- mg	Finely turned brass		Plastic box, lined		DAkkS certificate	
		KERN	€	KERN	€	KERN	€
1 g	1,0	347-415	14,-	347-030-400	2,-	962-631	15,-
2 g	1,2	347-425	14,-	347-030-400	2,-	962-632	15,-
5 g	1,6	347-435	15,-	347-030-400	2,-	962-633	15,-
10 g	2,0	347-445	17,-	347-030-400	2,-	962-634	15,-
20 g	2,5	347-455	20,-	347-080-400	2,-	962-635	15,-
50 g	3,0	347-465	22,-	347-080-400	2,-	962-636	15,-
100 g	5,0	347-475	25,-	347-090-400	3,-	962-637	16,-
200 g	10	347-485	30,-	347-090-400	3,-	962-638	16,-
500 g	25	347-495	48,-	347-110-400	3,-	962-639	16,-
1 kg	50	347-515	77,-	347-130-400	9,-	962-641	16,-
2 kg	100	347-525	118,-	347-130-400	9,-	962-642	17,-
5 kg	250	347-535	215,-	347-140-400	9,-	962-643	17,-
10 kg	500	347-545	375,-	347-140-400	9,-	962-644	17,-

Class M1 · Beam bars, for fixing slotted weights

Own weight beam bar	Maximum total load(1)	Largest slotted weight possible	Material	DAkkS certificate			
				KERN	€		
10 g	200 g	100 g	Aluminium	347-445-100*	30,-	962-634	15,-
100 g	2 kg	1 kg	Brass	347-475-100**	50,-	962-637	16,-
500 g	20 kg	10 kg	Brass	347-495-100***	77,-	962-639	16,-
1 kg	40 kg	10 kg	Brass	347-515-100***	114,-	962-641	16,-

(1) is exclusive of the own weight of the beam bar, e.g. the maximum possible total weight is calculated from "Maximum total load" + "own weight beam bar"



Class M1 · Block weights, lacquered cast iron / stainless steel

Weight	Tol +/- mg	Lacquered cast iron		Stainless steel		DAkkS certificate	
		KERN	€	KERN	€	KERN	€
5 kg	0,25	346-86	71,-	346-06	315,-	962-643	17,-
10 kg	0,50	346-87	95,-	346-07	455,-	962-644	17,-
20 kg	1,00	346-88	118,-	346-08	580,-	962-645	22,-
50 kg	2,50	346-89	400,-	346-09	1490,-	962-646	24,-

Note

We also offer rectangular weights in OIML classes F1 and F2, please ask for details.

Class M1 · Heavy duty weights, cast iron, stackable

Designed to be lifted with forklift trucks or cranes, delivery time is approx. 4 weeks

Dimensions: see internet on www.kern-sohn.com

Weight	Tol +/- g	Heavy duty weight, lacquered cast iron		DAkkS certificate	
		KERN	€	KERN	€
100 kg	5	346-81	1390,-	962-691	63,-
200 kg	10	346-82	1800,-	962-692	63,-
500 kg	25	346-83	3350,-	962-693	63,-
1000 kg	50	346-84	5500,-	962-694	136,-
2000 kg	100	346-85	10300,-	962-695	250,-



Note

We also offer a large range of heavy-duty weights in other materials, for example, stainless steel and in other forms, for example, discs or individual weight containers, please ask for details.

Test weights and cases

Classes M2 · M3



Individual weights / Weight sets,
knob shape, finely turned brass



Individual weights / Weight sets,
knob shape, lacquered cast iron



Block weights,
lacquered cast iron



Plastic box, lined,
for individual weights



Aluminium box, lined,
for individual weights



Wooden box,
for individual weights ≤ 500 g,
*not appropriate for cast iron
weights



Wooden box, lined
for individual weights ≥ 1 kg



Plastic case, lined, for weight sets
knob shape, stainless steel or
finely turned brass



Aluminium case, lined, for weight
sets knob shape, finely turned
brass / lacquered cast iron



Wooden case,
for weight sets knob shape,
finely turned brass





Wooden case,
for weight sets knob shape,
lacquered cast iron



Aluminium case, lined,
for block weights,

Class M2 · Individual weights, knob shape, finely turned brass

Weight	Tol +/- mg	Knob shape, finely turned brass		Plastic box, lined		Aluminium box		Wooden box		DAkkS certificate	
		KERN	€	KERN 	€	KERN 	€	KERN 	€	KERN	€
1 g	3	357-41	3,50	347-030-400	2,-	317-010-600	14,-	337-010-200	14,-	962-631	15,-
2 g	4	357-42	3,70	347-030-400	2,-	317-020-600	14,-	337-020-200	14,-	962-632	15,-
5 g	5	357-43	4,10	347-030-400	2,-	317-030-600	14,-	337-030-200	14,-	962-633	15,-
10 g	6	357-44	4,40	347-050-400	2,-	317-040-600	14,-	337-040-200	14,-	962-634	15,-
20 g	8	357-45	6,30	347-050-400	2,-	317-050-600	14,-	337-050-200	14,-	962-635	15,-
50 g	10	357-46	7,40	347-070-400	2,-	317-060-600	14,-	337-060-200	15,-	962-636	15,-
100 g	16	357-47	9,50	347-070-400	2,-	317-070-600	14,-	337-070-200	15,-	962-637	16,-
200 g	30	357-48	13,-	347-080-400	2,-	317-080-600	14,-	337-080-200	16,-	962-638	16,-
500 g	80	357-49	26,-	347-090-400	3,-	317-090-600	14,-	337-090-200	19,-	962-639	16,-
1 kg	160	357-51	41,-	347-110-400	3,-	317-110-600	24,-	337-110-200	24,-	962-641	16,-
2 kg	300	357-52	69,-	347-120-400	3,-	317-120-600	27,-	337-120-200	27,-	962-642	17,-
5 kg	800	357-53	149,-	347-130-400	9,-	317-130-600	47,-	337-130-200	47,-	962-643	17,-
10 kg	1600	357-54	295,-	347-140-400	9,-	317-140-600	65,-	337-140-200	60,-	962-644	17,-

Class M2 · Heavy duty weights, lacquered cast iron

Weight	Tol +/- g	Heavy duty weight, lacquered cast iron		DAkkS certificate	
		KERN	€	KERN	€
5 kg	0,8	356-86	65,-	962-643	17,-
10 kg	1,6	356-87	90,-	962-644	17,-
20 kg	3,0	356-88	113,-	962-645	22,-
50 kg	8,0	356-89	390,-	962-646	24,-

Klasse M2 · Weight sets, knob shape, finely turned brass

Weight	Knob shape, finely turned brass, in aluminium case		Knob shape, finely turned brass, in wooden case		DAkkS certificate	
	KERN	€	KERN	€	KERN	€
1 g - 50 g	354-426	105,-	354-42	76,-	962-615	42,-
1 g - 100 g	354-436	106,-	354-43	86,-	962-616	49,-
1 g - 200 g	354-446	135,-	354-44	119,-	962-617	61,-
1 g - 500 g	354-456	156,-	354-45	153,-	962-618	68,-
1 g - 1 kg	354-466	240,-	354-46	240,-	962-619	74,-
1 g - 2 kg	354-476	390,-	354-47	390,-	962-620	89,-
1 g - 5 kg	354-486	590,-	354-48	590,-	962-621	96,-
1 g - 10 kg	354-496	940,-	354-49	940,-	962-622	104,-

Class M3 · Individual weights, knob shape, finely turned brass

Weight	Tol +/- mg	Finely turned brass		Plastic box, lined		Aluminium box		Wooden box		DAkkS certificate	
		KERN	€	KERN	€	KERN	€	KERN	€	KERN	€
1 g	10	367-41	3,00	347-030-400	2,-	317-010-600	14,-	317-010-100	26,-	962-631	15,-
2 g	12	367-42	3,40	347-030-400	2,-	317-020-600	14,-	317-020-100	26,-	962-632	15,-
5 g	16	367-43	3,80	347-030-400	2,-	317-030-600	14,-	317-030-100	26,-	962-633	15,-
10 g	20	367-44	4,20	347-050-400	2,-	317-040-600	14,-	317-040-100	26,-	962-634	15,-
20 g	25	367-45	5,60	347-050-400	2,-	317-050-600	14,-	317-050-100	26,-	962-635	15,-
50 g	30	367-46	6,80	347-070-400	2,-	317-060-600	14,-	317-060-100	27,-	962-636	15,-
100 g	50	367-47	8,90	347-070-400	2,-	317-070-600	14,-	317-070-100	28,-	962-637	16,-
200 g	100	367-48	13,00	347-080-400	2,-	317-080-600	14,-	317-080-100	28,-	962-638	16,-
500 g	250	367-49	25,00	347-090-400	3,-	317-090-600	14,-	317-090-100	29,-	962-639	16,-
1 kg	500	367-51	37,00	347-110-400	3,-	317-110-600	24,-	317-110-100	35,-	962-641	16,-
2 kg	1000	367-52	68,00	347-120-400	3,-	317-120-600	27,-	317-120-100	44,-	962-642	17,-

Class M3 · Individual weights, cylindrical shape, lacquered cast iron

Weight	Tol +/- g, kg	Lacquered cast iron		DAkkS certificate	
		KERN	€	KERN	€
100 g *	100 g	366-91	12,-	962-637	16,-
200 g *	200 g	366-92	13,-	962-638	16,-
500 g **	500 g	366-93	19,-	962-639	16,-
1 kg **	1 kg	366-94	25,-	962-641	16,-
2 kg **	2 kg	366-95	44,-	962-642	17,-
5 kg **	5 kg	366-96	75,-	962-643	17,-
10 kg **	10 kg	366-97	135,-	962-644	17,-



Class M3 · Block weights, lacquered cast iron

Weight	Tol +/- g	Lacquered cast iron		DAkkS certificate	
		KERN	€	KERN	€
5 kg	2,5	366-86	64,-	962-643	17,-
10 kg	5,0	366-87	89,-	962-644	17,-
20 kg	10	366-88	112,-	962-645	22,-
50 kg	25	366-89	380,-	962-646	24,-

Class M3 · Weight sets, cylindrical shape, brass and lacquered cast iron

Weight	Weight set in wooden block		DAkkS certificate	
	KERN	€	KERN	€
1 g - 1 kg	362-96	160,-	962-619	74,-
1 g - 2 kg	362-97	260,-	962-620	89,-
1 g - 5 kg	362-98	350,-	962-621	96,-
1 g - 10 kg	362-99	500,-	962-622	104,-



Individual weights ≤ 50 g

Individual weights 100 g and 200 g

Individual weights ≥ 500 g

Tweezers, weight grips, gloves, dusting brush



Tweezers					
to be able to safely grip small test weights					
For class	For weight	Length	Version	KERN	€
E1 - M3	1 mg - 200 g	105 mm	1 Stainless steel with silicone-coated tips	315-243	14,-
E1 - M3	500 g - 2 kg	250 mm	1 Stainless steel with silicone-coated tips	315-245	32,-
E1 - M3	≤ 5 g	130 mm	2 Stainless steel, curved, high quality carbon tips	315-246	22,-
E1 - M3	≤ 5 g	136 mm	3 Stainless steel, straight, high quality carbon tips	315-247	22,-
E1 - M3	≤ 200 g	225 mm	4 Stainless steel, straight, high-quality carbon tips, with a special shape for gripping weights of various shapes and sizes	315-248	30,-
F2 - M3	1 mg - 200 g	100 mm	5 Stainless steel	335-240	8,00
E1 - M3	1 mg - 200 g	100 mm	6 Plastic	315-242	6,20

Weight grip plastic coated			
For class	For knob shape	KERN	€
E1 - M3		2 kg 315-273	22,-
E1 - M3		5 kg 315-274	30,-
E1 - M3		10 kg 315-275	35,-
E1 - M3		20 kg 315-276	42,-



Gloves
cotton, 1 pair. Help to protect the test weights when being used daily, from grease from fingers, damp etc.

KERN €
317-280 2,50



Gloves
leather/cotton, 1 pair. Help to protect the test weights when being used daily, from grease from fingers, damp etc.

KERN €
317-290 6,90



Premium gloves
Nylon, 1 pair. Particularly elastic, one size fits all, with special fingertip coating to ensure a safe grip. Helps to protect the test weights in everyday use from grease from fingers, damp etc.

KERN €
317-281 11,-



Dusting brush
to clean the weights

KERN €
318-270 2,50



Bellows
for cleaning weights

KERN €
318-271 7,-



Microfibre cloth
for cleaning weights

KERN €
318-272 3,50

Boxes for individual weights



For weights ≤ 500 g, OIML class E1 - F1



For weights ≤ 500 g, OIML class F2 - M3



For weights ≥ 10 kg, OIML class F2 - M1



For weights ≥ 1 kg, OIML class E1 - F1



For weights ≥ 1 kg



For weights ≥ 10 kg, OIML class E1 - F2

Box material: Lined wood
Suitable for individual weights
KERN-No. 307, 316, 317, 326, 327, 329

Box material: Wood
Suitable for individual weights
KERN-No. 337, 347, 357, 367

Wooden box, lined
for individual weights E1 - F1

For weights	KERN		€
mg	338-090-200		16,-
1 g	317-010-100		26,-
2 g	317-020-100		26,-
5 g	317-030-100		26,-
10 g	317-040-100		26,-
20 g	317-050-100		26,-
50 g	317-060-100		27,-
100 g	317-070-100		28,-
200 g	317-080-100		28,-
500 g	317-090-100		29,-
1 kg	317-110-100		35,-
2 kg	317-120-100		44,-
5 kg	317-130-100		66,-
10 kg	317-140-100		89,-
20 kg	317-150-100		340,-
50 kg	317-160-100		415,-

Wooden box
for individual weights F2 - M3

For weights	KERN		€
mg	338-090-200		16,-
1 g	337-010-200		14,-
2 g	337-020-200		13,-
5 g	337-030-200		13,-
10 g	337-040-200		14,-
20 g	337-050-200		14,-
50 g	337-060-200		15,-
100 g	337-070-200		15,-
200 g	337-080-200		16,-
500 g	337-090-200		19,-
1 kg	337-110-200		24,-
2 kg	337-120-200		27,-
5 kg	337-130-200		47,-
10 kg	337-140-200		60,-
20 kg	337-150-200		220,-
50 kg	337-160-200		345,-

Wooden box
for check weights F2, M1

For weights	KERN		€
10 kg	337-141-200		190,-
20 kg	337-151-200		235,-
50 kg	337-161-200		345,-

Aluminium box, lined
for individual weights E1 - M3

For weights	KERN		€
1-500 mg (set)	313-010-600		75,-
Individual weight, mg	317-009-600		14,-
1 g	317-010-600		14,-
2 g	317-020-600		14,-
5 g	317-030-600		14,-
10 g	317-040-600		14,-
20 g	317-050-600		14,-
50 g	317-060-600		14,-
100 g	317-070-600		14,-
200 g	317-080-600		14,-
500 g	317-090-600		19,-
1 kg	317-110-600		24,-
2 kg	317-120-600		27,-
5 kg	317-130-600		47,-

Aluminium box, lined
for individual weights, knob shape, class E1 - M3

Largest possible weight	KERN		€
10 kg	317-140-600		65,-
20 kg	317-150-600		205,-
50 kg	317-160-600		250,-

Aluminium case, lined
for individual weights F2 - M3

For weights	KERN		€
5 g	346-060-600		180,-
10 g	346-070-600		180,-
20 g	346-080-600		220,-



For weights ≤ 5 kg, OIML class E1 - M3

Case material: Lined aluminium
Suitable for block weights
KERN-Nr. 346, 356, 366

Cases/boxes for individual weight sets

Individual weight sets:

You can create your own "tailor-made" individual weight sets yourself. KERN will customise your own personal wooden box/plastic carrying case. The largest individual weight which will fit is given in the table.

Sample order:

Your individual weight set:

1 × 50 g, 2 × 100 g, 1 × 500 g, 2 × 1 kg, 1 × 2 kg.

The correct individual box is **KERN-Nr. 313-080-400** (plastic) or **KERN-Nr. 315-070-100** (wood)



Plastic case

for individual weight sets classes E2 – M3, not appropriate for cast iron weights

Largest possible weight	KERN		€
≤ 500 g	313-050-400		92,-
≤ 5 kg	313-080-400		190,-

Wooden case

for individual weight sets classes E1 – F1

Largest possible weight	KERN		€
≤ 200 g	315-040-100		129,-
≤ 1 kg	315-060-100		205,-
≤ 2 kg	315-070-100		250,-
≤ 5 kg	315-080-100		350,-
≤ 10 kg	315-090-100		465,-

Wooden case

for individual weight set classes F2 – M3, not appropriate for cast iron weights

Largest possible weight	KERN		€
≤ 200 g	335-040-200		65,-
≤ 500 g	335-050-200		65,-
≤ 1 kg	335-060-200		115,-
≤ 2 kg	335-070-200		136,-
≤ 5 kg	335-080-200		210,-
≤ 10 kg	335-090-200		300,-

Plastic carrying case for standard weight sets



Aluminium case for safe storage and transportation under harsh industrial conditions.

Plastic case for weight sets

with standard denomination classes E2 – M3, not appropriate for cast iron weights

Largest possible weight	KERN		€
≤ 500 g	313-050-400		92,-
≤ 5 kg	313-080-400		190,-

Aluminium case

for weight sets with standard denomination classes E1 – M2

Largest possible weight	KERN		€
≤ 200 g	315-040-100		129,-
≤ 1 kg	315-060-100		205,-
≤ 2 kg	315-070-100		250,-
≤ 5 kg	315-080-100		350,-
≤ 10 kg	315-090-100		465,-

Weight carriers for block weights or other test weights

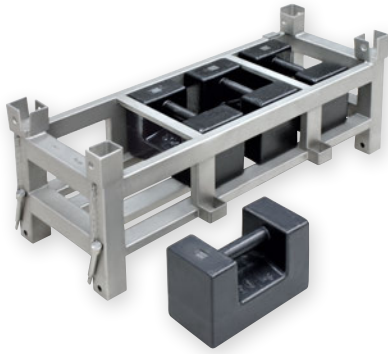

Individual weight carriers for testing high capacity floor scales, pallet scales, pallet truck scales, crane scales, etc. This can also be used for storing the weights. This means the weight container and the weights can be placed on the scale in one go, saving time and money.

The weight container can be calibrated to OIML accuracy classes M1 – M3. On request, KERN will make you a “tailor-made” weight carrier to your specifications.

Example:

9 block weights	each 50 kg, class M1 =	450 kg
1 weight container	each 50 kg, class M1 =	50 kg
Total		= 500 kg

Weight containers for rectangular weights or other test weights, calibrated to OIML class M1

Preconfigured weight containers for testing high-load floor scales, pallet scales, pallet truck scales, crane scales, etc. This can also be used for storing the weights. This means the weight container and the weights can be placed on the balance in one go, saving you time and money. The weight container is calibrated to OIML accuracy class M1. Other OIML accuracy classes are also available, please ask.

Weight of the weight container, OIML class M1	Tol +/- mg	Possible equipment, rectangular weights, OIML class M1	Maximum total weight (weight container incl. weights)	DAkkS certificate	
				KERN	€
20 kg	1000	5 × 20 kg	120 kg	346-022-005	1560,-
40 kg	1500	8 × 20 kg	200 kg	346-042-008	1840,-
50 kg	2500	10 × 20 kg	250 kg	346-052-010	1990,-
50 kg	2500	4 × 50 kg	250 kg	346-055-004	1990,-
50 kg	2500	9 × 50 kg	500 kg	346-055-009	1990,-
60 kg	3000	8 × 50 kg and 2 × 20 kg	500 kg	346-065-009	2190,-

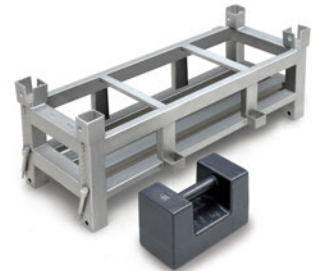

Weight of the weight container, OIML class M1	Tol +/- mg	Possible equipment, rectangular weights, OIML class M1	Maximum total weight (weight container incl. weights)	DAkkS certificate	
				KERN	€
20 kg	1000	max. 10 × 10 kg or 5 × 20 kg	120 kg	347-022-005	1560,-
40 kg	2000	max. 16 × 10 kg or 8 × 20 kg	200 kg	347-042-008	1840,-
50 kg	2500	max. 20 × 10 kg or 10 × 20 kg	250 kg	347-052-010	1990,-
60 kg	3000	max. 22 × 20 kg	500 kg	347-062-022	2190,-



Individual weight containers for rectangular weights or other test weights, calibrated to OIML class M1

Weight of the weight container, OIML class M1	DAkkS certificate	
	KERN	€
Individual weight container for rectangular weights	347-022-005	1560,-
Individual weight container for test weights	347-042-008	1840,-

DAkkS Calibration Service and Verification service



The DAkkS (German accreditation body)

The DAkkS is the national accreditation body of the Federal Republic of Germany. According to Regulation (EC) No. 765/2008 and the Accreditation Body Act (AkkStelleG), the DAkkS acts in the public interest as the sole service provider for accreditation in Germany.

In order to be able to fulfil its sovereign accreditation tasks, the DAkkS was entrusted by the Federal Government. As an entrusted body, the DAkkS is subject to federal supervision.

Only an accredited calibration laboratory can issue a DAkkS calibration certificate. This defines not only the measuring method as well as the measuring result, but also gives information on tracing the test medium to national standards and the relevant uncertainty of measurement.

- ▶ **You are certified to ...**
ISO 9001, QS 9000, GLP, GMP, TS16949
- ▶ **You need ...**
to control your measuring equipment
- ▶ **Our solution ...**
DAkkS calibration certificate; (traceability, measuring uncertainty, internationally recognised)

KERN – Precision is our business

The KERN calibration laboratory for electronic balances and weights has been accredited by DKD since 1994 and today is one of the most modern and best-equipped DKD calibration laboratories for balances, test weights and force measurement in Europe.

Thanks to the high level of automation, we can carry out DAkkS calibration of balances, test weights and force-measuring devices 24 hours a day, 7 days a week.

Do you have any further requests or questions on this matter? We would be pleased to help you or visit us on the web at www.kern-lab.com

DAkkS calibration

- Why?** DAkkS calibration is always necessary when checking equipment (balance or test weight) is to be used in a QM process (e.g. to ISO 9000ff, GS 9000, TS 16949, VDA 6.1, FDA, GLP, GMP, GMP etc.)
- What?** Any checking equipment in proper condition can be DAkkS calibrated
- How?** Determination of accuracy throughout the world by a laboratory which is accredited to DIN EN ISO 17025. Traceability to internationally recognised standards. The DAkkS calibration certificate confirms both the measurement characteristics of the checking equipment and the general requirements for the control of checking equipment.
- Where?** Internationally recognised – this is monitored by ILAC (International Laboratory Accreditation Cooperation) and e.g. DAkkS (German calibration service) in Germany
- When?** Operator control the use of checking equipment and periodic recalibration time intervals themselves

Range of services:

- DAkkS calibration of balances with a maximum load of up to 50.000 kg
- DAkkS calibration of weights in the range of 1 mg – 2.500 kg. Calibrations can be carried out in the following classes: E1, E2, F1, F2, M1, M2, M3
- DAkkS calibration of force-measuring devices
- Volume determination for weights of accuracy class E1
- Measuring of sensitivity (magnetic characteristics)
- Factory calibration in various sizes:
- Force (sensors and measuring devices), hardness (Shore, UCI, Leeb, etc.), thickness of coatings and walls, torque wrench testing devices, and much more
- Conformity assessments and recalibration of balances and weights at the KERN verification point, working closely with the verification authorities

And on top of all these services, we also offer additional services – see page 196/197.



Waldemar Fleitling

Product specialist Calibration service

Tel. +49 7433 9933-163

Fax +49 7433 9933-29163

fleitling@kern-sohn.com

Balance & weight in the quality management system

Do you already use all the modules of the KERN precision package for maximum accuracy and reliability of your balance?

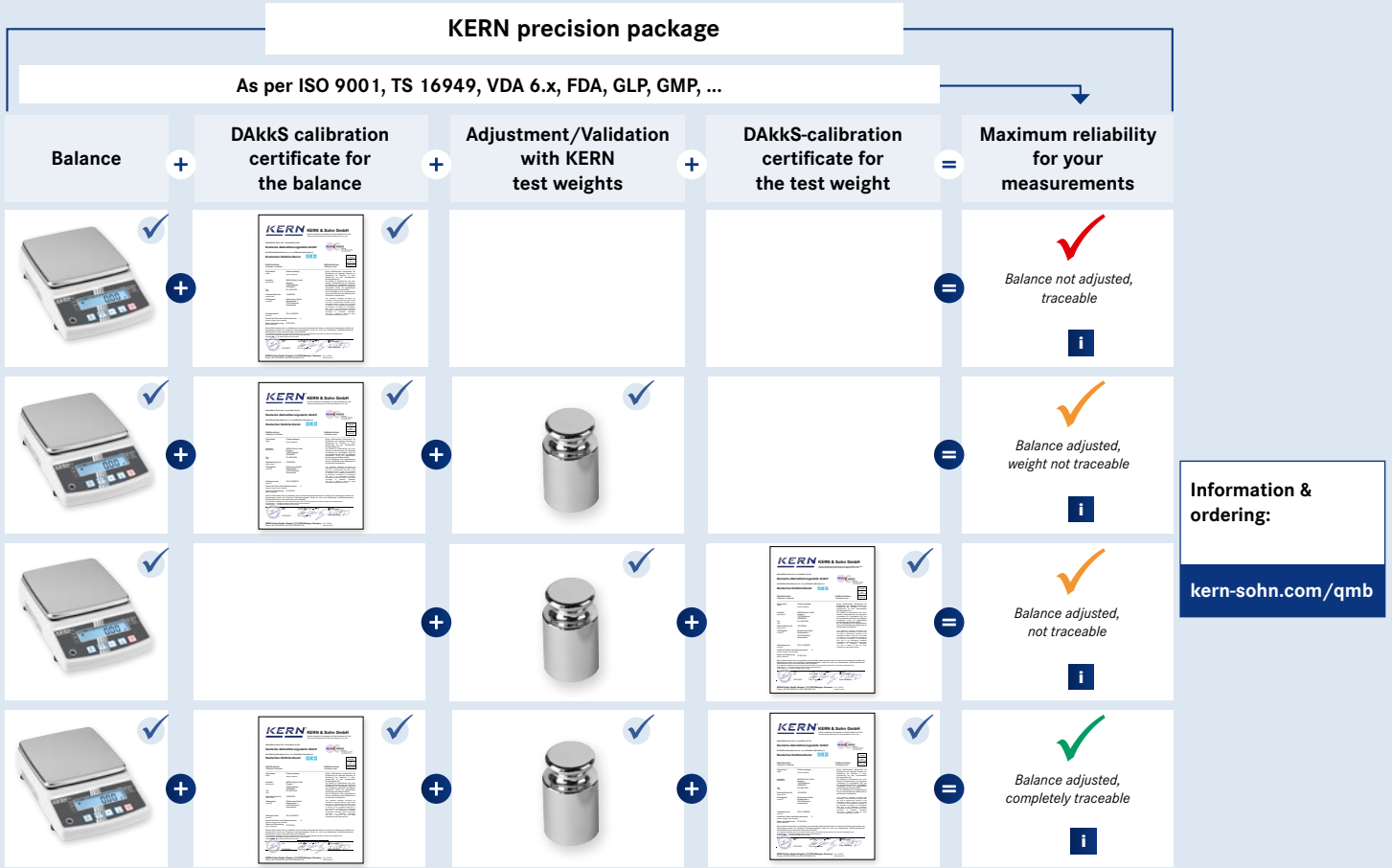

The KERN calibration laboratory (D-K-19408-01-00)

KERN has a highly-automated DAkkS laboratory with accreditation to DIN EN ISO/IEC 17025 in the field of balances, test weights and force measurement. By using the most modern calibration technology with high-end calibration robots in fully air-conditioned laboratories, the measurement uncertainty and process times are reduced to a minimum, and also the quality of the calibration is increased.

As an accredited and certified calibration service provider with decades of experience, KERN offers you an extensive range of services, which will leave no demand unfulfilled. The accreditation applies to the extent specified in the appendix to the certificate D-K-19408-01-00.

We offer the following services:

Waagen:

- ▶ DAkkS calibration up to 50 t
- ▶ Minimum sample weight (in use)
- ▶ Usage accuracy
- ▶ Adjustment at the location of installation
- ▶ Certificate of conformity
- ▶ Equipment qualification:
 - > Installation qualification (IQ)
 - > Function qualification (OQ)
 - > Performance qualification (PQ)
 - > Maintenance qualification (MQ)

Weights:

- ▶ DAkkS calibration up to 2.5 t (OIML classes E1 – M3)
- ▶ Volume determination for OIML class E1
- ▶ Measuring of sensitivity (magnetic characteristics)

Force:

- ▶ DAkkS calibration up to 5 kN

Factory calibration for:

- ▶ Force-measuring devices
 - ▶ Hardness
 - ▶ Layer thickness
 - ▶ Material thickness
 - ▶ Temperature of moisture analysers
- Authorised verification point for balances and weights (initial verification and re-verification)

Our commitment to satisfy our customers never stops. Perhaps this is one of the reasons why our roots can perhaps be traced so far back in history. **Discover the KERN route to success: fast - competent - reliable - versatile!**

The order process

- 1 You will receive a **reminder** that your test equipment is due or you will generate a quotation for new or existing test equipment
- 2 Submission or collection of your test equipment
- 3 Initial inspection of your goods, to check that they are suitable for calibration, and are complete, etc.
- 4 You will get a detailed order confirmation
- 5 Our experts will carry out initial calibration
- 6 Checked for conformity with required tolerances and if required, any necessary actions which arise from this are carried out
- 7 Before these actions are carried out, we will contact you (in so far as no individual processing has been agreed with you beforehand)
- 8 After your approval the necessary actions will be implemented and the calibration will be completed
- 9 After that your test equipment will be returned without delay, together with the appropriate calibration certificates
- 10 We will monitor your recalibration periods and will send you, free of charge, a reminder about your next calibration

Our service

► Reminder service

The continuous cyclic recalibration of your checking equipment is an integral part of the reliable management of test equipment. You can depend on us to support you, and we will remind you in good time, free of charge, when the next recalibration is due. In addition, you have the option of managing your test equipment yourself online (cf. 1, 10).

► Quote generator

You will be impressed by our price-to-performance ratio. Request a non-binding quotation or create it yourself to suit your specifications at www.kern-lab.com (cf. 1)

► Collection service

We will be pleased to arrange for our shipping company to pick up the goods from your premises. Simply tell us the weight and dimensions of your package and leave the rest to us (cf. 2)

► Repair and reconditioning of balances and weights

KERN will get your weights back up to standard, regardless of the manufacturer. Whether it is adjustment, marking, sand blasting or lacquering - the aim here is compliance and long-term stability. Any repairs of balances and instruments which may be necessary can be carried out quickly and easily (cf. 5, 6)

► Individual processing

In order to avoid delays with future orders, we would be pleased to incorporate your individual requirements for future processing of such calibration results. Even for smaller issues such as the printing of calibration certificates (stapling, punching, double-sided) we can work to your requirements (cf. 8).

► Express service and dispatch

If you need a particularly fast service, you can use your DAkkS express service. You will receive your test equipment after just 2 days (cf. 9).

www.kern-lab.com – the central portal for everything you need to know about the extensive KERN calibration services

On our website you will always find the latest news and useful information about testing and measuring devices, calibration, legal metrology and expansions to our range of services. You will also find numerous online services on the website.

Database supported management of test equipment

Information on your test equipment which has been calibrated by us is stored in our database. In this way it is possible to make trend calculations. You will therefore get an overview of the long-term stability and trend behaviour of your test equipment and the necessary recalibration period can easily be determined and specified.

Paperless documentation

So that there is no administrative effort, we can handle all calibration documentation in a paperless process. From quotation, through to order confirmation, delivery note and invoice right up to calibration certificate, you will receive all documents by e-mail or you can retrieve them online. Would you prefer to receive your certificate or your invoice, for example, in paper form? Of course this is not a problem either. We will send you everything you require by post.

Calibration certificate download

Using our download service you can easily download your calibration certificates as soon as the calibration work is complete and you will have access to them at any time in the future. Simply create your user account on www.kern-lab.com and you will never need to look for your certificates again.

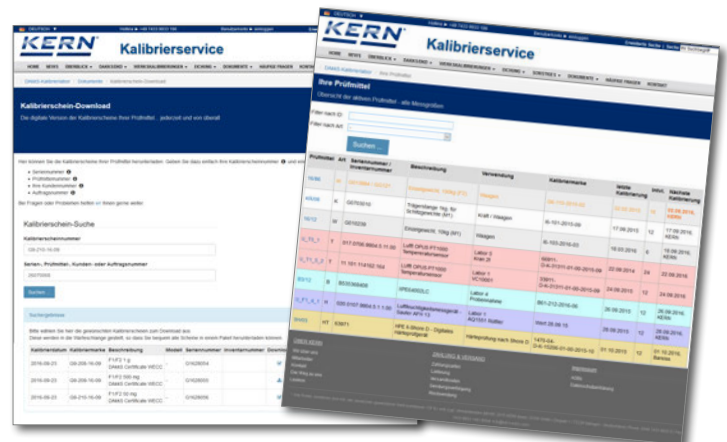

DAkkS Calibration of balances

Any balance will only give correct results if it is checked regularly, i.e. calibrated correctly and adjusted when required. A balance is only a reliable measuring and checking tool if it is calibrated and this calibration is documented. The issued DAkkS calibration certificates are proof of the metrological traceability to national and international standards, as required by the DIN EN ISO 9000 and DIN EN ISO/IEC 17025 standards, amongst others. KERN recommends a recalibration period of one year. The standard does not give a defined recalibration period. KERN recommends that, with intensive (daily) use, you recalibrate your balance every 6 months and with normal (weekly) use, every 12 months.

THE ADVANTAGES OF USING THE KERN IN-HOUSE CALIBRATION:



- + **Short calibration time:** Test time in the laboratory is only four working days
- + **Competence:** Calibration laboratory, which complies with the highest standards in the area of metrology
- + **Independent management** of the recalibration calendar for your individual measuring instrument is possible
- + **Cross-brand service:** Measuring devices from any manufacturer can be calibrated independently
- + **Repair:** Any necessary repairs can be carried out immediately, if you wish



a) Calibration at the KERN factory (you send your balance to us)

Recommended for new devices and for balances which can be affordably transported, as then there is no need for us to travel to carry out the calibration on-site. Repairs can be carried out at the same time, quickly and in full.

The process would be as follows:

- Day 1: Send your balance to the KERN calibration laboratory in Balingen.
- Day 2 to 3: Evaluation and calibration of your balance by our specialists.
- Day 4: After positive validation, your balance is returned.

THE ADVANTAGES OF USING THE KERN ON-SITE CALIBRATION:



- + **Calibration on-site** at your premises in the field of use
- + **No risk of damage** during transportation
- + **Low downtime**
- + **Cross-brand servicing**, basic inspection and adjustment by a specialist
- + You tell us **when you would like us to come**
- + **Device training** for qualified users



b) KERN on-site calibration (we visit you)

In Germany, KERN has a close-knit network of KERN DAkkS calibration laboratory employees, who can carry out on-site calibration of balances up to 50 tonnes.

This on-site testing service is metrologically recommended, as your balance is in its field of use and can be calibrated without any possible transportation problems.

Lower downtime and personal contact with our expert are the major benefits of this service.

Preparatory maintenance work by agreement. Prices for on-site calibration on request.

You tell us when you would like us to come, giving us details of the balances to be tested. Our on-site DAkkS calibration team will then get in touch with you immediately and will discuss the process with you at your premises – it's straight forward and professional.

This KERN calibration service is also independent of the brand.

KERN & Sohn GmbH
 Älteste europäische Feinwaagen und Gewichtefabrik seit 1844
 Oldest European Manufacturer of Precision Balances since 1844

akkreditiert durch die / accredited by the
Deutsche Akkreditierungsstelle GmbH
 als Kalibrierlaboratorium im / as calibration laboratory in
Deutschen Kalibrierdienst DKD

Kalibrierschein
 Calibration Certificate

Gegenstand
 Object

Präzisionswaage
 Precision Balance

Hersteller
 Manufacturer

Typ
 Type

Fabrikate/Serien-Nr.
 Serial number

Kalibrierzeichen
 Calibration mark

Sample
 D-K-
 19408-01-00
 2014-05

Dieser Kalibrierschein dokumentiert die Rückführung auf nationale Normale zur Darstellung der Einheiten in Übereinstimmung mit dem internationalen Einheitensystem (SI). Die DAkkS ist Unterzeichner der multilateralen Übereinkommen der European co-operation for Accreditation (EA) und der International Laboratory Accreditation Cooperation (ILAC) zur gegenseitigen Anerkennung der Kalibrierdienste. Für die Einhaltung einer angemessenen Erst- und Wiederholkalibrierung ist

Messergebnisse / Measurement results

1. Wiederholbarkeit / Repeatability

Messung	Prüflast	Waagenanzeige
Measuring	Load	Indication
No. 1	500 g	499,999 g
No. 2	500 g	499,999 g
No. 3	500 g	500,000 g
No. 4	500 g	500,000 g
No. 5	500 g	500,000 g

Standardabweichung: $s = 0,0006$
 Standard deviation:

2. Richtigkeit / Linearity

Prüflast	Waagenanzeige
Load	Indication
100 g	100,000 g
200 g	200,000 g
300 g	300,001 g
500 g	500,000 g
600 g	600,001 g

3. Außermittige Belastung / Eccentricity

Position	Prüflast	Waagenanzeige
Position	Load	Indication
No. 1	500 g	500,000 g
No. 2	500 g	499,999 g
No. 3	500 g	500,001 g
No. 4	500 g	500,001 g
No. 5	500 g	500,001 g

Messunsicherheit U / Measuring uncertainty U

Last	Abweichung	Erweiterungs-faktor k	Unsicherheit	relative Unsicherheit
Load	Error	Coverage factor	Uncertainty	Rel. uncertainty
100 g	0,000 g	2,38	0,0016 g	0,00154 %
200 g	0,000 g	2,32	0,0016 g	0,00078 %
300 g	0,001 g	2,24	0,0017 g	0,00053 %
500 g	0,000 g	2,12	0,0018 g	0,00036 %
600 g	0,001 g	2,08	0,0020 g	0,00032 %

Darstellung im Diagramm / Representation as chart

Nettolastung / Net-Load in g

Verwendungsgenauigkeit G / Usage accuracy G

Diagramm der Verwendungsgenauigkeit / Graph of usage accuracy:

$$G = 0,0013 \text{ g} + 8,72 \cdot 10^{-6} \cdot m_w$$

m_w = Nettoanzeige bei zunehmender Belastung
 net display with increasing load

Last / Load in g

rel. Meßunsicherheit

Nettolastung

Mindesteinwaage / Minimum weight of sample

—■— G Prozessgenauigkeit / Process accuracy
 —○— U Messunsicherheit / Uncertainty

DAkkS calibration certificate for balances (extract)

- 1 Official document
- 2 Item to be calibrated
- 3 Traceability, see page 208

- 4 Identification/Applicant
- 5 Metrological component
- 6 Uncertainty of measurement, see page 208

- 7 Application accuracy, see page 206
- 8 Minimum weight of sample (additional price)

To get reliable weighing results you need to have calibrated balances. KERN offers you an extensive calibration service for your balances – you have the choice:

Recalibration

- The recalibration schedule depends on the frequency of use, the conditions of use and the safety requirements.
- We would recommend that you recalibrate your balances every 6 months if they are used intensively, and every 12 months with normal use.
- The KERN calibration service is independent of the brand.



B63 - 100
 D-K-
 19408-01-00
 2019-01

Initial calibration and recalibration of balance at the KERN factory	KERN	Price excl. of VAT ex works €
Weighing capacity		
Analytical balances		
[Max] ≤ 5 kg	963-101	138,-
[Max] > 5 kg	963-102	176,-
Precision balances/Industrial scales		
[Max] ≤ 5 kg	963-127	72,-
[Max] > 5 kg – 50 kg	963-128	88,-
[Max] > 50 kg – 350 kg	963-129	105,-
[Max] > 350 kg – 1500 kg	963-130	165,-
[Max] > 1500 kg – 2900 kg ¹⁾	963-131	220,-
[Max] > 2900 kg – 6000 kg ¹⁾	963-132	440,-
[Max] > 6000 kg – 12000 kg ¹⁾	963-133	500,-
Hanging scales/Crane scales		
[Max] ≤ 5 kg	963-127H	72,-
[Max] > 5 kg – 50 kg	963-128H	88,-
[Max] > 50 kg – 350 kg	963-129H	105,-
[Max] > 350 kg – 1500 kg	963-130H	165,-
[Max] > 1500 kg – 2900 kg	963-131H	250,-
[Max] > 2900 kg – 6000 kg	963-132H	500,-
[Max] > 6000 kg – 12000 kg ³⁾	963-133H	700,-
Preparation for recalibration (cleaning, adjustment, function test)	969-003R	20,-
Additional services		
Minimum weight of sample (for details see internet)	969-103	10,-
Additional measurement points (as part of the) weighing test	963-140	5,-/ measurement point
Additional measurement points (as part of the) repeatability testing	963-140	5,-/ each further m.p.
DAkkS Express service with delivery time 48 hours (only on initial purchase, details see p. 202)	962-116	50,-/ scale
Express shipping: Express supplement for guaranteed delivery on the next working day (if ready for shipment before 12:00 noon)	in GER only	40,-/ parcel

1) Floor scales & axle load scales only (Price per weighing panel). Please ask for further details.
 2) On request
 3) Processing time 4 working days
 4) Processing time 15 working days

Minimum weight of sample (in use)

What is the lightest item you can weigh on your balance, while still achieving accurate and reliable weighing results? What exactly is the limit?

The KERN minimum sample weight protocol accounts for the established minimum sample weight of your balance and its location of installation and use with the relative measuring uncertainty. With various safety coefficients and required weighing accuracy (process accuracy), depending on standard or quality-related requirements on the balance being used.

The higher the selected safety coefficient, the higher the safety when using the balance in a particular process. Typical perturbations when using the balance e.g. small fluctuations in temperature are taken into account. In easily predictable conditions in a professional environment of use, KERN recommends a safety coefficient of 3. For critical processes, a correspondingly higher factor should be selected. The minimum sample weight protocol contains a diagram as well as a table, from which you can ascertain the minimum sample weight for your balance, depending on the process.

Adjustment at the location of installation

Why?

Adjustment at the location of installation is necessary, as the measuring results of balances depend on the local gravitational force (gravitational acceleration) and therefore depend on the location of use. KERN can carry this out just before shipping at the factor, individually to suit the location of installation.

What are the advantages of carrying out adjustment at the location of installation?

- The balance gives reliable measurement results at the location of installation.
- No time-consuming on-site adjustment necessary.
- You do not need a Service Engineer or any additional weights.
- The balance is ready for immediate use.

Pricing table for adjustment at the location of installation

Weighing capacity	KERN	Price excl. of VAT ex works €
[Max] ≤ 5 kg	961-247	36,-
[Max] > 5 - 50 kg	961-247	44,-
[Max] > 50 - 350 kg	961-249	52,-
[Max] > 350 - 1500 kg	961-250	83,-
[Max] > 1500 - 2900 kg	961-251	110,-
[Max] > 2900 - 6000 kg	961-252	220,-
[Max] > 6000 - 12000 kg	961-253	250,-

For adjustment to the location of installation you need the value for gravitational acceleration at the location of installation, which KERN can calculate using the point of use. The procedure is suitable for balances with a resolution of <60,000 d. For higher resolutions we recommend a balance with an internal adjusting weight or adjustment with a calibrated adjusting weight at the location of installation.

Certificate of conformity

With a certificate of conformity you get a statement about whether the balance meets your defined requirements.

In conjunction with a DAkkS calibration certificate it serves as documented proof that the balance fulfils the required process demands. When doing this the process owner for the balance can select from different temperature specifications – depending on its individual requirements:

Conformity evaluation on the basis of the:	KERN	Price excl. of VAT ex works €
Usage accuracy*	relative	969-511
	absolute	969-512
Calibration results*	relative	969-513
	absolute	969-514
Measurements as manufacturer or customer specification	Foreign device	969-515
	Customer specifications	969-516
	KERN devices	969-517
		on request 10,-

relative = % / absolute = g

*as attachment to the DAkkS calibration certificate (Details see www.kern-lab.com)

Example for absolute customer tolerance (absolute) (Item no. 969-511):

No.	Tare	Load	Display	Deviation	Uncertainty	Customer tolerance	Conformity ¹⁾
1	0 g	500 g	500,00 g	0,00 g	± 0,013 g	± 0,05 g	<input checked="" type="checkbox"/>
2	0 g	1000 g	1000,00 g	0,00 g	± 0,015 g	± 0,05 g	<input checked="" type="checkbox"/>
3	0 g	1500 g	1500,01 g	0,01 g	± 0,017 g	± 0,05 g	<input checked="" type="checkbox"/>
4	0 g	2000 g	2000,01 g	0,01 g	± 0,020 g	± 0,10 g	<input checked="" type="checkbox"/>
5	0 g	3000 g	3000,02 g	0,02 g	± 0,022 g	± 0,10 g	<input checked="" type="checkbox"/>

1) Evaluation criteria: |[Deviation]| + [extended measuring uncertainty] ≤ [tolerance]

Documented quality of your balances in the log book

Consistently high product quality requires the use of measuring and test equipment that provides comprehensible, consistent and reproducible results. Hence, quality management systems require that measuring and test equipment produces a detailed traceable description and documentation of calibration results and conformity statements. Work not documented is work not done.

Equipment qualification is documentary evidence that a equipment is suitable for the intended purpose and is working faultlessly. A balance log book is used to record all activities and results required for the qualification and monitoring of balances during routine operation. This includes the installation and commissioning of the balances, routine tests, maintenance as well as the recording of special events (failures, repairs, change of location).

The structure of the balance log book is based on the qualification process of the balance. The requirements for the qualification system such as DIN EN ISO 9001, DIN EN ISO/IEC 17025, GLP/GMP, VDA must be taken into account. The log book supports the user in his/her daily work with the balance and is meant to serve as necessary evidence during inspections and audits. The responsibility for maintaining the log book and its appropriate use is to be borne by the user.

Our proposal: Count on our support!

KERN offers this qualification concept throughout. Our validation services are carried out on the spot by technicians of our calibration laboratory and comprise among other things: installation, measurement test inclusive DAkks calibration certificate as well as records in your qualification log book.

We give you advice about the options of device qualification, as required and will be happy to set up an appointment for qualification at the place of installation. We offer individual calibration and maintenance agreements for the periodically required requalification.

Further information can be found at www.kern-lab.com



Installation qualification (IQ)

All steps to be taken for the installation and commissioning of the equipment are described in detail in the installation qualification. These include among others:

- checking for completeness of delivery and assurance that the delivered equipment meets the required specifications
- a description of the ambient conditions at the place of installation
- proper installation and assurance that the equipment is ready for operation after installation
- documentation of equipment configuration and equipment settings
- Recording and installation of connected peripherals units



Function qualification (OQ)

The operational qualification describes the metrological test performed for the balance at the place of installation. In the course of this all parameters that define the efficiency of a measurement will be checked. Functional qualification is carried out with the help of a standard operating procedure (SOP) and recorded in a calibration certificate. The OQ must be carried out by trained staff with the help of qualified aids (such as certified weights that are traceable to an approved standard). Briefing / training of users must be assured and recorded in the OQ.



Performance qualification (PQ)

The PQ represents documented evidence that the balance or weighing system functions in the selected application as intended. This will be assured by a qualification test of the equipment under real conditions with respect to its surroundings and the problem definition (such as traceable data transmission). If the balance or weighing system is "merely" to be used for weighing it will not be necessary to carry out a PQ as the ability to function has already been proven during the metrological test (OQ).



Maintenance qualification (MQ)

The periodical maintenance, cleaning work and complete metrological test of the balance/weighing system is documented in the MQ by a trained authorised engineer. The results are documented on a DAkks calibration certificate. Maintenance is carried out with the help of a maintenance schedule.



If you are interested in a qualification or training for equipment qualification, please feel free to contact us at **+49 7433 9933-196**

KERN & Sohn GmbH
Älteste europäische Feinwaagen und Gewichtefabrik seit 1844
 Oldest European Manufacturer of Precision Balances since 1844

akkreditiert durch die / accredited by the
Deutsche Akkreditierungsstelle GmbH
als Kalibrierlaboratorium im / as calibration laboratory in the
 Deutschen Kalibrierdienst **DAkkS**

Calibration certificate
G1-123
D-K-
 19408-01-00
 2014-05

Kalibrierschein
Calibration certificate

Gegenstand
Object

Hersteller
Manufacturer

Typ
Type

Fabrikate/Serien-Nr.
Serial number

Auftraggeber
Customer

Gewichtssatz, 1 mg - 1 kg
Klasse E2

Set of weights, 1 mg - 1 kg
Class E2

KERN & Sohn GmbH
Ziegelei 1
D-72336 Balingen
Germany

G123456789

Mustermann GmbH
Teststr. 1
42446 Musterstadt
Deutschland

Dieser Kalibrierschein dokumentiert die Rückführung auf nationale Normale zur Darstellung der Einheiten in Übereinstimmung mit dem Internationalen Einheitensystem (SI). Die DAkkS ist Unterzeichner der multilateralen Übereinkommen der European co-operation for Accreditation (EA) und der International Laboratory Accreditation Cooperation (ILAC) zur gegenseitigen Anerkennung der Kalibrierscheine. Für die Einhaltung einer angemessenen Frist zur Wiederholung der Kalibrierung ist der Benutzer verantwortlich.

This calibration certificate documents the traceability to national standards, which realize the units of measurement according to the International System of Units (SI). The DAkkS is signatory to the multilateral agreements of the European co-operation for Accreditation (EA) and of the International Accreditation (EA) and of the International Accreditation (ILAC) for

Auftragsnummer 2014-123456789

Kalibrierverfahren:
Calibration method

Umgebungsbedingungen:
Ambient conditions

Referenzgewichte:
Standard weights

Material / angenommene Dichte:
Material / assumed density

	von <i>from</i>	bis <i>to</i>	Unsicherheit <i>uncertainty</i>
Temperatur (°C) <i>temperature</i>	22,9	24,1	0,1
rel. Luftfeuchte (%) <i>relative humidity</i>	48,5	53,4	2,0
Luftdruck (hPa) <i>air pressure</i>	942,5	948,5	0,3

Nennwert <i>nominal value</i>	Dichte <i>density</i>	Unsicherheit <i>uncertainty</i>	Material <i>material</i>	Form <i>shape</i>
1 mg - 500 mg	7950 kg/m ³	140 kg/m ³	Edelstahl <i>Stainless steel</i>	Draht <i>Wire</i>
1 g - 1 kg	8000 kg/m ³	100 kg/m ³	Edelstahl <i>Stainless steel</i>	Knopf <i>Cylindrical form</i>

Messergebnisse:
Measurement results:

Nennwert <i>nominal value</i>	Kennzeichnung <i>marking</i>	konventioneller Wägewert <i>conventional mass</i>	Unsicherheit <i>k=2 uncertainty</i>	Fehlergrenze <i>max. perm. error</i>	Klasse* <i>class*</i>
1 mg		1 mg + 0.0010 mg	0.0020 mg	± 0.0060 mg	E2 ✓
2 mg		2 mg + 0.0005 mg	0.0020 mg	± 0.0060 mg	E2 ✓
2 mg	*	2 mg + 0.0016 mg	0.0020 mg	± 0.0060 mg	E2 ✓
5 mg		5 mg + 0.0010 mg	0.0020 mg	± 0.0060 mg	E2 ✓
10 mg		10 mg + 0.0009 mg	0.0020 mg	± 0.0080 mg	E2 ✓
20 mg		20 mg - 0.001 mg	0.003 mg	± 0.010 mg	E2 ✓
20 mg	*	20 mg + 0.001 mg	0.003 mg	± 0.010 mg	E2 ✓
50 mg		50 mg + 0.001 mg	0.004 mg	± 0.012 mg	E2 ✓
100 mg		100 mg + 0.001 mg	0.005 mg	± 0.016 mg	E2 ✓
200 mg		200 mg + 0.002 mg	0.006 mg	± 0.020 mg	E2 ✓
200 mg	*	200 mg + 0.003 mg	0.006 mg	± 0.020 mg	E2 ✓
500 mg		500 mg + 0.005 mg	0.006 mg	± 0.025 mg	E2 ✓
1 g		1 g + 0.002 mg	0.010 mg	± 0.030 mg	E2 ✓
2 g		2 g + 0.002 mg	0.013 mg	± 0.040 mg	E2 ✓
2 g	*	2 g + 0.002 mg	0.013 mg	± 0.040 mg	E2 ✓
5 g		5 g + 0.010 mg	0.016 mg	± 0.050 mg	E2 ✓
10 g		10 g - 0.007 mg	0.020 mg	± 0.060 mg	E2 ✓
20 g		20 g + 0.005 mg	0.026 mg	± 0.080 mg	E2 ✓
20 g	*	20 g + 0.015 mg	0.026 mg	± 0.080 mg	E2 ✓
50 g		50 g + 0.02 mg	0.03 mg	± 0.10 mg	E2 ✓
100 g		100 g + 0.01 mg	0.05 mg	± 0.16 mg	E2 ✓
200 g		200 g + 0.05 mg	0.10 mg	± 0.30 mg	E2 ✓
200 g	*	200 g - 0.00 mg	0.10 mg	± 0.30 mg	E2 ✓
500 g		500 g + 0.10 mg	0.26 mg	± 0.80 mg	E2 ✓
1 kg		1 kg + 0.1 mg	0.5 mg	± 1.6 mg	E2 ✓

Traceable KERN test weights –

Calibration of test weights

Calibrated measuring equipment requires calibrated checking equipment. For balances, these are calibrated test weights, also called “standard weights”.

KERN will calibrate your test weights

- In all classes with permissible error limits E1–M3 according to OIML R111:2004 (for tolerance tables, see page 164), in sizes 1 mg to 2500 kg.
- With free nominal value
- Newton (N)
- Independent of design (special designs)

The advantages of using the KERN in-house calibration

You send your test weights to us.

- Excellent price performance ratio
- The quickest processing time
 - DAkkS standard service: 4 working days
 - DAkkS express service: 48 hrs (new weights)
- The most modern calibration methods with robot controlled comparators allow the most accurate calibration results and fastest throughput time
- KERN DAkkS calibration certificates are internationally recognised
- A calibration service which is independent of the brand
- KERN also reconditions existing customer weights (e.g. cleaning or readjustment)
- On request, we can also provide a pick-up and collection service with our parcel service

The advantages of using the KERN on-site calibration

We visit you.

We would be pleased to visit you within Germany and carry out the calibration of your reference standards to OIML classes M1–M3, 10 kg–2500 kg with permissible error limits, using our mobile MACOS system. Minimized downtime of your checking equipment and direct contact with our expert are the major benefits of this service. Price on request.

Recalibration

- The recalibration schedule depends on the frequency of use, the conditions of use and the safety requirements
- In terms of standardisation, no particular recalibration interval is specified
- We would recommend that you recalibrate your test weights every six months if they are used intensively, and every 12 months with normal use
- We would be pleased to monitor your recalibration schedule

DAkkS calibration certificate for test weights (extract)

For more details on our calibration service and other useful information, please see the internet on www.kern-lab.com

- 1 Official document
- 2 Item to be calibrated
- 3 Traceability, see page 208
- 4 Identification/Applicant
- 5 Environmental conditions
- 6 Metrological component
- 7 Conventional mass
- 8 Uncertainty of measurement, see page 208



Recalibration price of test weights (DAkkS calibration)

Class acc. →	E1 with volume determination		E1 without volume determination		E2		F1/F2 * F2 only		M1/M2/M3	
	Nominal value ↓	Price € excl. of VAT ex works	KERN	Price € excl. of VAT ex works	KERN	Price € excl. of VAT ex works	KERN	Price € excl. of VAT ex works	KERN	Price € excl. of VAT ex works
1 mg	-	-	962-251R	52,-	962-351R	26,-	962-451R	18,-	962-651R	15,-
2 mg	-	-	962-252R	52,-	962-352R	26,-	962-452R	18,-	962-652R	15,-
5 mg	-	-	962-253R	52,-	962-353R	26,-	962-453R	18,-	962-653R	15,-
10 mg	-	-	962-254R	52,-	962-354R	26,-	962-454R	18,-	962-654R	15,-
20 mg	-	-	962-255R	52,-	962-355R	26,-	962-455R	18,-	962-655R	15,-
50 mg	-	-	962-256R	52,-	962-356R	26,-	962-456R	18,-	962-656R	15,-
100 mg	-	-	962-257R	52,-	962-357R	26,-	962-457R	18,-	962-657R	15,-
200 mg	-	-	962-258R	52,-	962-358R	26,-	962-458R	18,-	962-658R	15,-
500 mg	-	-	962-259R	52,-	962-359R	26,-	962-459R	18,-	962-659R	15,-
1 g	963-231	193,-	962-231R	52,-	962-331R	26,-	962-431R	18,-	962-631R	15,-
2 g	963-232	193,-	962-232R	52,-	962-332R	26,-	962-432R	18,-	962-632R	15,-
5 g	963-233	193,-	962-233R	52,-	962-333R	26,-	962-433R	18,-	962-633R	15,-
10 g	963-234	193,-	962-234R	52,-	962-334R	26,-	962-434R	18,-	962-634R	15,-
20 g	963-235	193,-	962-235R	52,-	962-335R	26,-	962-435R	18,-	962-635R	15,-
50 g	963-236	193,-	962-236R	52,-	962-336R	26,-	962-436R	18,-	962-636R	15,-
100 g	963-237	193,-	962-237R	52,-	962-337R	33,-	962-437R	20,-	962-637R	16,-
200 g	963-238	193,-	962-238R	52,-	962-338R	33,-	962-438R	20,-	962-638R	16,-
500 g	963-239	193,-	962-239R	52,-	962-339R	33,-	962-439R	20,-	962-639R	16,-
1 kg	963-241	193,-	962-241R	52,-	962-341R	33,-	962-441R	20,-	962-641R	16,-
2 kg	963-242	465,-	962-242R	64,-	962-342R	41,-	962-442R	25,-	962-642R	17,-
5 kg	963-243	465,-	962-243R	64,-	962-343R	41,-	962-443R	25,-	962-643R	17,-
10 kg	963-244	465,-	962-244R	64,-	962-344R	41,-	962-444R	25,-	962-644R	17,-
20 kg	963-245	1160,-	962-245R	590,-	962-345R	52,-	962-445R	28,-	962-645R	22,-
50 kg	963-246	1360,-	962-246R	660,-	962-346R	64,-	962-446R	39,-	962-646R	24,-
100 kg	-	-	-	-	-	-	962-591R*	116,-	962-691R	63,-
200 kg	-	-	-	-	-	-	962-592R*	116,-	962-692R	63,-
500 kg	-	-	-	-	-	-	962-593R*	116,-	962-693R	63,-
1000 kg	-	-	-	-	-	-	-	-	962-694R	136,-
2000 kg	-	-	-	-	-	-	-	-	962-695R	250,-
1 mg-500 mg	-	-	962-250R	350,-	962-350R	190,-	962-450R	100,-	962-650R	63,-
1 mg-50 g	963-201	1070,-	962-201R	560,-	962-301R	315,-	962-401R	167,-	962-601R	106,-
1 mg-100 g	963-202	1170,-	962-202R	580,-	962-302R	340,-	962-402R	178,-	962-602R	112,-
1 mg-200 g	963-203	1350,-	962-203R	630,-	962-303R	385,-	962-403R	199,-	962-603R	125,-
1 mg-500 g	963-204	1440,-	962-204R	660,-	962-304R	410,-	962-404R	210,-	962-604R	131,-
1 mg-1 kg	963-205	1530,-	962-205R	700,-	962-305R	435,-	962-405R	220,-	962-605R	137,-
1 mg-2 kg	963-206	2000,-	962-206R	750,-	962-306R	495,-	962-406R	250,-	962-606R	152,-
1 mg-5 kg	963-207	2450,-	962-207R	770,-	962-307R	530,-	962-407R	265,-	962-607R	160,-
1 mg-10 kg	963-208	2900,-	962-208R	800,-	962-308R	560,-	962-408R	285,-	962-608R	167,-
1 g-50 g	963-215	770,-	962-215R	245,-	962-315R	127,-	962-415R	67,-	962-615R	42,-
1 g-100 g	963-216	860,-	962-216R	270,-	962-316R	150,-	962-416R	77,-	962-616R	49,-
1 g-200 g	963-217	1040,-	962-217R	320,-	962-317R	196,-	962-417R	98,-	962-617R	61,-
1 g-500 g	963-218	1130,-	962-218R	350,-	962-318R	220,-	962-418R	109,-	962-618R	68,-
1 g-1 kg	963-219	1230,-	962-219R	375,-	962-319R	245,-	962-419R	119,-	962-619R	74,-
1 g-2 kg	963-220	1780,-	962-220R	425,-	962-320R	305,-	962-420R	151,-	962-620R	89,-
1 g-5 kg	963-221	2230,-	962-221R	450,-	962-321R	340,-	962-421R	166,-	962-621R	96,-
1 g-10 kg	963-222	2690,-	962-222R	485,-	962-322R	370,-	962-422R	182,-	962-622R	104,-

Additional costs for preparation, overhaul and adjustment before the calibration	KERN	Price excl. of VAT ex works €
Preparation of weights (e.g. cleaning, etc.)		
Single weight	969-001R	3,-
Weight set	969-002R	16,-
Subsequent services are carried out after confirmation		
Continued overhaul of weights (e.g. wet-cleaning, markings, repair, special packaging, adjustment E1 (DAkkS only), E2 ...)	969-005R	T & M basis
Adjustment, per weight only available for weights with adjustment chamber (F1-M3)	969-010R	12,-
Second calibration after adjustment or substitution, per weight		
Class E1	969-210R	40,-
Class E1 incl. volume determination	969-211R	80,-
Class E2	969-310R	14,-
Class F1/F2	969-410R	14,-
Class M1-M3	969-610R	14,-
Testing of magnetic properties according to OIML R 111:2004, per weight	972-000	12,-
Calibration of NON-OIML test weights, additional price per weight	-	8,-

KERN DAkkS Express Service	
DAkkS standard service Class E2-M3	4 working days
DAkkS standard service Class E1, 1 mg-500 mg, and recalibration 1 g-10 kg with a known volume	10 working days
Class E1, ≥ 1 g, incl. volume determination (new weights)	15 working days



DAkkS Express service in 48 hours except for class E1

- Urgent order is received at KERN by 12:00 noon at the latest
- Ready for shipping at KERN within two working days, at 12:00 noon
- Return by standard parcel service or express shipping (Costs and processing time on request)
- Additional cost for DAkkS Express Service, for each KERN test weight KERN KERN 962-115 € 20,-
- For Express shipping, see page 198

KERN	Measuring range	Price excl. of VAT ex works €
Tension		
963-161	≤ 500 N	135,-
963-1610	≤ 500 N	250,-
963-162	≤ 2 kN	165,-
963-1620	≤ 2 kN	250,-
963-163	≤ 5 kN	225,-
963-1630	≤ 5 kN	300,-
Compression		
963-261	≤ 500 N	135,-
963-2610	≤ 500 N	250,-
963-262	≤ 2 kN	165,-
963-2620	≤ 2 kN	250,-
963-263	≤ 5 kN	225,-
963-2630	≤ 5 kN	300,-
Zug- und Druckkraft		
963-361	≤ 500 N	245,-
963-3610	≤ 500 N	340,-
963-362	≤ 2 kN	300,-
963-3620	≤ 2 kN	340,-
963-363	≤ 5 kN	405,-
963-3630	≤ 5 kN	405,-

O = No interface (applies to Sauter devices without an interface and also devices from other manufacturers)
R: Recalibration

KERN KERN & Sohn GmbH
 Akkreditiertes Kalibrierlabor seit 1994.
 Accredited calibration laboratory since 1994.

Ihr Partner für Kalibrierdienstleistungen, Prüfmittelmanagement und Beratung.
 Your partner for calibration services, test equipment management and support.

akkreditiert durch die / accredited by the
Deutsche Akkreditierungsstelle GmbH
 als Kalibrierlaboratorium im / as calibration laboratory in the
Deutschen Kalibrierdienst DKD

Kalibrierschein
 Calibration certificate

Kalibrierzeichen
 Calibration mark

Sample
 D.K.
 19426-01-00
 2017-05

Gegenstand
 Object: Kraftmessgerät
 Kraftmessgerät
 Max 500 N, d = 0,1 N

Hersteller
 Manufacturer: Sauter GmbH
 Ziegelis 1
 72336 Balingen
 Deutschland
 FH 500.

Typ
 Type: ZH11110671

Fabrikat-/Serien-Nr.
 Serial number: Mustermann GmbH

Auftraggeber

Dieser Kalibrierschein dokumentiert die Rückführung auf nationale Normale zur Darstellung der Einheiten in Übereinstimmung mit dem Internationalen Einheitensystem (SI).
 Die DAkKS ist Unterzeichner der multilateralen Übereinkommen der European co-operation for Accreditation (EA) und der International Laboratory Accreditation Cooperation (ILAC) zur gegenseitigen Anerkennung der Kalibrierscheine. Für die Erhaltung einer angemessenen Frist zur Wiederholung der Kalibrierung ist der Benutzer zu informieren.

Messwerte (Zugkraft) / Measurement results (tension force)

Ausrichtung rotation	Ausgangsposition / initial position	0°						120°						240°					
Kraft force		R1	R2	R3	R4	R5	R6	R1	R2	R3	R4	R5	R6	R1	R2	R3	R4	R5	R6
0 N	0,0 N	0,0 N	0,0 N	0,0 N	0,0 N	0,0 N	0,0 N	0,0 N	0,0 N	0,0 N	0,0 N	0,0 N	0,0 N	0,0 N	0,0 N	0,0 N	0,0 N	0,0 N	
100,0 N	-99,8 N	-99,8 N	-99,8 N	-99,8 N	-99,8 N	-99,8 N	-99,8 N	-99,8 N	-99,8 N	-99,8 N	-99,8 N	-99,8 N	-99,8 N	-99,8 N	-99,8 N	-99,8 N	-99,8 N	-99,8 N	
200,0 N	-199,6 N	-199,6 N	-199,6 N	-199,6 N	-199,6 N	-199,6 N	-199,6 N	-199,6 N	-199,6 N	-199,6 N	-199,6 N	-199,6 N	-199,6 N	-199,6 N	-199,6 N	-199,6 N	-199,6 N	-199,6 N	
300,0 N	-299,4 N	-299,4 N	-299,4 N	-299,4 N	-299,4 N	-299,4 N	-299,4 N	-299,4 N	-299,4 N	-299,4 N	-299,4 N	-299,4 N	-299,4 N	-299,4 N	-299,4 N	-299,4 N	-299,4 N	-299,4 N	
400,0 N	-399,2 N	-399,2 N	-399,2 N	-399,2 N	-399,2 N	-399,2 N	-399,2 N	-399,2 N	-399,2 N	-399,2 N	-399,2 N	-399,2 N	-399,2 N	-399,2 N	-399,2 N	-399,2 N	-399,2 N	-399,2 N	
500,0 N	-499,0 N	-499,0 N	-499,0 N	-499,0 N	-499,0 N	-499,0 N	-499,0 N	-499,0 N	-499,0 N	-499,0 N	-499,0 N	-499,0 N	-499,0 N	-499,0 N	-499,0 N	-499,0 N	-499,0 N	-499,0 N	
0 N	0,0 N	0,0 N	0,0 N	0,0 N	0,0 N	0,0 N	0,0 N	0,0 N	0,0 N	0,0 N	0,0 N	0,0 N	0,0 N	0,0 N	0,0 N	0,0 N	0,0 N	0,0 N	

Messergebnisse (Zugkraft) / Measured values (tension force)

Aus den oben aufgeführten Messwerten ergeben sich die folgenden Messergebnisse:
 The following measurement results are calculated using the measured values above:

rel. Kalibrierabweichung 0,000 %
 Rel. Nullpunktabweichungen 0,000 % (R1), 0,000 % (R2), 0,000 % (R3/R4), 0,000 % (R5/R6)

Kraft force	arith. Mittelwert average	rel. Wiederhol- präzision b/ wiederholbarkeit	rel. Vergleichs- präzision b/ reproduzierb.	rel. Umkehrspanne * hysteresis
100,0 N	-99,8 N	0,000 %	0,000 %	0,000 %
200,0 N	-199,6 N	0,000 %	0,000 %	0,000 %
300,0 N	-299,4 N	0,000 %	-0,025 %	-0,017 %
400,0 N	-399,2 N	0,000 %	-0,025 %	-0,015 %
500,0 N	-499,0 N	0,000 %	0,000 %	0,000 %

DAkKS Calibration certificate for force-measuring devices (except). Further details on the internet at www.kern-lab.com

YOUR ADVANTAGES:



Universal use ▶ Calibration possible for a variety of instruments



Quick calibration ▶ Test time is four working days only



Express service ▶ Test time duration 48 hours: additional price € 50,-/instrument (excl. of VAT)



Express shipping ▶ guaranteed delivery on the next working day (only in GER): € 40,-/parcel (excl. of VAT)

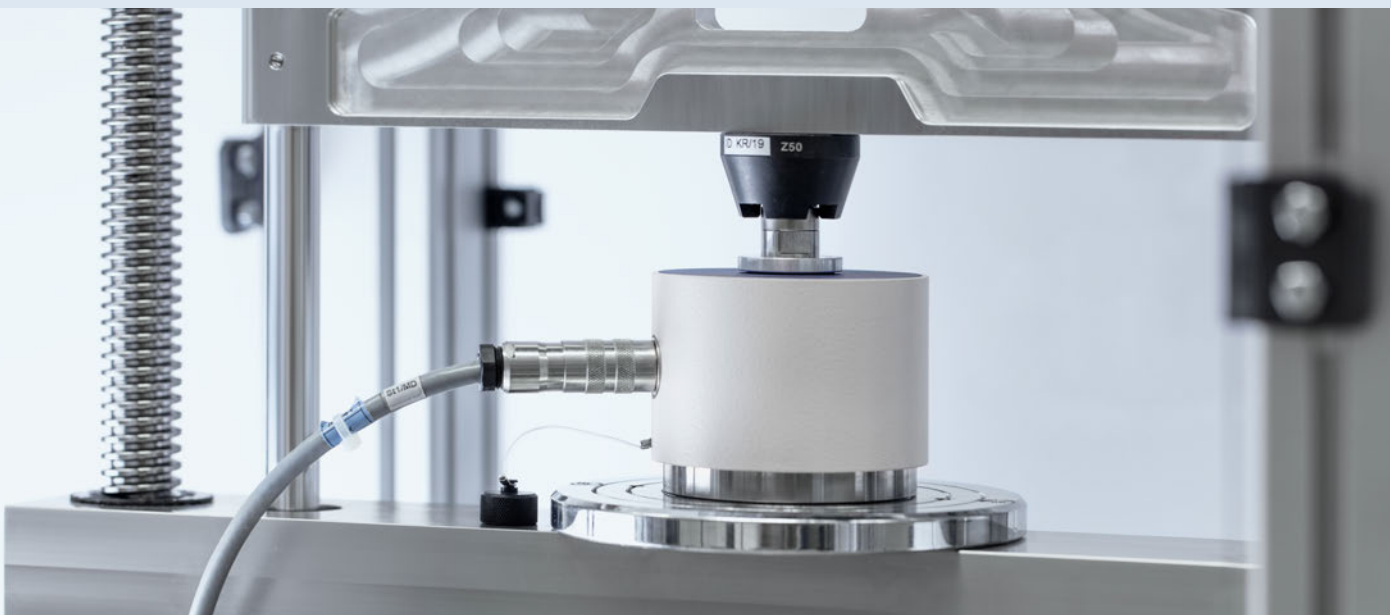

Factory calibration certificates

As DAkkS calibration certificates cannot be offered for all measuring devices or measurement sizes, or where it is not customary, we then offer factory calibration certificates. These calibration certificates meet international standards and are particularly suitable as proof of exacting calibration in the monitoring of your checking equipment, for example:

- Mechanical balances (spring balances, etc.)
- Force-measuring devices up to 120 kN
- Measuring devices for layer thickness 0 µm – 2000 µm
- Hardness testing devices in accordance with Leeb tests
- Ultrasonic material thickness testing device 25 mm - 300 mm

We carry out calibrations independent of brand. In order to avoid any unnecessary delays when processing your order, please send us the technical documents and necessary accessories with the checking device. Calibration time 4 working days.

For up-to-date information on test services for further measuring sizes please visit our website www.kern-lab.com

KERN	Physical unit	Measuring range	Price excl. of VAT ex works €
Factory calibration			
961-161 (O)	Force: Tension	≤ 500 N	135,-
961-162 (O)	Force: Tension	≤ 2 kN	165,-
961-163 (O)	Force: Tension	≤ 10 kN	225,-
961-164	Force: Tension	≤ 20 kN	295,-
961-165	Force: Tension	≤ 50 kN	295,-
961-166	Force: Tension	≤ 100 kN	325,-
961-261 (O)	Force: Compression	50 – 500 N	135,-
961-262 (O)	Force: Compression	≤ 2 kN	165,-
961-263 (O)	Force: Compression	≤ 5 kN	225,-
961-361 (O)	Force: Tens. and Comp.	≤ 500 N	245,-
961-362 (O)	Force: Tens. and Comp.	≤ 2 kN	300,-
961-363 (O)	Force: Tens. and Comp.	≤ 5 kN	405,-
961-167	Force (for digital dynamometer KERN MAP)	≤ 130 kg	120,-
961-110	Coating thickness	≤ 2000 µm F or N	120,-
961-112	Coating thickness	≤ 2000 µm FN	170,-
961-113	Wall thickness (ultra sound)	≤ 300 mm (in stainless steel)	120,-
961-114	Wall thickness (Test blocks)	≤ 300 mm	150,-
961-170	Hardness comparison plate (Shore)	For sets up to 7 plates	95,-
961-131	Hardness tester (Leeb)	400 – 800 HLD	120,-
961-132	Hardness comparison plate (Leeb)	Hardness comparison plate (for Leeb durometer)	120,-
961-270	Hardness (UCI)	200 – 800 HV	260,-
961-150	Length	≤ 300 mm	120,-
961-190	Light	≤ 200000 lx	165,-
961-100	Mass (Mechanical balances/spring balances)	≤ 5 kg	72,-
961-101	Mass (Mechanical balances/spring balances)	> 5 – 50 kg	88,-
961-102	Mass (Mechanical balances/spring balances)	> 50 – 350 kg	105,-
961-103	Mass (Mechanical balances/spring balances)	> 350 – 1500 kg	165,-
961-120	Torque wrench test devices	1 Nm - 200 Nm	170,-
Additional services			
962-116	Express service with 48 hour delivery		50,-/ instrument

O = no interface (applies to Sauter devices without an interface and also devices from other manufacturers)

KERN & Sohn GmbH
 Kalibrationslabor seit 1994.
 Calibration laboratory since 1994.
 Ihr Partner für Kalibrierdienstleistungen, Prüfmittelmanagement und Beratung.
 Your partner for calibration services, test equipment management and support.

Kalibrierschein MS-123-KERN-2016-08
 Calibration certificate

Kalibriergegenstand: Drehmomentschlüssel-Kalibriereinrichtung
 Calibration object: Torque wrench calibration device
 Max. 1 Nm d= 0,0001 Nm

Hersteller: SAUTER GmbH
 Ziegenle 1
 72336 Balingen
 Deutschland

Typ: DB 1-4

Fabrikat/Serien-Nr.: DB1234567

Inventurnummer: -

Auftraggeber: Mustermann GmbH
 Musterle 1
 12345 Musterstadt
 Deutschland

Auftragsnummer: 2016-12345678
 Order No.

Messergebnisse - Rechtsdrehmoment
 Measurement results - clockwise torque

Messung	Referenz-Drehmoment	Anzeige	Abweichung	Messunsicherheit	Toleranz	Konformität
Measurement	Reference torque	Indication	Error	meas. uncertainty	Tolerance	Conformity
1	0,2 Nm	0,1998 Nm	-0,0002 Nm	0,0030 Nm	0,0050 Nm	✓
2	0,6 Nm	0,6004 Nm	+0,0004 Nm	0,0030 Nm	0,0050 Nm	✓
3	1,0 Nm	1,0004 Nm	+0,0004 Nm	0,0030 Nm	0,0050 Nm	✓

Messergebnisse - Linksdrehmoment
 Measurement results - anticlockwise torque

Messung	Referenz-Drehmoment	Anzeige	Abweichung	Messunsicherheit	Toleranz	Konformität
Measurement	Reference torque	Indication	Error	meas. uncertainty	Tolerance	Conformity
1	0,2 Nm	0,2004 Nm	+0,0004 Nm	0,0030 Nm	0,0050 Nm	✓
2	0,6 Nm	0,6002 Nm	-0,0002 Nm	0,0030 Nm	0,0050 Nm	✓
3	1,0 Nm	0,9998 Nm	-0,0002 Nm	0,0030 Nm	0,0050 Nm	✓

1) Es gilt: [Abweichung] = [Anzeige] - [Referenz-Drehmoment] (Gefwert) - [Istwert]
 2) Angegeben ist die erweiterte Messunsicherheit, die sich aus der Standardunsicherheit durch Multiplikation mit dem Erweiterungsfaktor k=2 ergibt. Sie wurde gemäß DAkkS-CKD-3 in Anlehnung an DAkkS-CKD-R 3-8 unter Annahme von für diesen Gerätetyp typischen Werten für die relevanten Kenngrößen bei zweiseitiger Belastung (Richtungsfehler, Wiederhol- und Vergleichspräzision, Drift).

Factory calibration certificate for torque wrench test devices (except from the factory calibration certificate)
 Further details on the internet at www.kern-lab.com

Verification prices for test weights and (crane) scales

Class acc. → OIML R 11:2004	E2 with verification certificate		F1/F2 with verification certificate		M1 with verification certificate	
	Nominal value ↓ KERN	Price excl. of VAT ex works €	KERN	Price excl. of VAT ex works €	KERN	Price excl. of VAT ex works €
1 mg	952-351	40,-	952-451	35,-	952-651	24,-
2 mg	952-352	40,-	952-452	35,-	952-652	24,-
5 mg	952-353	40,-	952-453	35,-	952-653	24,-
10 mg	952-354	40,-	952-454	35,-	952-654	24,-
20 mg	952-355	40,-	952-455	35,-	952-655	24,-
50 mg	952-356	40,-	952-456	35,-	952-656	24,-
100 mg	952-357	40,-	952-457	35,-	952-657	24,-
200 mg	952-358	40,-	952-458	35,-	952-658	24,-
500 mg	952-359	40,-	952-459	35,-	952-659	24,-
1 g	952-331	40,-	952-431	35,-	952-631	24,-
2 g	952-332	40,-	952-432	35,-	952-632	24,-
5 g	952-333	40,-	952-433	35,-	952-633	24,-
10 g	952-334	40,-	952-434	35,-	952-634	24,-
20 g	952-335	40,-	952-435	35,-	952-635	24,-
50 g	952-336	40,-	952-436	35,-	952-636	24,-
100 g	952-337	45,-	952-437	35,-	952-637	24,-
200 g	952-338	45,-	952-438	36,-	952-638	24,-
500 g	952-339	45,-	952-439	36,-	952-639	24,-
1 kg	952-341	45,-	952-441	36,-	952-641	24,-
2 kg	952-342	51,-	952-442	40,-	952-642	25,-
5 kg	952-343	51,-	952-443	40,-	952-643	25,-
10 kg	952-344	51,-	952-444	40,-	952-644	32,-
20 kg	952-345	59,-	952-445	42,-	952-645	36,-
50 kg	952-346	67,-	952-446	50,-	952-646	37,-
1 mg-500 mg	952-350	200,-	952-450	105,-	952-650	66,-
1 mg-50 g	952-301	330,-	952-401	175,-	952-601	111,-
1 mg-100 g	952-302	360,-	952-402	187,-	952-602	117,-
1 mg-200 g	952-303	405,-	952-403	210,-	952-603	131,-
1 mg-500 g	952-304	430,-	952-404	220,-	952-604	137,-
1 mg-1 kg	952-305	455,-	952-405	230,-	952-605	144,-
1 mg-2 kg	952-306	520,-	952-406	260,-	952-606	159,-
1 mg-5 kg	952-307	560,-	952-407	280,-	952-607	168,-
1 mg-10 kg	952-308	590,-	952-408	300,-	952-608	175,-
1 g-50 g	952-315	133,-	952-415	76,-	952-615	50,-
1 g-100 g	952-316	157,-	952-416	81,-	952-616	54,-
1 g-200 g	952-317	205,-	952-417	103,-	952-617	64,-
1 g-500 g	952-318	235,-	952-418	114,-	952-618	71,-
1 g-1 kg	952-319	255,-	952-419	125,-	952-619	78,-
1 g-2 kg	952-320	320,-	952-420	158,-	952-620	93,-
1 g-5 kg	952-321	355,-	952-421	174,-	952-621	101,-
1 g-10 kg	952-322	390,-	952-422	191,-	952-622	109,-

KERN verification delivery time	
Standard verification service Class E2 - M1	6 working days

Additional costs for preparation, overhaul and adjustment before the verification	KERN	Price excl. of VAT ex works €
---	------	-------------------------------

Preparation of weights (e.g. cleaning, etc.)		
Single weight	969-008R	3,-
Weight set	969-009R	16,-

Subsequent services are carried out after confirmation

Continued overhaul of weights (e.g. wet-cleaning, markings, repair, special packaging, adjustment E2 ...)	969-005R	T & M basis
---	----------	-------------

Adjustment, per weight only available for weights with adjustment chamber (F1/F2 - M1)	969-010R	12,-
--	----------	------

Verification after adjustment or substitution, per weight

Class E2	969-310R	14,-
Class F1/F2	969-410R	14,-
Class M1	969-610R	14,-

Verification prices for balances	Initial verification	Price excl. of VAT ex works €	Reverification	Price excl. of VAT ex works €
	KERN	€	KERN	€
Accuracy class I (precision balances) ¹⁾				
[Max] ≤ 5 kg ¹⁾	965-201	110,-	950-101R	180,-
[Max] > 5 kg ¹⁾	965-202	110,-	950-102R	230,-
Accuracy class II (precision balances) ¹⁾				
[Max] ≤ 5 kg ¹⁾	965-216	66,-	950-116R	90,-
[Max] > 5 kg - 50 kg ¹⁾	965-217	77,-	950-117R	110,-
[Max] > 50 kg - 350 kg ¹⁾	965-218	110,-	950-118R	170,-
Accuracy class III-IV ¹⁾				
Bench scales and industrial scales (excl. crane scales)				
[Max] ≤ 5 kg ¹⁾	965-227	55,-	950-127R	86,-
[Max] > 5 kg - 50 kg ¹⁾	965-228	70,-	950-128R	86,-
[Max] > 50 kg - 350 kg ¹⁾	965-229	93,-	950-129R	138,-
[Max] > 350 kg - 1500 kg ¹⁾	965-230	132,-	950-130R	200,-
[Max] > 1500 kg - 2900 kg ¹⁾	965-231	132,-	950-131R	280,-
[Max] > 2900 kg - 6000 kg ¹⁾	965-232	200,-	950-132R	430,-
Crane scales				
[Max] > 50 kg - 350 kg ¹⁾	965-129H	105,-	950-129HR	150,-
[Max] > 350 kg - 1500 kg ¹⁾	965-130H	132,-	950-130HR	250,-
[Max] > 1500 kg - 2900 kg ¹⁾	965-131H	150,-	950-131HR	360,-
[Max] > 2900 kg - 6000 kg ¹⁾	965-132H	200,-	950-132HR	550,-
[Max] > 6000 kg - 12000 kg ¹⁾	965-133H	300,-	950-133HR	870,-

¹⁾ Processing time 4 working days, ²⁾ Processing time 15 working days, ¹⁾²⁾ Preparation of reverification of balances, 969-006R, € 20,-

A**Accuracy classes for test weights**E, F, M ▶ *Error limit classes***Adjusting of measurement equipment**

Precise setting of a measurement value via a professional intervention in the measurement system.

Adjusting the weighing range of a balance

Either with the external test weight via the **adjusting program CAL**, or with the **internal automatic adjustment** resp. **adjusting switch**. It is necessary with variations in temperature, a change of environmental conditions, change of location, etc.

Recommended as a daily check routine.

Alibi memory

For weighings where verification is mandatory, and which are to be analysed and processed by a PC (e.g. printing out a packing list using a PC instead of a printer connected directly to the balance) electronic archiving is required by the metrological authorities by a verifiable data memory which cannot be manipulated. Alibi memories from KERN fulfil this requirement. They are for paperless archiving of weighing results. For KERN products the alibi memory is fitted inside the balance, right between where the weight is determined and the output to the PC.

All data transferred to the PC is stored with date, time and all important weights for at least three months. These stored data strings can be displayed on the balance at any time. The data in the alibi memory can be deleted, but not changed.

Application accuracy

Allowance for measuring uncertainty during practical use of a balance. Is given in the appendix to the DKD calibration certificate.

ATEX

Derived from **AT**mosphère **EX**plosibles. (explosive atmosphere). A synonym for EU guidelines, which controls the quality and use of equipment in hazardous industrial environments, where there is explosion danger, e.g. by handling of flammable substances, which are present in high concentrations in the form of gas, mist, vapour or dust. See also 2014/34/EU as well as 1999/92/EU.

B**Balances which are verified/not approved for verification**

Metrologically almost identical. For verified balances certain details are regulated by law, e.g. software changes and additional markings.

C**CAL**

Adjusting the balance is triggered with an external test weight by using the CAL key on the key pad or on the touch display of the display device or the CAL menu option. This will guarantee the consistent high accuracy of the balance.

Calibration of measurement equipment

Determination of the precision of a measurement value without intervention in the measurement system. Example: to check a balance you load a ▶ **test weight** upon it. The term "Calibrating" was formerly also used for ▶ **Adjusting**.

Calibration Certificate DKD/DAkkS

See product group 18 "Calibration service"

Calibration or verification

DAkkS-Calibration is possible for every balance in perfect condition. DAkkS calibration (DKD) is a private service monitored by the state for ensuring high quality requirements according to ISO 9000ff and others, e.g. in production or research. **Verifying (conformity assessment)** is only possible for type-approved balances marked with the green **M** ▶ **Verification**

Commercial error limit

Permitted tolerance (plus and minus) of measuring devices where verification is mandatory when used within their verification validity period. This tolerance is double the permissible error limit, in so far as this is not specified otherwise in the Weights and Measures Act).

Conformity assessment

Procedure for confirming warranted characteristics in accordance with recognised rules. For balances this relates to verification.

Conformity declaration from the manufacturer

The manufacturer declares that the product fulfils the applicable EU directives. With electronic balances this is always in conjunction with the CE mark.

Control of measuring equipment in the QM system in conjunction with quality standards

An organisation certified to a quality standard such as DIN EN ISO 9001 ff. e.g. a production plant is obliged to adhere to a defined quality standard within the framework of its quality management system. To do this, it is imperative to have a measurement equipment which is working accurately. Chapter 7.1.5 "Resources for monitoring and measuring" of DIN EN ISO 9001:2015-11 states that measuring equipment must be calibrated at defined intervals and before use. The measurement devices and measurement standards needed to do this must:

- be traced back to international or national standards.
(▶ **Traceability to the National Standard**)
 - their uncertainty of measurement must be known- they must be marked with a clear identification
 - the test must be documented
- The ▶ **DAkkS calibration (DKD)** fulfils all these requirements.

Conventional mass of weights

The problem is the air movement, which makes the weight appear lighter. In order to avoid this "distortion" in daily use, all weights are adjusted to the unit specifications given in R111, e.g. it is accepted that: material density of the weights is 8000 kg/m³, air density is 1.2 kg/m³ and measuring temperature is 20°C.

Counting resolution

The counting resolution is calculated in points from the ratio of the weighing range [Max] divided by the smallest part weight. It is a statement of counting accuracy.

D**DAkkS = German accreditation authority**

▶ **Calibration Certificate DKD/DAkkS**

See product group 18 "Calibration service"

Data interface

To connect the balance to a printer, PC, network or a second balance. Typical interfaces are, for example, RS-232, RS-485, USB, Bluetooth, LAN, Digital I/O, DUAL, LAN etc. The interface parameters can be set using the balance. The interfaces available are stated in the model description.

Density determination

One of the main areas of application for laboratory balances is determining densities, e.g. determining the specific weight of liquids and solids. To do this you will need a highly accurate precision balance and a density set. It is particularly convenient if the balance can calculate and display the density right away. It has become apparent that by means of weighing when in the process of determining the density of liquids and solids according to the buoyancy method particularly accurate results can be obtained (Archimedes' principle).

- a) Density determination of liquids: By means of measuring the buoyancy with a glass plummet with known volume immersed in the liquid to be measured
- b) Density determination of solid bodies: The density is the ratio of weight [g] : Volume [cm³]. The weight is derived by weighing the sample in air. The volume is determined from the buoyancy $A = \text{weight loss in [g] of a sample, which is submerged in a liquid. The density } D [\text{g/cm}^3] \text{ of this liquid must be known. The volume [cm}^3] \text{ is a result of } A : D.$

Glossary

Applications:

- Pre-packaged goods control, whenever a product is sold according to its volume [cm³]. This volume is calculated with weight [g] : density [g/cm³].
- Materials analysis
- Density of porous materials

DMS = Strain gauge



An electrical resistor strip that is glued to an elastic deforming body made of aluminium. As the strain gauge is mechanically deformed its resistance value changes, allowing the measured value to be calculated.

Draught shield

Required for balances with ► **Readout** $d \leq 1$ mg, to avoid disturbing air movements.

Dual-range balance

As the load increases, the balance switches automatically to the next largest range, for both, weighing range [Max] as well as readout [d].

E

Error limit classes for test weights according to EU directive OIML R111

For further details, see product group 17 "Test weights"

F

FACTORY

These options can only be carried out at KERN factory.

FORCE = Electromagnetic force compensation



A counterforce is created by means of a coil in a permanent magnet. This counterforce is the same as the load of the weight being measured on the scale and therefore equalising. The measured value is calculated via the change in the coil current.

G

GLP = Good Laboratory Practice

► **ISO/GLP**

Gravitational acceleration

► **Gravitational force**

Gravitational force

very important influence for precise electronic balances. Due to the varying influence balances have to be ► **adjusted at the location of use.**

H

HACCP

= **Hazard Analysis and Critical Control Points (HACCP)** The HACCP concept is a preventative system, which is designed to guarantee the safety of foodstuffs EC regulation 852/2004 mandates the use of the HACCP concept for all companies which are involved in production, processing and sales of foodstuffs.

I

ISO 9000ff/DIN EN ISO 9000ff

Quality Management System in the form of a DIN Norm for quality assurance in a factory.

ISO calibration/ISO certificate = factory calibration certificate

Testing measurement devices for accuracy in accordance with a procedure which is recognised, but not accredited.

ISO/GLP record keeping



Quality Assurance Systems demands record keeping of weighing results and correct adjusting of the balance, giving details of date, time and balance identification. The easiest way to obtain this documentation is by means of a connected printer.

J

Junction Box

For connection and simple corner adjustment of several load cells.

L

Linearity/Precision

Greatest deviation of the weight displayed of a balance with regard to the value of the respective test weight in terms of plus and minus across the whole weighing range.

M

Minimum load [Min]

Lower limit of the verifiable weighing range. Is marked on the verification mark. The function of the balance is also given below the minimum load.

Minimum sample weight

Indicates the smallest weight which can be determined, depending on the process accuracy required.

N

Newton

Newton (N) is the unit for physical force values. A Newton is the force required to accelerate a 1 kg mass at rest to a speed of 1 m/s within one second.

Notified body

Neutral and independent, predominantly government bodies, which are formally appointed by the EC. They are engaged in the field of verification for conformity evaluations (initial verification) and type-approval test within the scope of type approvals.

O

Optimisation of reference weight (when piece counting)

See product group 10 "Counting balances/Counting systems".

P

Percentage determination



Example: Reference weight prior to drying: 50g = balance display 100%. After drying 40g = balance display 80% absolute (dry mass) or 20% relative (humidity).

Permissible ambient temperature

Measuring errors are possible if you use the balances outside the permitted specified ambient temperature range. With verified balances this is stated on the identification plate.

PLU (Price Look Up)

This refers to a data memory in price-computing retail scales for the base price of sales items.

Pre-packaging legislation (FPVO)

Ensures that pre-packed goods are filled correctly, for example, in food industry. The Weights and Measures Act governs the permissible weight and volume tolerances.

PRE-TARE

Entering and saving a tare weight (e.g. container weight) through weighing or manual entry using the balance keypad before the actual weighing process. When you subsequently place the tare container on the balance, the balance will show zero immediately – saves time. Particularly useful e.g. for checking fill levels

Proof of compatibility

This documents the verification compatibility for combinations of weighing modules such as display devices, load cells and connecting elements.

R

Readout [d]

Smallest readable weight increment on a digital display.

Recalibration

Periodic checking of the precision of measurement equipment/checking equipment (e.g. balances/weights) to control accuracy, ► **Control of measurement equipment**

Reference weight (when piece counting)

See product group 08 "Counting balances/Counting systems".

Reproducibility (standard deviation)

Sequenced measure of conformity in repeated weighing (e.g. balances) subject to the same conditions. Mostly 1 [d] or less. Quality feature.

Resolution of a balance

The resolution is calculated from the weighing range [Max] divided by the readout [d], e. g. [Max] 420 g : [d] 0.001 g = 420,000 points. The resolution is a quality feature – the higher, the better.

S**SC-TECH = Single-Cell-Technology**

► **FORCE**. The load cell consists of a single aluminium block, which gives a very high measurement quality.

Semi-micro balance

Analytical balance with a readout [d] = 0,01 mg

Smallest part weight when counting

The smallest piece weight, which a balance can accept for piece counting. For the relevant model, enter “g/piece” in the product data table.

T**T-FORK = Tuning fork principle**

A resonating body (like a tuning fork) is electromagnetically excited, causing it to oscillate. The measured value is calculated via the change in frequency corresponding to the load of the weight being measured on the scale.

Taring, automatic

► **PRE-TARE**

Taring, subtractive

The available weighing range of a balance is reduced by the value of the tare load.

Example: weighing range of a balance Max 6000g, Tare (= container) 470g, available weighing range 5530g.

Test weight, external (previously calibration weight)

For adjusting or checking the balance accuracy ► **Adjusting the weighing range**. The external test weight can be DAkkS calibrated at any time, even afterwards, see product group 18 “Calibration Service”.

Test weight, internal

Like test weight external, but installed in the balance and powered.

Totalising

Various individual weighings are added automatically to aggregate, e.g. all individual weighings of a batch.

Traceability to the National Standard

A pre-requisite for every perfect measurement is the validated comprehensive proof that the measuring equipment can be traced back to the international or national standards. In Germany the statutory binding standards are available from the PTB.

Type approval for balances

Strict process to test whether a balance fulfils the verification requirements. A balance can only be verified, if it has got a type approval from a ► **notified body**.

U**Uncertainty of measurement of a balance (= standard deviation)**

Determined for each balance according to a precisely given test method and documented in the ► **Calibration certificate**. It depends on various factors, both, internal and external. Uncertainty of measurement increases by a rising charge of the balance, see product group 18 “Calibration Service”

V**Verification**

Verification, in accordance with the new terminology “Conformity assessment”. Only balances with ► **EC type approval** can be evaluated for conformity. These balances have an identification plate with the metrology marking **M**. The state requires assessment for conformity and this assessment serves as consumer protection. According to EU directive 2014/31/EEC balances must be officially assessed for conformity (calibrated) if they are used as follows:

- in commercial trade when the price of a commodity is determined by weighing.
- in the manufacture of pharmaceuticals in pharmacies and analysis in pharmaceutical and medical laboratories.
- for official purposes.
- in the production of prepackaging.
- in medical applications.

Every balance is tested by KERN and marked with a conformity mark. Its accuracy within the framework of permissible tolerances is thereby confirmed. EU verification applies to all member states of the EU.

Verification classes of balances

Class I – Analytical balance (precision balance), Class II – precision balance, Class III – industrial scale (commercial scale).

Verification of a balance with adjusting program CAL EXT

The adjusting program is sealed with an official mark after the verification. Thus the verification is only valid for the specific location of use. ► **Gravitational force**
To be able to correctly adjust the balance to your location of use, it is necessary to advise the location of use and postcode. See individual model details for the information as to whether verification can be carried out in the factory or at the location of use.

Verification of a balance with automatic internal adjusting CAL INT

The above restrictions in respect of the location of use do not apply, because the automatic internal adjusting works also after verification, therefore it is not sealed. In this case, verification does not depend on the location.

Verification validity for balances

Generally 2 years for all verification classes, for control balances generally 1 year, after expiry the balance has to be re-verified.

Verification value [e]

Measure of the verification tolerance, depending on balance, mostly between 1 [d] and 10 [d] ► **Readout**

W**Weighing range [Max]**

is the working range of the balance. The balance can be loaded up to the specified upper limit.

Sales conditions



All prices are valid as of January 1st 2019 until a new version of the KERN catalogue is released. In Europe, all prices do not include the applicable V.A.T.

At KERN there is no minimum order value. For orders less than € 15.00 there is no re-sale discount available.

Delivery Conditions: we supply ex works Balingen, e.g. the transport costs are invoiced. With our contract logistics partners we always offer you shipping at a good rate. When shipping to islands or other more distant areas, or areas which are difficult to access, the transport costs may possibly be higher, please ask for details. Any goods supplied remain KERN's property until complete payment for the goods sold has been received.



Delivery is usually via courier service.



When you see this symbol by truck, please ask for prices.

Extract from general terms and conditions:

Court of jurisdiction/Legal domicile: 72336 Balingen, Germany;
Commercial register N°: HRB 400865, AG Stuttgart;
Managing director: Albert Sauter

For the full Terms and Conditions, please refer to the website.
www.kern-sohn.com/en/kern/agbs.html

Price changes and product changes are likely in individual cases, due to product modifications as well as error.

Sale or return: within 14 days of purchase. Not valid for order-specific adaptations such as special productions, cable extensions, special weights, etc. or test services such as calibration, verification, etc. Depending on the time and effort involved, there may be processing and storage costs, please ask for details.

Warranty:

- 3 years for products with list price \geq € 400.00
 - 2 years for components as well as products with list price $<$ € 400.00
 - 1 year for pallet truck scales
- Does not apply to consumables such as batteries, rechargeable battery packs, etc.

Balances in areas regulated by law (► Verification) must comply with the commercial error limits during the period of validity for verification – these are usually double the verification permissible error limits. If this period of validity for verification expires, then reverification must be carried out. If, in order to pass the verification, it should be necessary to adjust the balance to comply with the verification permissible error limits, then this does not constitute a warranty claim.

Service



KERN DirectCash: The quick, secure COD procedure for protection against non-payment. With the KERN DirectCash COD system, you can safely deliver orders to end customers with unknown credit rating, with no risk of non-payment. Please request further details on this procedure.

Hire Purchase

Financing is available using KERN hire purchase – easy and convenient. Hire Purchase gives you the option of purchasing any product from our range against a simple monthly installment. The product value is financed over the period of the agreement. On payment of the last installment, the ownership of the contract item automatically transfers from the

contractor to the contractee. The Hire Purchase Agreement can – if you so choose – be set for a period of between one and five years. This package includes the transfer of items as well as the guarantee for the entire transfer period.

Compared with buying the product, KERN hire purchase offers the advantage that the initial financial investment is largely unnecessary. This is particularly relevant when purchasing a number of products, for example when refitting a laboratory, a company department or a hospital ward. In addition the monthly installments constitute a direct cost and the item does not have to be capitalised by the purchaser.

After-Sales-Service



Repair service within 1 week at our plant in Balingen, transportation costs are additional. In urgent cases, if requested by customer, a replacement device will be provided until all repairs are completed; please ask.

Price reduction for a new device: if repair costs exceed the current value of the defective device, a new device will be offered for a discount price. This offer is valid only up to 2 years after warranty expiration.

Spare parts service within 48 hours, transportation costs are additional.

Marketing support



KERN catalogues, brochures, branch prospectuses – your own personalised marketing tools

This catalogue and branch prospectuses are available free of charge. A neutral version of the catalogue, without the KERN address imprint, is also available free of charge for your marketing activities, larger quantities on request.

On demand, your company logo and address can be printed on the back of the KERN catalogue free of charge, larger quantities on request. In this way you have got your own individual marketing tool.

The KERN catalogue and branch prospectuses are available in the following languages: DE, GB, FR, IT, ES.

For further details, see page 211.

Important notice



Explosion hazard or humidity

Our balances are not suitable for rooms with a risk of explosion. Our models are also not suitable for rooms with a high level of air humidity (condensing). Please observe the applicable electrical regulations.

Earth's gravitational force

Electronic balances are subject to location regulations due to the earth's gravitational force. If location of use is changed, reverification and recalibration of the electronic balance is needed.

See the glossary, page 206 ► **Adjusting**

Keyword index

- A**
Accessories _____ 10, 11, 15, 16, 114, _____ 134-143, 160-169
A/D converter box _____ 9, 10
Adiposity scales _____ see website
Adjustment to the location of installation _____ 199
Alibi memory _____ 66, 110, 206
Aluminium sample plate _____ 54-56
Analytical balances _____ 44-51
Animal scales _____ 31-33, 35, 37, 41, _____ 47, 51, 61, 62, 63, 65, 67, 79, _____ 98-112, 118-133, 136-138, 151, 153
- B**
Baby scales _____ see website
Bathroom scales _____ see website
Bench scales _____ 57-69
Bluetooth/RS-232 Adapter _____ 165
Body fat scales _____ see website
- C**
Calibration _____ 194
Calibration Service _____ 194
Carat balances _____ 21, 29, 45
Case, for transport _____ 160
Catalogues, Brochures, Flyer _____ 209, 211
Certificate of conformity _____ 199
Certification DAkkS/DKD _____ 194
Chair scales _____ see website
Chair weighers _____ see website
Coating thickness gauges _____ see website
Control of checking equipment _____ 194
Counting scales _____ 84-93
Counting systems _____ 92
Crane scales _____ 153-159
- D**
DAkkS/DKD _____ 194, 206
Density determination _____ 28, 29, 32, 33, _____ 35, 37, 38, 40, 41, 42, 46, 48, _____ 49, 50, 63, 65, 66, 106, 110, 167, 206
Display devices _____ 134-138
Display, large _____ 166
Drive-through scale _____ 132, 133
Drying balance _____ 54-56
Dust brush _____ 190
- E**
Earth's gravitational force _____ 199, 207, 209
Ethernet/RS-232 Adapter _____ 164
Explosion hazard _____ 209
- F**
Floor scales _____ 115-133
Foot switch _____ 31, 79, 109, 123, 126, 138
Force gauges _____ see website
- G**
Grain balances _____ see website
Gloves _____ 190
- H**
Hand grip dynamometer _____ see website
Handrail scales _____ see website
Hanging scales _____ 148-159
Hardness tester _____ see website
Height rods _____ see website
Hire purchase _____ 209
History KERN _____ 212 (back cover)
Hydrostatic balances _____ 28, 29, 32, 33, 35, 37, _____ 38, 40-42, 46, 48-50, 63, 65, 66, 106, 110
- I**
Industrial scales _____ 57-159
Information _____ 2-7, 206-209
Interface cable _____ 163
Internet _____ 2, 26, 211
Ioniser _____ 168
IP 65...68 protected scales _____ 72-75, 77, 78, 79, _____ 104, 106, 108-113, 117, 118, 120, _____ 122-124, 125, 127-133, 145-147
ISO calibration _____ 194
- L**
Laboratory balances _____ 22-56
Length measuring devices _____ see website
Lexicon _____ 206-208
Load cells _____ 114
Luggage scale _____ 150, 151
- M**
Material thickness gauge _____ see website
Mechanical balances
(spring balances) _____ see website
Medical scales _____ see website
Microscopes, biological _____ see website
Microscopes, metalurgical _____ see website
Microscopes, polarisation _____ see website
Microscopes, stereo _____ see website
Minimum sample weight _____ 198, 199
Mobile pallet weigher _____ 144-147
Moisture analysers _____ 53-56
- P**
Pallet scales _____ 128-131
Personal floor scales _____ see website
Personal scales _____ 123
Pictogram overview _____ 2
Platform scales _____ 94-114
Plattforms _____ 140-143
Pocket balances _____ 20, 21
Power supply adapter set _____ 166
Pre-packaging legislation _____ 206
Precision balances _____ 22-43
Price computing scales _____ 80-83
Printer _____ 161-162
Protective dust cover _____ 167
- R**
Recalibration _____ 194
Refractometers, analogue _____ see website
Refractometers, digital _____ see website
Retail scales _____ 80-83
Roller conveyor _____ 169
Round fiberglass filter _____ 54-56
RS-232/Bluetooth-Adapter _____ 165
RS-232/Ethernet-Adapter _____ 164
RS-232/USB-Adapter _____ 166
RS-232/WLAN-Adapter _____ 164
- S**
Semi-micro balances _____ 46, 49, 50
Shop scales _____ 80-83
Signal lamp _____ 166
Software _____ 12-14
Spring balances _____ see website
Stainless steel scales _____ 72-74, 76-79
Stands _____ 167
- T**
Tablet _____ 15, 16, 139
Tare pan _____ 39, 40, 45, 167
Temperature calibration set _____ 54-56
Tensile force measurement _____ 143, 154, 155, see website
Terms and conditions _____ 209
Terminals _____ 15, 16, 136-139
Test service _____ 194
Test stands _____ see website
Test weights _____ 170-193
Touchscreen scales _____ 15, 16, 66-69, _____ 110-113, 139
Transport case _____ 75
Tweezers _____ 190
- U**
Underfloor weighing, accessories _____ 28, 29, 32, 33, 35, 37, 38, 40-42, 49, 50, 63, 65, 66, 106, 110
USB/RS-232-Adapter _____ 166
- V**
Verification _____ 194
- W**
Warranty _____ 209
Weighing beams _____ 127, 142
Weighing bridges _____ 140-143
Weighing table _____ 168
Weight containers _____ 193
Weight grips _____ 190
Wheelchair platform scales _____ see website
WLAN/RS-232 Adapter _____ 164