

# CPM-10 Economical Multifunction Power Meter

## Operation manual



# CPM-10 Economical Multifunction Power Meter

## DESCRIPTION

CPM-10 Multifunction meter product single phase, three phases high accuracy measurement of parameters such as voltage, current, active power, reactive power, apparent power, power factor, frequency, effective energy, with display and remote communication function. Option 1 set relay output, 1 analogue and 1 RS485 (Modbus RTU Mode) or 1 pulse output. Most suitable for power management, remote input/output, alarm and remote signal control uses needs. Having case depth 120mm only, easy panel mounting installation.



## FEATURE

Input 1P2W, 1P3W, 3P3W, 3P4W Unbalanced or balanced load system's active power, reactive power, apparent power and electric energy (Watts-Hr) etc parameters.  
 Dual display, upper row 4 digits for voltage/ 4 digits for current ( or 10 digits Watts-Hr), lower row 4 1/2 digits Watts.  
 1 set relay(SPDT) output, with 3 variable setting (R1.1/R1.2/R1.3), each react to setting parameters V.AVG/I.AVG/FREQ/P.TL/Q.TL/ S.TL / PF.AVG / AE.TL / RE.TL / VA / VB / VC / IA / IB / IC / PF-A / PF-B / PF-C / P-A / P-B / P-C / Q-A / Q-B / Q-C / S-A / S-B / S-C, having relay function : Hi / Lo / Hi Hold / Lo Hold / Do / OFF; further advance function , start delay, hysteresis, time delay, reset delay etc  
 1 analogues output same as relay setting parameters.  
 Output range: Current 0~10mA / 0~20 mA / 4~20 mA / 4~±20 mA / ±10 mA / ±20 mA (Default 4-20mA)  
 Output range: Voltage 0~5V / 1~5 V / 0~10 V / 0~±5 V / 1~±5 V / 0~±10 V / ±5 V / ±10 V (Default 0-10V)  
 Option pulse and RS 485 communication output.

## Application

Motor control/ panel power monitoring/power consumption monitor and control/power distribution system /intelligent building & automation power management system/ power testing equipment

The CPM-10 system (SCADA) monitoring as a power front-end measurement unit, for volume measurement and control of remote power. Industry-standard RS-485 communication interface and MODBUS protocol, making connecting to the network easily convenient, want to choose the management of the SCADA system. °

## Front panel and button

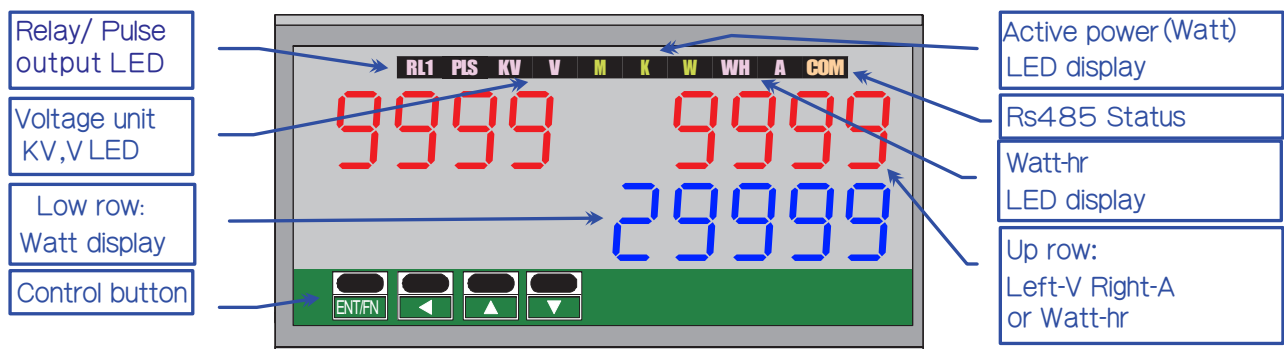

## Dimension

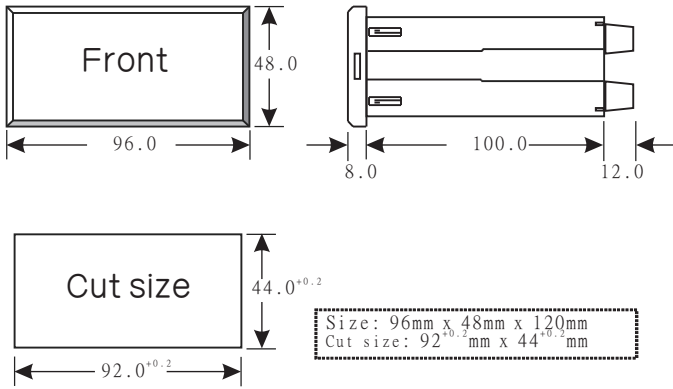

Unit: mm

## Installation

This meter is installed does not exceed the maximum operating temperature and humidity environment.

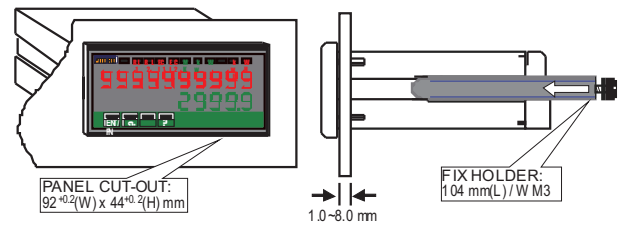

## Operation button

4 Control button Enter / Shift / Up / Down

- Enter/Fun key: Enter setting/save changes and enter next parameters
- Shift key: Change decimal/back to previous or escape setting
- Up key: Increase / back to previous
- Down key: Decrease / to next

## LED Unit

- Voltage unit LED: 2 rectangular red LED indicate KV or V, on when display select V-A
- Watt unit LED: 3 Rectangular green LED, on when display select KWH, automatic switch KW or MW units
- Watt-hr LED: 1 rectangular red LED, on when select KWH display, only display WH, K/M unit follow Watt.
- Current unit LED: 1 rectangular red LED, on when select display V-A

## Display digits

PV values: 5 digits; 0.28" (0.71cm) red LED  
Accumulative values 10 digits; 0.28" (0.71cm)

## LED status

- PLS Pulse output: 1 rectangular red LED, when pulse output LED blink; blink faster mean more watt-hr used.
- RS 485 Com.: 1 rectangular orange LED, when Rs485 send/receive data, LED blink' blink faster mean data transfer
- Relay: 1 rectangular red LED, LED light when relay energized ECI input

## Output wiring

Please check if the voltage is correct and connect to the right terminal number when wiring

**With CLAMP CT, the secondary side do not ground, otherwise the meter burned**

### 1Phase 2 wire

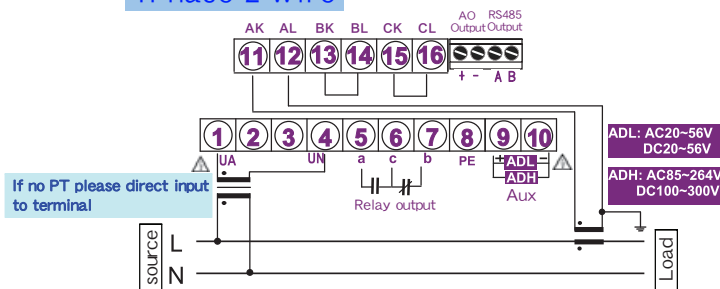

### 3Phase 3wire 2CT (Unbalanced)

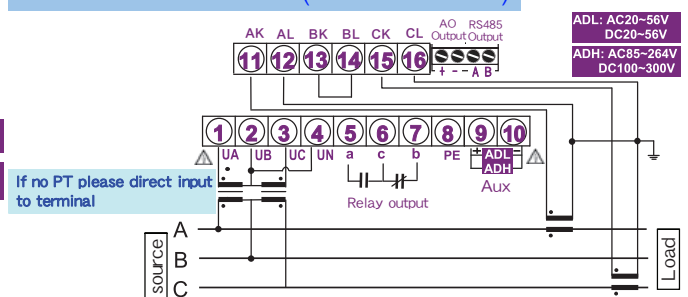

### 1Phase 3 wire

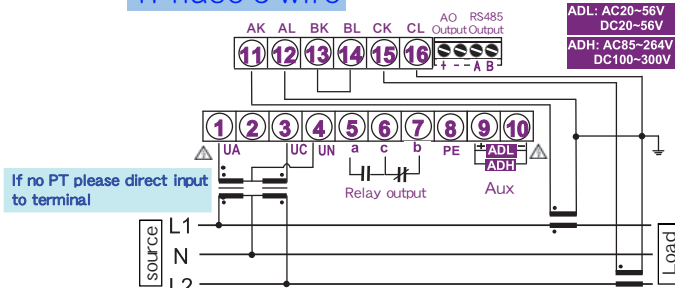

### 3Phase 3wire 3CT (Unbalanced)

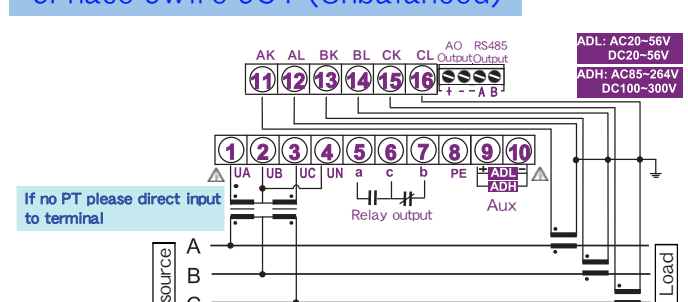

**With CLAMP CT, the secondary side do not ground, otherwise the meter burned**

## Output wiring

When wiring, be sure to confirm that the supply voltage is correct and access the correct terminal number.

Equipment and instrumentation safety, it is recommended to install the fuse or no fuse switch in the instrument before. **With CLAMP CT, the secondary side do not ground, otherwise the meter burned**

### 3Phase 3wire 1CT (Balanced)

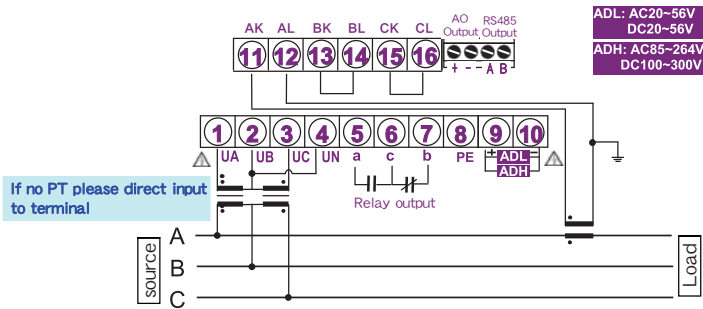

### 3Phase 4wire 3CT (Unbalanced)

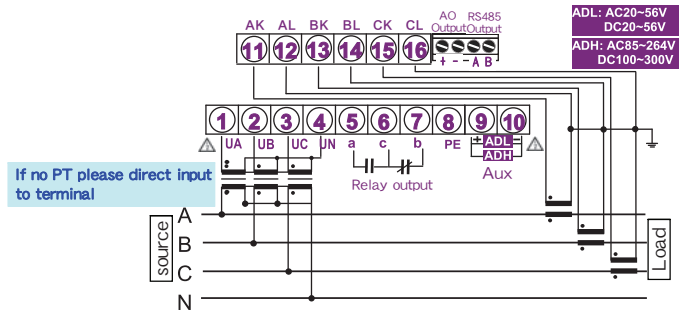

### 3Phase 4wire 1CT (Balanced)

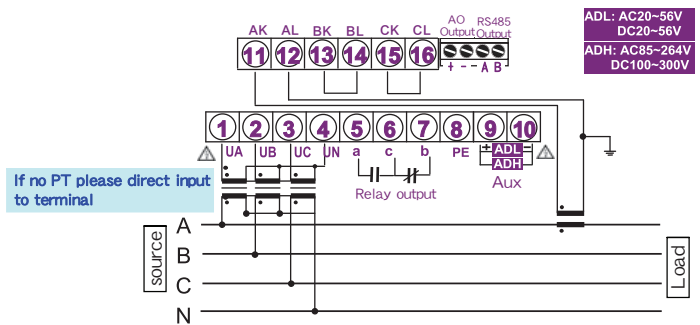

**Example**  
With CLAMP CT, the secondary side do not ground, otherwise the meter burned

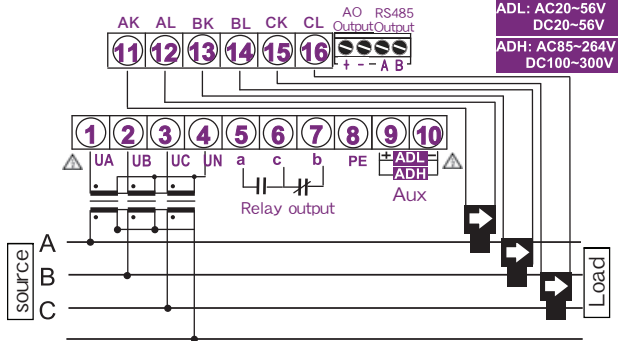

## Clamp CT

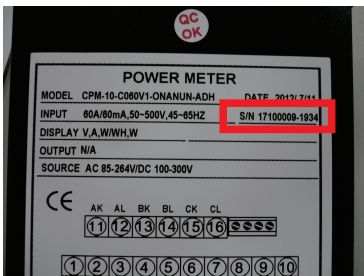

Optional of Clamp CT, make sure

- (1) CT of the SN number with the CPM-10 SN number, as shown
- (2) On the label A:A-Phase; B:B-Phase ; C:C-Phase ; According to the phase matching
- (3) S1 (white) connected "K" side; S2 (black) connected "L" side (A.B.C Phase are the same then the law)

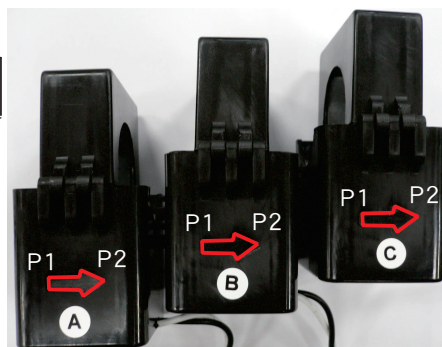

Direction of the arrow indicates the direction for the primary current through P1-P2

## Analogue output

### Wire terminal

Terminal: A1~A16: 20A/600Vac, M3.5, 22~12AWG;  
Max Torque: 13Kg-cm



Output Terminal: 10A 300Vac, M2.6, 22~16AWG,  
Max Torque: 5Kg-cm  
Please use flat Pin

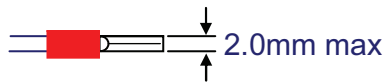

### AUX

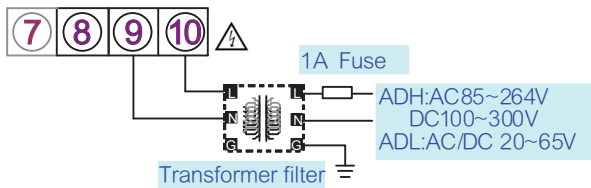

## Analogue output

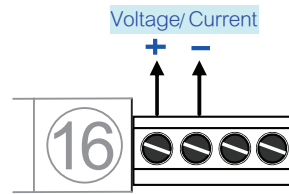

Output mode: Selectable within parameters setting, voltage or current output need to short J2 & J3 on output PCB module.

## Analogue output

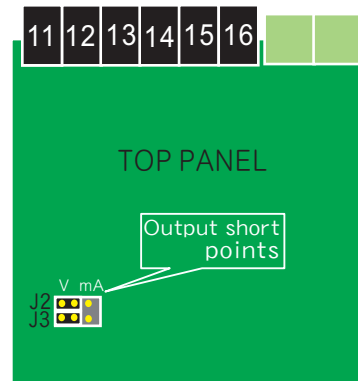

J2 J3 : Current  
J2 J3 : Voltage

## Pulse output

Due to limitation on number of terminal, pulse and relay output is having same terminal, choose either one

Open collector:(OPC1)

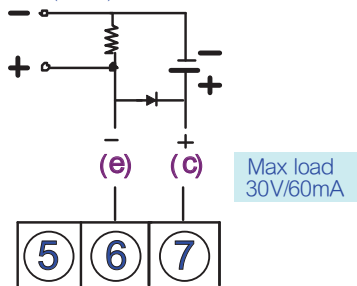

Relay Pulse output :(OPR1)

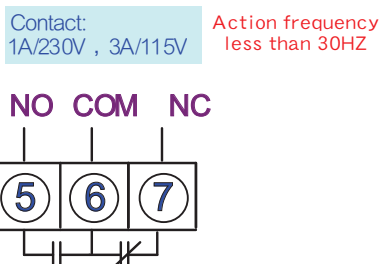

## Analogue + RS485

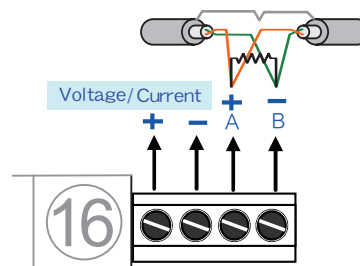

## Alarm Relay output:(OR1)

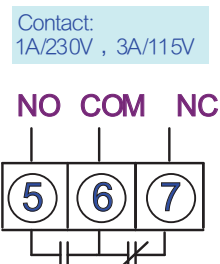

## RS485 Com.

⚠ Please earth isolation net to maintain signal quality

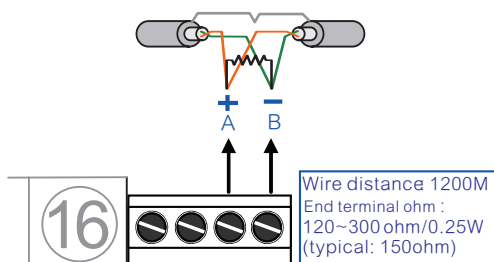

# Operation flow chart:

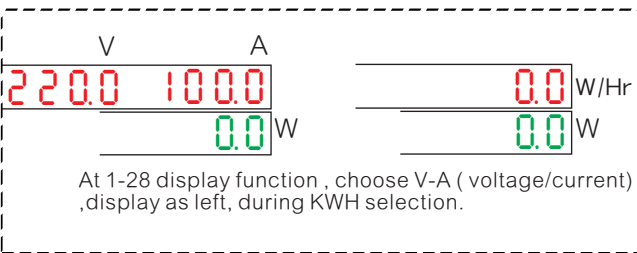
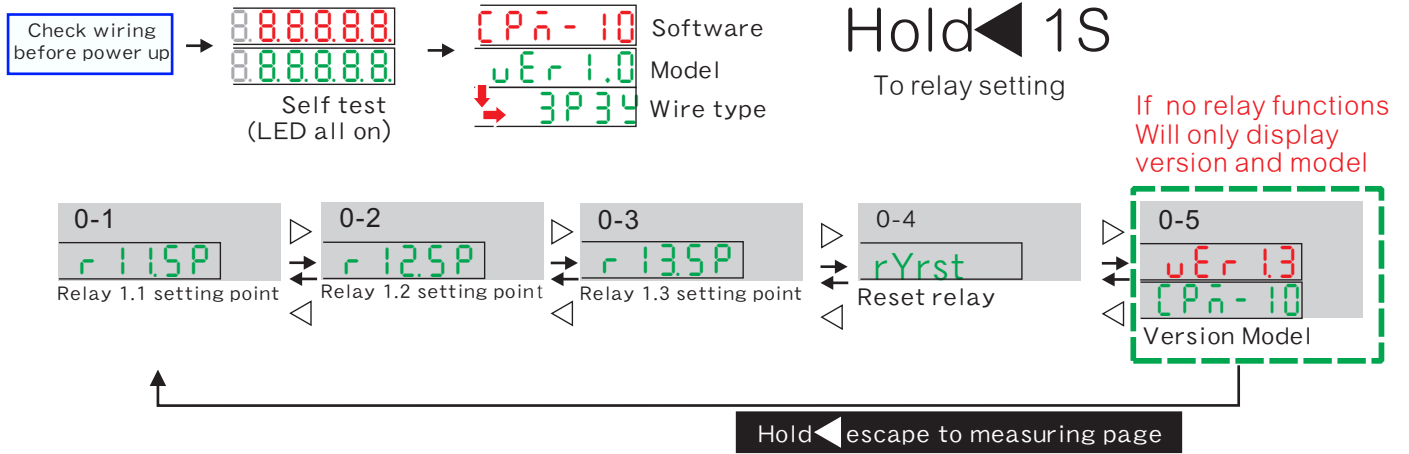

Parameter setting(A-1),connection different,will have a different display(tick shown)

	1P2W	1P3W	3P3W.1	3P3W.2	3P3W.3	3P4W.1	3P4W.3		1P2W	1P3W	3P3W.1	3P3W.2	3P3W.3	3P4W.1	3P4W.3		1P2W	1P3W	3P3W.1	3P3W.2	3P3W.3	3P4W.1	3P4W.3	
V.AVG	✓	✓	✓	✓	✓	✓	✓	VA			✓	✓	✓	✓	✓	✓	PA			✓	✓	✓	✓	✓
I.AVG	✓	✓	✓	✓	✓	✓	✓	VB			✓	✓	✓	✓	✓	✓	PB			✓	✓	✓	✓	✓
FREQ	✓	✓	✓	✓	✓	✓	✓	VC			✓	✓	✓	✓	✓	✓	PC			✓	✓	✓	✓	✓
P.TL	✓	✓	✓	✓	✓	✓	✓	IA	✓		✓	✓	✓	✓	✓	✓	QA			✓	✓	✓	✓	✓
Q.TL	✓	✓	✓	✓	✓	✓	✓	IB			✓	✓	✓	✓	✓	✓	QB			✓	✓	✓	✓	✓
S.TL	✓	✓	✓	✓	✓	✓	✓	IC	✓		✓	✓	✓	✓	✓	✓	QC			✓	✓	✓	✓	✓
PF.AVG	✓	✓	✓	✓	✓	✓	✓	PF-A			✓	✓	✓	✓	✓	✓	SA			✓	✓	✓	✓	✓
AETL	✓	✓	✓	✓	✓	✓	✓	PF-B			✓	✓	✓	✓	✓	✓	SB			✓	✓	✓	✓	✓
RE.TL	✓	✓	✓	✓	✓	✓	✓	PF-C			✓	✓	✓	✓	✓	✓	SC			✓	✓	✓	✓	✓

Press ▼  
Measuring page





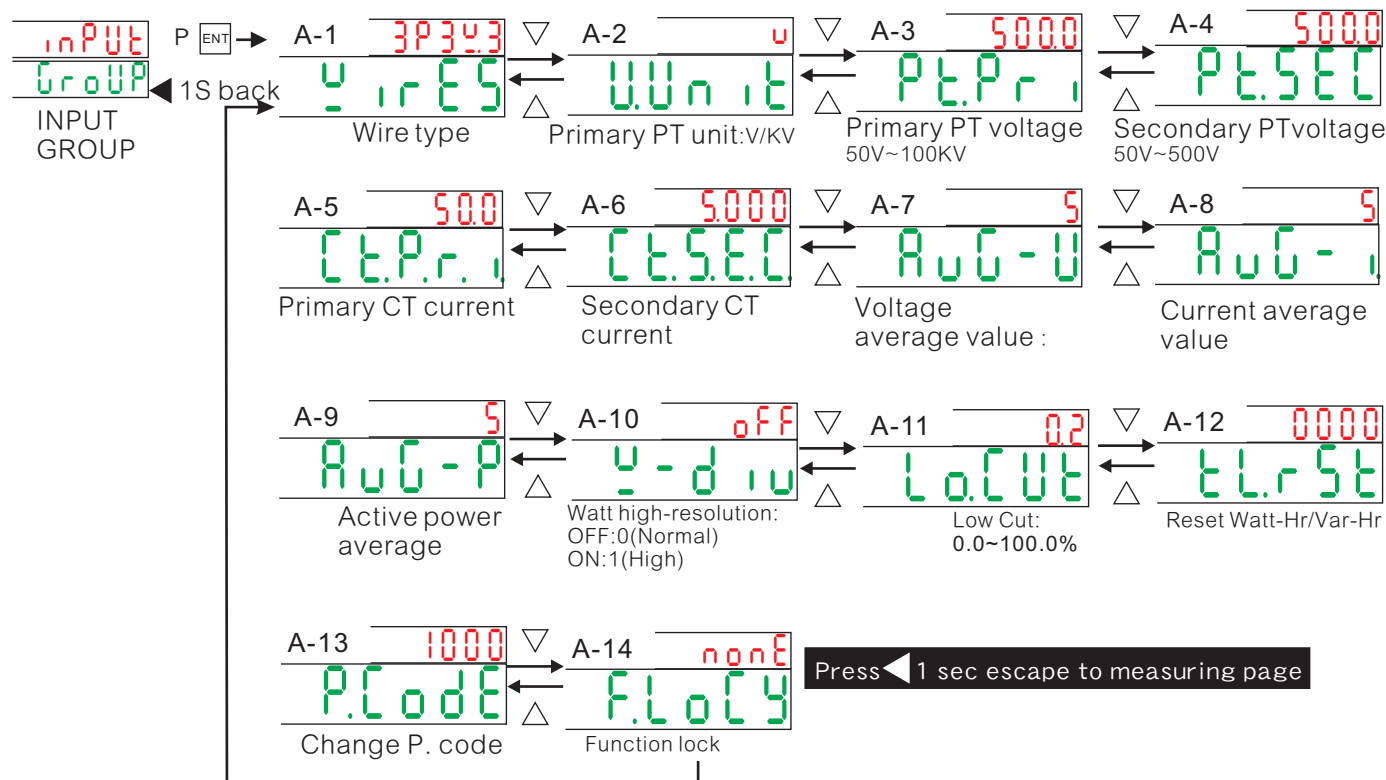
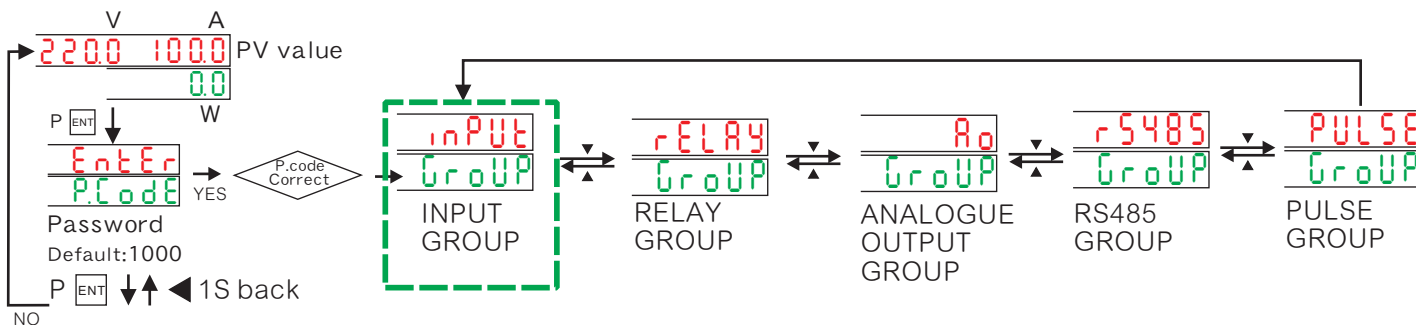

## Parameter Description

Index	Explain	Index	Explain
A-1	Wiring:1P2W / 1P3W/3P3W.1 / 3P3W.2/	A-7	Voltage average value :Range 2~99
A-2	Primary PT unit:V/KV	A-8	Current average value : Range 2~99
A-3	Primary PT voltage 50.0V~100KV	A-9	Active power average : Range 2~99
A-4	Secondary PTvoltage 50.0V~500V	A-12	Reset Watt-Hr/Var-Hr: 0~9999
A-5	Primary CT current 1.0A~2999.9A	A-13	Change P. code: 0000~9999
A-6	Secondary CT current	A-14	Function lock:NONE/USER/ENG/ALL

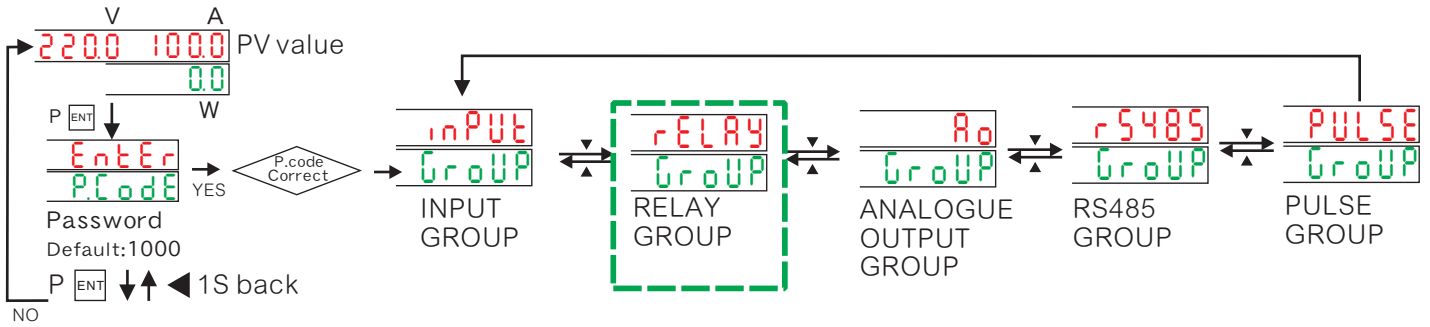

RELAY GROUP

B-1  $\bar{U}_{AVG}$   $\bar{r} 1.15L$  Relay R1.1 parameters:

B-2  $OFF$   $\bar{r} 1.1nd$  Relay R1.1 mode:

B-3  $3000$   $\bar{r} 1.15P$  Relay R1.1 set point:

B-4  $\bar{U}_{AVG}$   $\bar{r} 1.25L$  Relay R1.2 parameters same

B-5  $Lo$   $\bar{r} 1.2nd$  Relay R1.2 mode:

B-6  $2500$   $\bar{r} 1.25P$  Relay R1.2 set point

B-7  $FREQ$   $\bar{r} 1.35L$  Relay R1.3 parameters same as R1.1

B-8  $OFF$   $\bar{r} 1.3nd$  Relay R1.3 mode:

B-9  $4500$   $\bar{r} 1.35P$  Relay R1.3 set point:

B-10  $ADUNC$   $\bar{r} 1.15b$  Relay R1.1 start band

B-11  $000$   $\bar{r} 1.15d$  Relay R1.1 start delay

B-12  $0000$   $\bar{r} 1.1H9$  Relay R1.1 hysteresis:

B-13  $000$   $\bar{r} 1.1rd$  Relay R1.1 delay energize:

Program: BASIC back to B-1/ ADUNC down to B-11

B-15  $0000$   $\bar{r} 1.1Fd$  Relay R1.1 delay de-energize:

B-16  $000$   $\bar{r} 1.25b$  Relay R1.2 start band

B-17  $0000$   $\bar{r} 1.25d$  Relay R1.2 start delay

B-18  $000$   $\bar{r} 1.2H9$  Relay R1.2 hysteresis:

B-19  $0000$   $\bar{r} 1.2rd$  Relay R1.2 delay energize:

B-20  $0000$   $\bar{r} 1.2Fd$  Relay R1.2 delay de-energize:

B-21  $000$   $\bar{r} 1.35b$  Relay R1.3 start band

B-22  $0000$   $\bar{r} 1.35d$  Relay R1.3 start delay

B-23  $000$   $\bar{r} 1.3H9$  Relay R1.3 hysteresis:

B-24  $0000$   $\bar{r} 1.3rd$  Relay R1.3 delay energize:

B-25  $0000$   $\bar{r} 1.3Fd$  Relay R1.3 delay de-energize:

Press ◀ 1 sec escape to measuring page

## Parameter Description

Index	Explain	
B-1	Parameter settings:	Parameter settings:
B-4	$\bar{U}_{AVG}$ :3 Phase average voltage	PF - A :Phase A power factor
B-4	$\bar{S}_{AVG}$ :3 Phase apparent power	PF - b :Phase B power factor
B-7	FREQ :Frequency	PF - C :Phase C power factor
	$P_{tL}$ :3 Phase active power	P - A :Phase A active power factor
	$Q_{tL}$ :3 Phase reactive power	P - b :Phase B active power factor
	$S_{tL}$ :3 Phase apparent power	P - C :Phase C active power factor
	PF $\bar{U}_{AVG}$ :3 Phase average power factor	q - A :Phase A reactive power
	$\bar{U}_A$ :Phase A voltage	q - b :Phase B reactive power
	$\bar{U}_b$ :Phase B voltage	q - C :Phase C reactive power
	$\bar{U}_C$ :Phase C voltage	S - A :Phase A apparent power
	$\bar{I}_A$ :Phase A current	S - b :Phase B apparent power
	$\bar{I}_b$ :Phase B current	S - C :Phase C apparent power
	$\bar{I}_C$ :Phase C current	



# Parameter Description

Index	Explain
B-2 B-5 B-8	Relay mode: LO/Hi/LO.HLD/ Hi.HLD/DO/OFF
B-3 B-6 B-9	Relay set point range: -199.99~299.99
B-11 B-16 B-21	Relay start band:0.00~99.99 (count)
B-12 B-17 B-22	Relay start delay times: 0.00.00~9.59.9(min/sec/0.1s)
B-13 B-18 B-23	Relay hysteris:0.00~50.00(count)
B-14 B-19 B-24	Relay delay energize: 0.00.0~9.59.9(min/sec/0.1s)
B-15 B-20 B-25	Relay delay de-energize: 0.00.0~9.59.9(min/sec/0.1s)

Lo(Low Level Energized) :  
When the displayed value is lower than the set value (PV < Set point), the relay action °

Hi(High Level Energized) :  
When the displayed value is higher than the set value (PV > Set point), the relay action °

Lo.hld:  
(Low Level energized hold) : Displayed value lower than set value action, and continued to maintain action.

Hi.HLD:  
(High Level energized hold) : Displayed value higher than the set value, the action, and continued to maintain action. °

DO:(Digital Output) : With RS485 function, the relay can be used as a function of DO force the relay action from the RS485 command °

## Engineer level

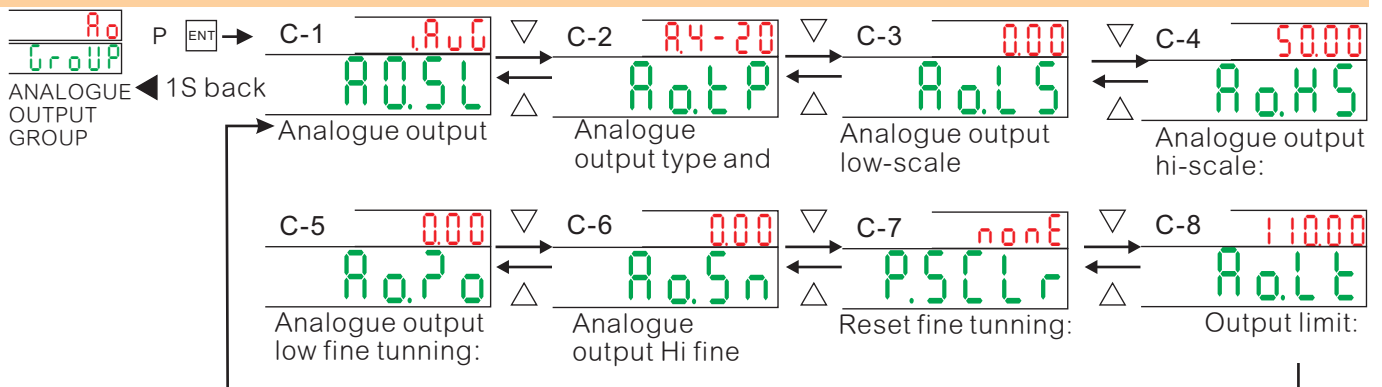
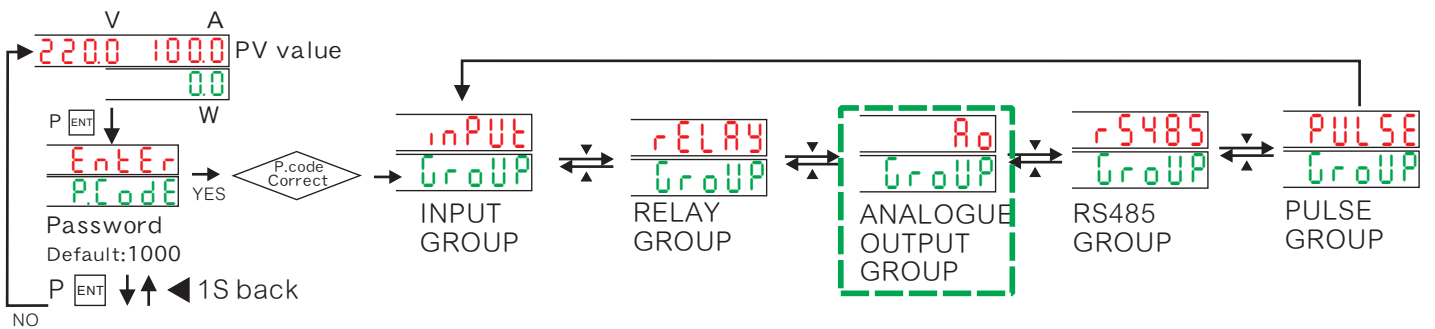

Press ◀ 1 sec escape to measuring page

# Parameter Description

Index	Explain	
C-1	AO corresponding the parameters: $\bar{u} \cdot \bar{R} \cdot \bar{C}$ :3 Phase average voltage $\bar{i} \cdot \bar{R} \cdot \bar{C}$ :3 Phase apparent power $F r E \varphi$ :Frequency $P \cdot \bar{t} L$ :3 Phase active power $Q \cdot \bar{t} L$ :3 Phase reactive power $S \cdot \bar{t} L$ :3 Phase apparent power $P F \cdot \bar{R} \cdot \bar{C}$ :3 Phase average power factor $\bar{u} \bar{R}$ :Phase A voltage $\bar{u} \bar{b}$ :Phase B voltage $\bar{u} \bar{C}$ :Phase C voltage $\bar{i} \bar{R}$ :Phase A current $\bar{i} \bar{b}$ :Phase B current $\bar{i} \bar{C}$ :Phase C current	AO corresponding the parameters: $P F - \bar{R}$ :Phase A power factor $P F - \bar{b}$ :Phase B power factor $P F - \bar{C}$ :Phase C power factor $P - \bar{R}$ :Phase A active power factor $P - \bar{b}$ :Phase B active power factor $P - \bar{C}$ :Phase C active power factor $Q - \bar{R}$ :Phase A reactive power $Q - \bar{b}$ :Phase B reactive power $Q - \bar{C}$ :Phase C reactive power $S - \bar{R}$ :Phase A apparent power $S - \bar{b}$ :Phase B apparent power $S - \bar{C}$ :Phase C apparent power
C-2	Output signal of type and range : A.0-10/A.0-20/A.4-20/ A.4B.20/A.B.10/A.B.20/ V.0-5/V.1-5/V.0-10/V.0B.5/	Current: A0-10:0~10A A0-20:0~20A A.4-20:4~20A A.4B20:4~12~20A Ab10:±10A Ab20:±20A Voltage: V0-5:0~5V V1-5:1~5V V0-10:0~10V V0B5:0~2.5~5V V1B5:1~3~5V V0B10:0~5~10V Vb5:±5V Vb10:±10V
C-3	Analogue output low-scale: -19999~29999	C-4 Analogue output hi-scale: -19999~29999
C-5	Analogue output low fine tuning::	C-6 Analogue output Hi fine tuning: -32768~32767
C-7	Reset fine tuning: NONE/AO.ZRO/AO.SPN/BOTH	$n o n E$ (NONE): Does not clear the correction $R a . P r o$ (Ao.Zro): Clear the lower limit of fine-tuning $R a . S P n$ (Ao.SPn): Clear upper limit of fine-tuning $b o t h$ (both): Clear the lower limit, upper limit of fine-tuning correction
C-8	Output limit:0~110 %	

## Engineer level

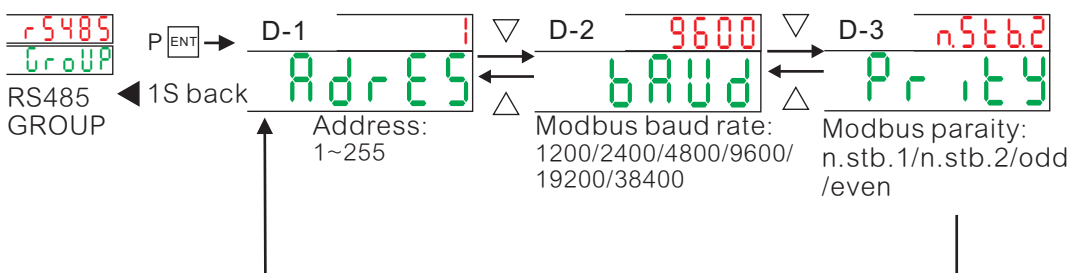
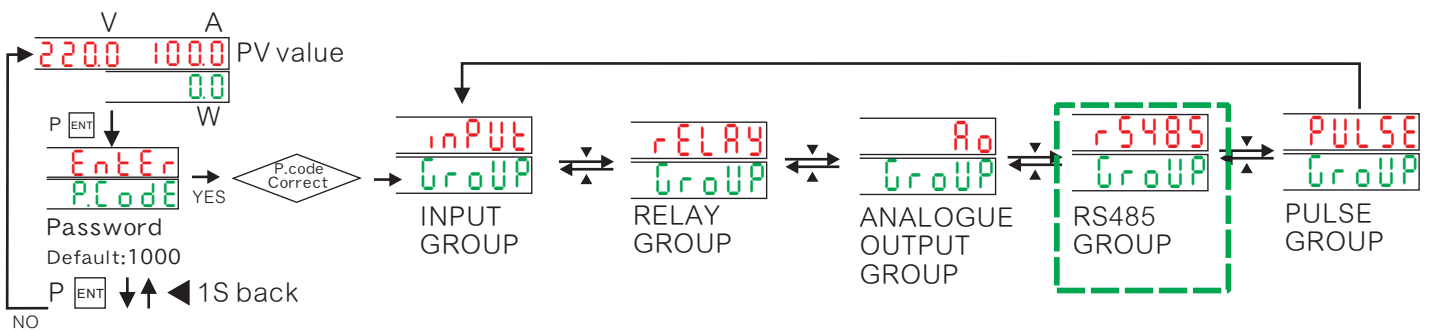

Press ◀ 1 sec escape to measuring page

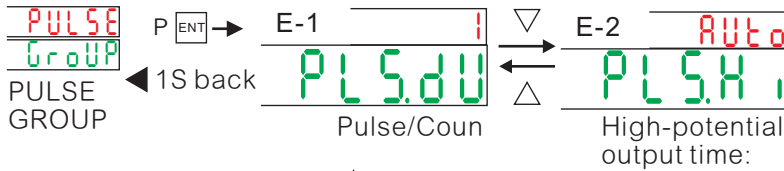
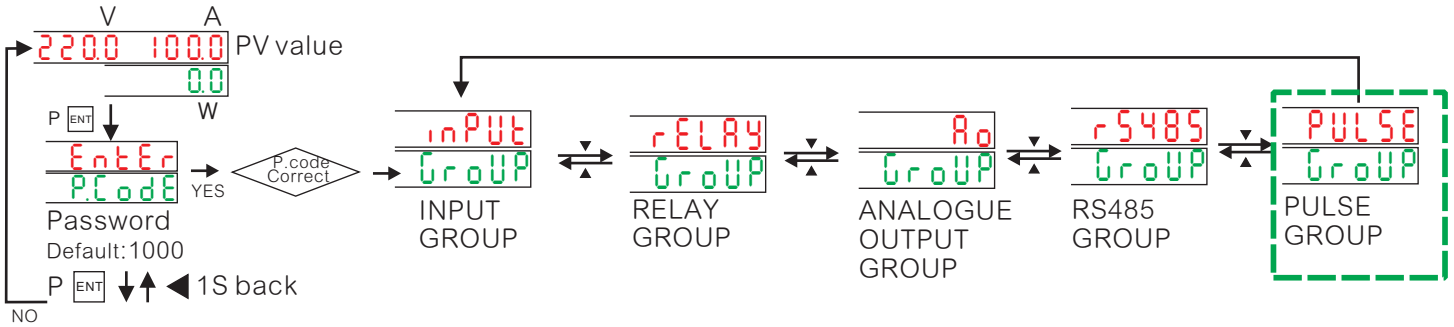

RELAY / PULSE output of the outputs can only choose a functional output  
 EX: Select PULSE output and then RELAY function no output and vice versa













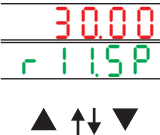









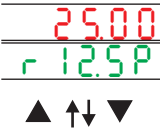

















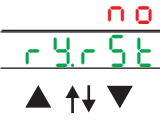

Press ◀ 1 sec escape to measuring page

## Parameter Description

Index	Explain	
E-1	Pulse output/Count setting: 1~9999	※When set 1, mean 1 count watt hr give 1 pulse: When set 1000, mean 1000 count watt hr give 1 pulse ,
E-2	Hi-voltage output time: 0(AUTO)~500 0	※When set 0, mean Duty cycle is 50% ; setting 1~5000(x4ms.) time length , please beware at long time length, high frequency the output may remain at H-voltage and not completing a full pulse cycle, resulting data not readable.





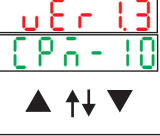
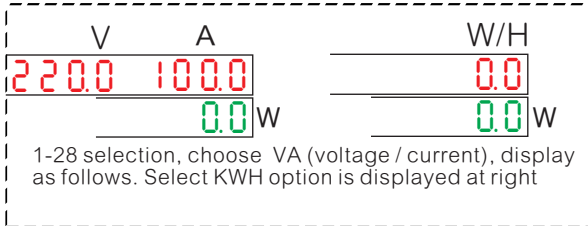



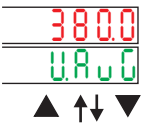
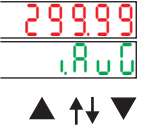

# Operating Steps

## User Level

Parameters	Display	Setting	Operation
<p>Power on Check the wiring</p> 	Self test LED all on		No need to set
	Wiring Model Version	Press ◀1Sec Into the relay function	
<p>0-1</p> 	Relay 1.1 funtion setting	Relay R1.1 value range:-199.99~299.99	 Shift  Increase  Decrease  Enter Press  values blink,press  &  change value or selection when done press  to next setting or hold  1 sec to previous selection list.
<p>0-2</p> 	Relay 1.2 funtion setting	Relay R1.2 value range:-199.99~299.99	 Shift  Increase  Decrease  Enter Press  values blink,press  &  change value or selection when done press  to next setting or hold  1 sec to previous selection list.
<p>0-3</p> 	Relay 1.3 funtion setting	Relay R1.3 value range:-199.99~299.99	 Shift  Increase  Decrease  Enter Press  values blink,press  &  change value or selection when done press  to next setting or hold  1 sec to previous selection list.
<p>0-4</p> 	Reset relay function	Select:4E5 /no	 Shift  Increase  Decrease  Enter Press  values blink,press  &  change value or selection when done press  to next setting or hold  1 sec to previous selection list.
<p>0-5</p> 	Version Model	There is no relay functions Will only display version	View only  Press ▼ 1 sec escape to begining page Press ◀ 1 sec escape to measuring page.
Back to 0-1			
			



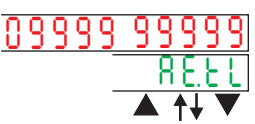
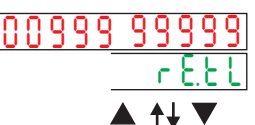



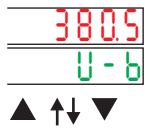

# Operating Steps

## User Level

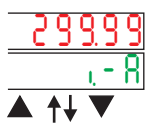
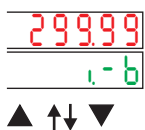
Parameters	Display	Setting	Operation
Power on Check the wiring 	Self test LED all on		No need to set
	Wiring Model Version	Press ◀1Sec Into the measurement menu	
1-1 	3 Phase voltage average value	View only	The average voltage is the average of the voltage relative N ° $V.AVG=(V_{an}+V_{bn}+V_{cn})/3$ Voltage readings need to be interpreted in conjunction with voltage unit V or KV °
1-2 	3 Phase current average value	View only	The average current is the average flowing through the line current ° $I.AVG=(I_a+I_b+I_c)/3$ Displayed as the current units of ampere °
1-3 	Frequency	View only	Frequency is taken between the Van voltage frequency ° Range:45.00~75.00 Hz exceed Frequency range will affect the other parameters the accuracy of the reading °
1-4 	3 Phase power factor total	View only	The total effective power is the sum of each phase effective power ° The power of reading needs with the unit MW, KW or W °
1-5 	3 Phase reactive power	View only	Total invalid power is the power of total ° The power of reading needs with the unit MW, KW or W °
1-6 	3 Phase active power	View only	The power of reading needs with the unit MW, KW or W °
1-7 	3 Phase power factor average	View only	Total power factor (PF) = total effective power (P) / total apparent power (S)
1-8 	3 Phase total energy Watt-hr	View only Parameter based on P ◻ 1.5 L corresponding display	The only 5-digit display, but the cumulative number of bits to 8 digits, so into the down 4-digit "-9999", and the up 4 digits "9999 -" The 2 show ° Reading needs with the unit MW, KW or
1-9 	3 Phase reactive energy Var-hr	View only Parameter based on P ◻ 2.5 L corresponding display	The only 5-digit display, but the cumulative number of bits to 8 digits, so into the down 4-digit "-9999", and the up 4 digits "9999 -" The 2 show ° Reading needs with the unit MW, KW or
1-10 	A Phase voltage	View only	

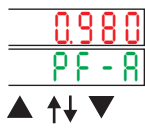
# Operating Steps

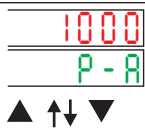
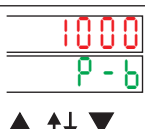

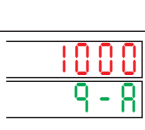







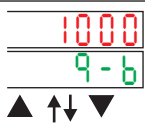
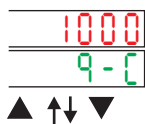
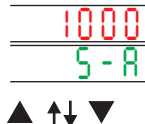
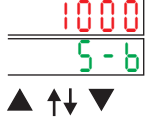

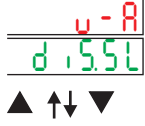
## User Level

Parameters	Display	Setting	Operation
1-11 	B Phase voltage	View only	<p>Each phase voltage refers to the relative N and white voltage ° <math>V_a(V_b \setminus V_c)</math> with <math>V_n</math> voltage ° 3P4W wiring, only to show the line voltage of N, if you want to understand the line to line voltage, is only the value multiplied by 1.732. °</p> <p>3P3W wiring, S need to short circuit and N, so the only <math>V_{ab}</math> and <math>V_{ca}</math> value and read value is the line voltage °</p> <p>Reading needs with the unit KV or V °</p>
1-12 	C Phase voltage	View only	
1-13 	A Phase current	View only	<p>Each phase current is flowing through the line current ° <math>I_a \setminus I_b \setminus I_c</math> current °</p> <p>Current unit is ampere °</p>
1-14 	B Phase current	View only	
1-15 	C Phase current	View only	
1-16 	A Phase power factor	View only	<p>3P3W system, the system in "a phase current lag behind voltage 30 degree angle, "and" c phase current leads the voltage 30 degree angle", so the total power factor of 1.00, PF-A will be = 0.866, PF-C will be = -0.866, so the display is a normal phenomenon °</p>
1-17 	B Phase power factor	View only	
1-18 	C Phase power factor	View only	
1-19 	A Phase active power	View only	<p>Reading needs with the unit MW, KW or W °</p>
1-20 	B Phase active power	View only	
1-21 	C Phase active power	View only	
1-22 	A Phase reactive power	View only	



# Operating Steps

## User Level













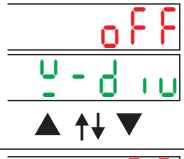













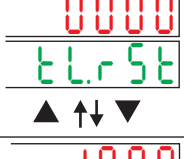

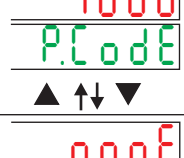

Parameters	Display	Setting	Operation
1-23 	B Phase reactive power	View only	Reading needs with the unit M \ K or None(var) °
1-24 	C Phase reactive power	View only	
1-25 	A Phase apparent power	View only	Reading needs with the unit M \ K or None(var) °
1-26 	B Phase apparent power	View only	
1-27 	C Phase apparent power	View only	
1-28 	Select V-A/KWH	V-A/KWH	<p>Press  values blink, press  &amp;  change value or selection when done press  to next setting or hold  1 sec. to previous selection list</p> <p> Shift     Increase     Decrease     Enter</p>
Back to 1-1	Press  1 sec to measuring page		

# Operating Steps





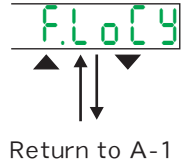





<span style="font-size: 1.2em;">Engineer level</span> <span style="float: right; font-size: 0.8em;">  Shift                         Increase                         Decrease                         Enter                 </span>			
Parameters	Display	Setting	Operation
<div style="display: flex; justify-content: space-between;"> <div style="width: 20%;"> </div> <div style="width: 60%; border: 2px dashed red; padding: 5px; text-align: center; color: red;">                 RELAY / PULSE output of the outputs can only choose a functional output                  EX: Select PULSE output and then RELAY function no output and vice versa             </div> </div>			
<p>按 [ENT] ↑↓ P 1s Back</p>	INPUT GROUP Display		
A-1 <p>▲ ↑↓ ▼</p>	Input system selection: WIRES	Range: 1P2W/1P3W/3P3W.1/ 3P3W.2/3P3W.3/ 3P4W.1/3P4W.3	1P2W:1Phase 2 Wire 1P3W:1Phase 3 Wire 3P3W.1:3Phase 3 Wire 1CT(balanced) 、 3P3W.2:3Phase 3 Wire 2CT 、 3P3W.3:3Phase 3 Wire 3CT 、 3P4W.1:3Phase 4 Wire 1CT(balanced) 、 3P4W.3:3Phase 4 Wire 3CT °
A-2 <p>▲ ↑↓ ▼</p>	Primary PT voltage unit: V.Unit	V / KV	Range: u / k u Press [ENT] values blink, press,  &  change value or selection when done press [ENT] to next setting or hold  1 sec. to previous selection list
A-3 <p>▲ ↑↓ ▼</p>	Primary voltage setting range	Setting range: 50.0V~100KV	Shift     Increase     Decrease     Enter ※Please note that this setting is the choice of the corresponding primary voltage units. For example, if Vunit kv, while this pTpri set to 45) 0, then the set primary voltage for 450.0KV. °
A-4 <p>▲ ↑↓ ▼</p>	Secondary voltage setting range	Setting range: 50.0V~500V	Press [ENT] values blink, press,  &  change value or selection when done press [ENT] to next setting or hold  1 sec. to previous selection list
A-5 <p>▲ ↑↓ ▼</p>	Primary CT setting range	Setting range: 1.0A~2999.9A	Shift     Increase     Decrease     Enter
A-6 <p>▲ ↑↓ ▼</p>	Secondary CT setting range	(VIEW ONLY)	Press [ENT] values blink, press,  &  change value or selection when done press [ENT] to next setting or hold  1 sec. to previous selection list
A-7 <p>▲ ↑↓ ▼</p>	Average voltage setting:	Setting range: 2~99	Shift     Increase     Decrease     Enter ※System may have interference or signal unstable sometimes, causing display unstable: This function help to decrease rapid change on the display. Increasing average value make display more stable,
A-8 <p>▲ ↑↓ ▼</p>	Average current setting:	Setting range: 2~99	Shift     Increase     Decrease     Enter ※System may have interference or signal unstable sometimes, causing display unstable: This function help to decrease rapid change on the display. Increasing average value make display more stable,

# Operating Steps

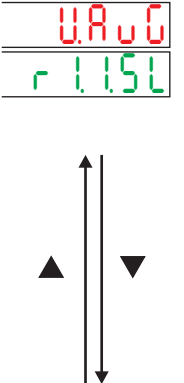
## Engineer level

Parameters	Display	Setting	Operation
A-9		Setting range:2~99	 ※System may have interference or signal unstable sometimes, causing display unstable: This function help to decrease rapid change on the display. Increasing average value make display more stable,
A-10		Setting range: OFF:0(Normal) ON:1(High)  ※Default:OFF	 Press  values blink,press,  &  change value or selection when done press  to next setting or hold  1 sec. to previous selection list
A-11		Setting range:0.0~100.0%  ※Default:0.2	 Press  values blink,press,  &  change value or selection when done press  to next setting or hold  1 sec. to previous selection list
A-12		Password:0~9999  ☐ Rs485 Key in 0 to reset ☐	 Press  values blink,press,  &  change value or selection when done press  to next setting or hold  1 sec. to previous selection list
A-13		Password:0000~9999	 Press  values blink,press,  &  change value or selection when done press  to next setting or hold  1 sec. to previous selection list
A-14	 Return to A-1	Function lock select: NONE/USER/ENG/ALL	 none None: No function lock, user can enter and change setting User (User Level):User level lock,can view setting cant change parameters value Eng (Programming Level): Parameters setting lock ,can view setting cant change parameters value All (All Level): All level lock , can view setting cant change parameters value



## Engineer level (Raelly Output)

Parameters	Display	Setting	Operation																																																						
	 按    P 1s Back		Press  1 sec [RELAY GROUP]																																																						
B-1		Reference to corresponding table(table B-1)  Default:V.AVG  <table style="font-size: small; border-collapse: collapse;"> <tr><td>u .AUG</td><td>3 Phase average voltage</td></tr> <tr><td>. .AUG</td><td>3 Phase average current</td></tr> <tr><td>F r E q</td><td>Frequency</td></tr> <tr><td>P . t L</td><td>3 Phase active power</td></tr> <tr><td>q . t L</td><td>3 Phase reactive power</td></tr> <tr><td>S . t L</td><td>3 Phase apparent power</td></tr> <tr><td>P F . RUG</td><td>3 Phase power factor</td></tr> <tr><td>R E . t L</td><td>3 Phase Watt-hr</td></tr> <tr><td>r E . t L</td><td>3 Phase Var-hr</td></tr> <tr><td>u - A</td><td>A Phase voltage</td></tr> <tr><td>u - b</td><td>B Phase voltage</td></tr> <tr><td>u - C</td><td>C Phase voltage</td></tr> <tr><td>i - A</td><td>A Phase current</td></tr> <tr><td>i - b</td><td>B Phase current</td></tr> <tr><td>i - C</td><td>C Phase current</td></tr> <tr><td>P F - A</td><td>A Phase power factor</td></tr> <tr><td>P F - b</td><td>B Phase power factor</td></tr> <tr><td>P F - C</td><td>C Phase power factor</td></tr> <tr><td>P - A</td><td>A Phase active power</td></tr> <tr><td>P - b</td><td>B Phase active power</td></tr> <tr><td>P - C</td><td>C Phase active power</td></tr> <tr><td>q - A</td><td>A Phase reactive power</td></tr> <tr><td>q - b</td><td>B Phase reactive power</td></tr> <tr><td>q - C</td><td>C Phase reactive power</td></tr> <tr><td>S - A</td><td>A apparent power</td></tr> <tr><td>S - b</td><td>B apparent power</td></tr> <tr><td>S - C</td><td>C apparent power</td></tr> </table>	u .AUG	3 Phase average voltage	. .AUG	3 Phase average current	F r E q	Frequency	P . t L	3 Phase active power	q . t L	3 Phase reactive power	S . t L	3 Phase apparent power	P F . RUG	3 Phase power factor	R E . t L	3 Phase Watt-hr	r E . t L	3 Phase Var-hr	u - A	A Phase voltage	u - b	B Phase voltage	u - C	C Phase voltage	i - A	A Phase current	i - b	B Phase current	i - C	C Phase current	P F - A	A Phase power factor	P F - b	B Phase power factor	P F - C	C Phase power factor	P - A	A Phase active power	P - b	B Phase active power	P - C	C Phase active power	q - A	A Phase reactive power	q - b	B Phase reactive power	q - C	C Phase reactive power	S - A	A apparent power	S - b	B apparent power	S - C	C apparent power	 Press  values blink,press,  &  change value or selection when done press  to next setting or hold  1 sec. to previous selection list  Note: R1.1/R1.2/R1.3 is only one relay output function, but three mode (.1/.2./3-) group can be set to function  In (.1/.2./3) group within any parameters set the conditions for the establishment of the relay action. But when the three groups of conditions have not set up the relay is still conduction until three parameter is not set up until reversion  EX: the R1.1 setting parameters for u .AUG , when the R1.2 setting parameters to set parameters for i .RUG , R1.3 F r E q . Only R1.1 current average set point is reached, the relay actionuntil below the set point automatically reset.  When the three set parameters set point is reached, if only to exclude the R1.1 set point, then the relay is still action, until the R1.2 with R1.3 setpoint exclusion will revert to.
u .AUG	3 Phase average voltage																																																								
. .AUG	3 Phase average current																																																								
F r E q	Frequency																																																								
P . t L	3 Phase active power																																																								
q . t L	3 Phase reactive power																																																								
S . t L	3 Phase apparent power																																																								
P F . RUG	3 Phase power factor																																																								
R E . t L	3 Phase Watt-hr																																																								
r E . t L	3 Phase Var-hr																																																								
u - A	A Phase voltage																																																								
u - b	B Phase voltage																																																								
u - C	C Phase voltage																																																								
i - A	A Phase current																																																								
i - b	B Phase current																																																								
i - C	C Phase current																																																								
P F - A	A Phase power factor																																																								
P F - b	B Phase power factor																																																								
P F - C	C Phase power factor																																																								
P - A	A Phase active power																																																								
P - b	B Phase active power																																																								
P - C	C Phase active power																																																								
q - A	A Phase reactive power																																																								
q - b	B Phase reactive power																																																								
q - C	C Phase reactive power																																																								
S - A	A apparent power																																																								
S - b	B apparent power																																																								
S - C	C apparent power																																																								

# Operating Steps

<span style="font-size: 1.2em;">Engineer level (Raely Output)</span> <span style="float: right; font-size: 0.8em;">  Shift                         Increase                         Decrease                         Enter                 </span>			
Parameters	Display	Setting	Operation
B-2  	Relay R1.1	Setting type: L.o./H.i./L.o..H.L.d./H.i..H.L.d./ d.o./o.F.F.	Shift                         Increase                         Decrease                         Enter Press  values blink,press,  &  change value or selection when done press  to next setting or hold  1 sec. to previous selection list  L.o. : PV < Setpoint , relay energized ° H.i. : PV > Setpoint , relay energized ° L.o..H.L.d. : Display < Setpoint , relay energized, and hold energized status ° H.i..H.L.d. : Display > Setpoint , relay energized, and hold energized status ° d.o. : Using Rs485 communication,relay can act as DO,command relay to energized. ° o.F.F. : Close relay function,when relay is off ,relay remain open, LED will not light °
B-3  	Relay R1.1 value setting:	Setting range: -199.99~299.99	Press  values blink,press,  &  change value or selection when done press  to next setting or hold  1 sec. to previous selection list
B-4  	Relay R1.2 Mode:	Relay R1.2 setting type :same R1.1	Press  values blink,press,  &  change value or selection when done press  to next setting or hold  1 sec. to previous selection list
B-5  	Relay R1.2 Mode:	Setting type: L.o./H.i./L.o..H.L.d./H.i..H.L.d./ d.o./o.F.F.	Press  values blink,press,  &  change value or selection when done press  to next setting or hold  1 sec. to previous selection list
B-6  	Relay R1.2 value setting:	Setting range: -199.99~299.99	Press  values blink,press,  &  change value or selection when done press  to next setting or hold  1 sec. to previous selection list
B-7  	Relay R1.3 Mode:	Relay R1.3 setting type:same R1.1	Press  values blink,press,  &  change value or selection when done press  to next setting or hold  1 sec. to previous selection list
B-8  	Relay R1.3 Mode:	Setting type: L.o./H.i./L.o..H.L.d./H.i..H.L.d./ d.o./o.F.F.	Press  values blink,press,  &  change value or selection when done press  to next setting or hold  1 sec. to previous selection list
B-9  	Relay R1.3 value setting:	Setting range: -199.99~299.99	Press  values blink,press,  &  change value or selection when done press  to next setting or hold  1 sec. to previous selection list
B-10  	Program selection:	prog (Programming for basic or advance setting ):	Shift                         Increase                         Decrease                         Enter In parameters setting level, default is basic · during setting , it only show common functions,advance functions is hidden.User can change setting in each group , [ P r o G ] set it AdvnC (advance) to show all functions.

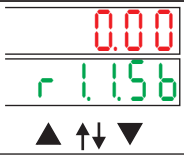
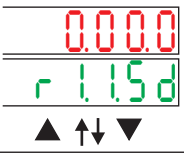
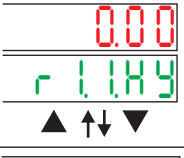
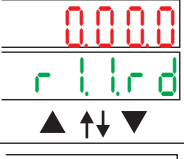
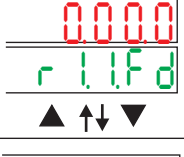
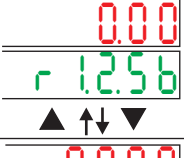
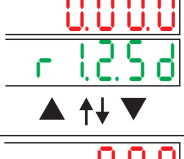
# Operating Steps

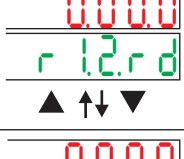
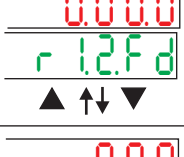
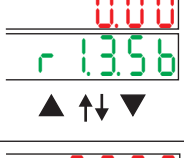
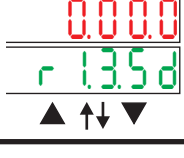
Engineer level (Raely Output) <span style="float: right; font-size: 0.8em; margin-left: 20px;">  Shift              Increase              Decrease              Enter           </span>			
Parameters	Display	Setting	Operation
B-11		Relay R1.1 start band: Setting range: 00.00~99.99	Shift            Increase            Decrease            Enter  When display exceed set start band and after Start delay time ,then relay compare PV value, energized.
B-12		Relay R1.1 start delay time: Setting range: 0.00.0~9.59.9	Press  values blink,press,  &  change value or selection when done press  to next setting or hold  1 sec. to previous selection list
B-13		Relay R1.1 hysteresis time: Setting range: 0.00~50.00	Press  values blink,press,  &  change value or selection when done press  to next setting or hold  1 sec. to previous selection list
B-14		Relay R1.1 start delay time: Setting range: 0.00.0~9.59.9	Press  values blink,press,  &  change value or selection when done press  to next setting or hold  1 sec. to previous selection list
B-15		Relay R1.1 de-energized delay time: Setting range: 0.00.0~9.59.9	Press  values blink,press,  &  change value or selection when done press  to next setting or hold  1 sec. to previous selection list
B-16		Relay R1.2 start band: Setting range: 0.00~99.99	Shift            Increase            Decrease            Enter  When display exceed set start band and after Start delay time ,then relay compare PV value, energized.
B-17		Relay R1.2 start delay time Setting range: 0.00.0~9.59.9	Press  values blink,press,  &  change value or selection when done press  to next setting or hold  1 sec. to previous selection list
B-18		Relay R1.2 hysteresis time: Setting range: 0.0~50.00	Press  values blink,press,  &  change value or selection when done press  to next setting or hold  1 sec. to previous selection list
B-19		Relay R1.2 start delay time: Setting range: 0.00.0~9.59.9	Press  values blink,press,  &  change value or selection when done press  to next setting or hold  1 sec. to previous selection list
B-20		Relay R1.2 de-energized delay time: Setting range: 0.00.0~9.59.9	Press  values blink,press,  &  change value or selection when done press  to next setting or hold  1 sec. to previous selection list
B-21		Relay R1.3 start delay time: Setting range: 0.00~99.99	Shift            Increase            Decrease            Enter  When display exceed set start band and after Start delay time ,then relay compare PV value, energized.
B-22		Relay R1.3 start delay time: Setting range: 0.00.0~9.59.9	Press  values blink,press,  &  change value or selection when done press  to next setting or hold  1 sec. to previous selection list

# Operating Steps

Engineer level (Raely Output)			
Parameters	Display	Setting	Operation
B-23		Relay R1.3 hysteresis time: Setting range:0.00~50.00	Press  values blink,press,  &  change value or selection when done press  to next setting or hold  1 sec. to previous selection list
B-24		Relay R1.3 start delay time: Setting range: 0.00.0~9.59.9	Press  values blink,press,  &  change value or selection when done press  to next setting or hold  1 sec. to previous selection list
B-25		Relay R1.3 de-energized delay time: Setting range: 0.00.0~9.59.9	Press  values blink,press,  &  change value or selection when done press  to next setting or hold  1 sec. to previous selection list
Return to B-1	Press  1 sec to measuring page		

Engineer level (AO Output)			
Parameters	Display	Setting	Operation
		ANALOGUE OUTPUT Display	Press  1 sec to [AO GROUP]
C-1		Analogue output parameters setting: <ul style="list-style-type: none"> <li>u .R u G 3 Phase average voltage</li> <li>i .R u G 3 Phase average current</li> <li>F r E q Frequency</li> <li>P .t L 3 Phase active power</li> <li>q .t L 3 Phase reactive power</li> <li>S .t L 3 Phase apparent power</li> <li>P F .R u G 3 Phase power factor</li> <li>R E .t L 3 Phase Watt-hr</li> <li>r E .t L 3 Phase Var-hr</li> <li>u - R A Phase voltage</li> <li>u - b B Phase voltage</li> <li>u - C C Phase voltage</li> <li>i - R A Phase current</li> <li>i - b B Phase current</li> <li>i - C C Phase current</li> <li>P F - R A A Phase power factor</li> <li>P F - b B Phase power factor</li> <li>P F - C C Phase power factor</li> <li>P - R A A Phase active power</li> <li>P - b B Phase active power</li> <li>P - C C Phase power factor</li> <li>q - R A A Phase reactive power</li> <li>q - b B Phase reactive power</li> <li>q - C C Phase reactive power</li> <li>S - R A A apparent power</li> <li>S - b B apparent power</li> <li>S - C C apparent power</li> </ul>	Press  values blink,press,  &  change value or selection when done press  to next setting or hold  1 sec. to previous selection list
C-2		Analogue output range Setting range:Voltage/Current	<p>Voltage: R0-10:0~10A R0-20:0~20A R.4-20:4~20A R.4b.20:4~12~20A R.b 10:±10A R.b 20:±20A</p> <p>Current: u0-5:0~5V u.1-5:1~5V u0-10:0~10V u0b.5:0~2.5~5V u.1b.5:1~3~5V u0b.10:0~5~10V u.b 5:±5V u.b 10:±10V</p>









# Operating Steps

Engineer level (AO Output)			
Parameters	Display	Setting	Operation
C-3		A/O Low scale range: Setting range: -199.99~299.99	Shift  Increase  Decrease  Enter Ex: When A/O set R4 - 20 (4~20mA) display value as 0~199.99 user may set [AoLS] (Ao.LS) 5 so when, display value is 5 , A/O will give 4mA output
C-4		A/O high scale range: Setting range: -199.99~299.99	Shift  Increase  Decrease  Enter Ex: When A/O set R4 - 20 (4~20mA) display value as 0~199.99 user may set [AoHS] (Ao.HS) 15 so when, display value is 15 , A/O will give 20mA output
C-5		A/O signal zero fine tuning: Setting range: -32768~32767	Shift  Increase  Decrease  Enter When A/O low value is different from display (low), fine tuning can be done from front panel. During tuning please connect a higher accuracy meter, to measure output signal, so as calibration is within accuracy
C-6		A/O signal span fine tuning: Setting range: -32768~32767	Shift  Increase  Decrease  Enter When A/O high value is different from display (high), fine tuning can be done from front panel. During tuning please connect a higher accuracy meter, to measure output signal, so as calibration is within accuracy °
C-7		Clear fine tuning value: Setting range: NONE/AO.ZRO/AO.SPN/BOTH	Cycle  Enter none: None clear Ao.Zro: Zero clear Ao.SPN: Span clear both: Zero & span clear
C-8		A/O range limit: Setting range in %:0.00~110.00%	Shift  Increase  Decrease  Enter Press  values blink, press,  &  change value or selection when done press  to next setting or hold  1 sec. to previous selection list
Back to C-1		Press  1 sec to measuring page	

Engineer level (RS485 Output)			
Parameters	Display	Setting	Operation
 RS485 GROUP Display 按     P 1s Back			
D-1		Address setting: Setting range:1~255	Press  values blink, press,  &  change value or selection when done press  to next setting or hold  1 sec. to previous selection list
D-2		Modbus Baud rate: Setting range: 1200/2400/4800/9600/19200/38400	Press  values blink, press,  &  change value or selection when done press  to next setting or hold  1 sec. to previous selection list
D-3		Modbus pairty bit: Setting range: n.stb.1/.stb.2/odd/even	Cycle  Enter n5tb.1 (n.Stb.1): None, 1 stop bit n5tb.2 (n.Stb.2): None, 2 stop bit odd (odd): odd EvEn (EvEn): Even
Back to D-1		Press  1 sec to measuring page	

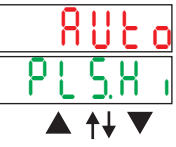
# Operating Steps

Engineer level (Pulse Output)			
Parameters	Display	Setting	Operation
 <p>PULSE GROUP 按 [ENT] ↓↑ ◀ P 1s Back</p>	PULSE GROUP Display		 <p>Press ◀ 1 sec to [PULSE GROUP]</p>
<p>E-1</p>  <p>▲ ↑↓ ▼</p>	Pulse output /Count setting:	Setting range:1~9999	 <p>※When set 1,mean 1 count watt hr give 1 pulse: When set 1000, mean 1000 count watt hr give 1 pulse ,</p>
<p>E-2</p>  <p>▲ ↑↓ ▼ Back to E-1</p>	Hi-voltage output time:	Setting range: 0(AUTO)~5000 ( x 4ms)	 <p>※When set 0, mean Duty cycle.is 50% ; setting 1~5000(x4ms.) time length , please beware at long time length, high frequency the output may remain at H-voltage and not completing a full pulse cycle, resulting data not readable.</p>
<p>Press ◀ 1 sec to measuring page</p>			<p>RELAY / PULSE output of the outputs can only choose a functional output EX: Select PULSE output and then RELAY function no output and vice versa</p>

# CPM-10 MODBUS ADDRESS TABLE\*\*Address number are Hexadecima

Name	Modbus Address	Address	Range	Explain	Initial	Read/White
REtL	40001	0000h	0~9999999999	Active Energy (High word)		R
	40002	0001h		Active Energy (Mid word)		R
	40003	0002h		Active Energy (low word)		R
rEtL	40004	0003h	0~9999999999	Re-Active Energy (High word)		R
	40005	0004h		Re-active Energy (Mid word)		R
	40006	0005h		Re-active Energy (low word)		R
uRuG	40007	0006h	0~29999	Average Voltage		R
uRuG	40008	0007h	0~29999	Average Current		R
FrE9	40009	0008h	0~9999	Frequency		R
PtL	40010	0009h	-19999~29999	Total Active Power		R
9tL	40011	000Ah	-19999~29999	Total Re-active Power		R
StL	40012	000Bh	-19999~29999	Total Apparent Power		R
PF.RuG	40013	000Ch	-1000~1000	Average Power Factor		R
u-a	40014	000Dh	0~9999	Phase-A Voltage		R
u-b	40015	000Eh	0~9999	Phase-B Voltage		R
u-c	40016	000Fh	0~9999	Phase-C Voltage		R
i-a	40017	0010h	0~9999	Phase-A Current		R
i-b	40018	0011h	0~9999	Phase-B Current		R
i-c	40019	0012h	0~9999	Phase-C Current		R
PF-a	40020	0013h	-1000~1000	Phase-A Power Factor		R
PF-b	40021	0014h	-1000~1000	Phase-B Power Factor		R
PF-c	40022	0015h	-1000~1000	Phase-C Power Factor		R
P-a	40023	0016h	-1999~9999	Phase-A Active Power		R
P-b	40024	0017h	-1999~9999	Phase-B Active Power		R
P-c	40025	0018h	-1999~9999	Phase-C Active Power		R
9-a	40026	0019h	-1999~9999	Phase-A Re-active Power		R
9-b	40027	001Ah	-1999~9999	Phase-B Re-active Power		R
9-c	40028	001Bh	-1999~9999	Phase-C Re-active Power		R
S-a	40029	001Ch	0~9999	Phase-A Apparent Power		R
S-b	40030	001Dh	0~9999	Phase-B Apparent Power		R
S-c	40031	001Eh	0~9999	Phase-C Apparent Power		R
i-dP	40032	001Fh	0~2	DP of Current 0:0.000A 1:00.00A 2:000.0A		R
U-dP	40033	0020h	0~3	DP of Voltage 0:000.0V 1:0000V 2:00.00kV 3:000.0kV		R
W-dP	40034	0021h	0~6	DP of Active Power 0:0.1W 1:1W 2:0.01KW 3:0.1KW 4:1KW 5:0.01MW 6:0.1MW 7:1MW		R
W rE5	40035	0022h	0~3	Wiring of Voltage & Current Input 0: 1P2W 1: 1P3W 2: 3P3W.1 3: 3P3W.2 4:3P3W.3 5: 3P4W.1 6:3P4W.3	3	R/W
uUn it	40036	0023h	0~1	Unit for Primary Voltage of PT 0: V 1: kV	0	R/W
PtPr i	40037	0024h	500~29999	Primary Voltage of PT	3000	R/W
PtSEc	40038	0025h	500~5000	Secondary Voltage of PT	3000	R/W
ItPr i	40039	0026h	10~29999	Primary Current of CT	500	R/W
ItSEc	40040	0027h	1000/5000	Secondary Current of CT	5000	R
RuG-u	40041	0028h	2~99	Average Display for Voltage	5	R/W
RuG-i	40042	0029h	2~99	Average Display for Current	5	R/W
RuG-P	40043	002Ah	2~99	Average Display for Power	5	R/W
ELrSE	40044	002Bh	0~1	The Reset for Energy 0:No Clear values 1:Clear values	0	R/W
PcOdE	40045	002Ch	0000~9999	Pass Code	1000	R/W
FLoCk	40046	002Dh	0~3	Function Lock 0: none 1: User Level 2: Engineer Level 3: All	0	R/W
W-d u	40047	002Eh	0~1	Watt high-resolution 0: OFF(Normal) 1: ON(High)	0	R/W
LcUt	40048	002Fh	0~1000	Low Cut	2	R/W

# CPM-10 MODBUS ADDRESS TABLE\*\*Address number are Hexadecima

Name	Modbus Address	Address	Range	Explain	Initial	Read/White
r 115L	40050	0031H	0~24	The parameter relative to Relay 1.1 0: Average Voltage 1: Average Current 2: Frequency 3: Total Active Power 4: Total Re-active Power 5: Total Apparent Power 6: Average Power Factor 7: Phase-A Voltage 8: Phase-B Voltage 9: Phase-C Voltage 10: Phase-A Current 11: Phase-B Current 12: Phase-C Current 13: Phase-A Power Factor 14: Phase-B Power Factor 15: Phase-C Power Factor 16: Phase-A Active Power 17: Phase-B Active Power 18: Phase-C Active Power 19: Phase-A Re-active Power 20: Phase-B Re-active Power 21: Phase-C Re-active Power 22: Phase-A Apparent Power 23: Phase-B Apparent Power 24: Phase-C Apparent Power	0	R/W
r 115d	40051	0032H	0~5	Relay 1.1 Energized Mode 0: No Use 1: Low Energized 2: High Energized 3: Low Energized Hold 4: High Energized Hold 5: Digital Output	2	R/W
r 115P	40052	0033H	-19999~29999	Relay 1.1 Set Point	3000	R/W
r 125L	40053	0034H	0~24	The parameter relative to Relay 1.2 0: Average Voltage 1: Average Current 2: Frequency 3: Total Active Power 4: Total Re-active Power 5: Total Apparent Power 6: Average Power Factor 7: Phase-A Voltage 8: Phase-B Voltage 9: Phase-C Voltage 10: Phase-A Current 11: Phase-B Current 12: Phase-C Current 13: Phase-A Power Factor 14: Phase-B Power Factor 15: Phase-C Power Factor 16: Phase-A Active Power 17: Phase-B Active Power 18: Phase-C Active Power 19: Phase-A Re-active Power 20: Phase-B Re-active Power 21: Phase-C Re-active Power 22: Phase-A Apparent Power 23: Phase-B Apparent Power 24: Phase-C Apparent Power	1	R/W
r 125d	40054	0035H	0~5	Relay 1.2 Energized Mode 0: No Use 1: Low Energized 2: High Energized 3: Low Energized Hold 4: High Energized Hold 5: Digital Output	2	R/W
r 125P	40055	0036H	-19999~29999	Relay 1.2 Set Point	5000	R/W
r 135L	40056	0037H	0~24	The parameter relative to Relay 1.3 0: Average Voltage 1: Average Current 2: Frequency 3: Total Active Power 4: Total Re-active Power 5: Total Apparent Power 6: Average Power Factor 7: Phase-A Voltage 8: Phase-B Voltage 9: Phase-C Voltage 10: Phase-A Current 11: Phase-B Current 12: Phase-C Current 13: Phase-A Power Factor 14: Phase-B Power Factor 15: Phase-C Power Factor 16: Phase-A Active Power 17: Phase-B Active Power 18: Phase-C Active Power 19: Phase-A Re-active Power 20: Phase-B Re-active Power 21: Phase-C Re-active Power 22: Phase-A Apparent Power 23: Phase-B Apparent Power 24: Phase-C Apparent Power	3	R/W
r 135d	40057	0038H	0~5	Relay 1.3 Energized Mode 0: No Use 1: Low Energized 2: High Energized 3: Low Energized Hold 4: High Energized Hold 5: Digital Output	2	R/W
r 135P	40058	0039H	-19999~29999	Relay 1.3 Set Point	4500	R/W
r 115b	40059	003AH	0~9999	Start Band of input for Relay1.1 energized	0	R/W
r 115d	40060	003BH	0~5999 (0.1second)	Start Delay Time of input for Relay1.1 energized	0	R/W
r 115H	40061	003CH	0~5000	Hysteresis of Relay 1.1	0	R/W
r 115r	40062	003DH	0~5999 (0.1second)	Energized Delay Time of Relay 1 1	0	R/W
r 115F	40063	003EH	0~5999 (0.1second)	De-Energized Delay Time of Relay 1.1	0	R/W
r 125b	40064	003FH	0~9999	Start Band of input for Relay1.2 energized	0	R/W
r 125d	40065	0040H	0~5999 (0.1second)	Start Delay Time of input for Relay1.2 energized	0	R/W
r 125H	40066	0041H	0~5000	Hysteresis of Relay 1.2	0	R/W
r 125r	40067	0042H	0~5999 (0.1second)	Energized Delay Time of Relay 1.2	0	R/W
r 125F	40068	0043H	0~5999 (0.1second)	De-Energized Delay Time of Relay 1.2	0	R/W
r 135b	40069	0044H	0~9999	Start Band of input for Relay1.3 energized	0	R/W
r 135d	40070	0045H	0~5999 (0.1second)	Start Delay Time of input for Relay1.3 energized	0	R/W
r 135H	40071	0046H	0~5000	Hysteresis of Relay 1.3	0	R/W
r 135r	40072	0047H	0~5999 (0.1second)	Energized Delay Time of Relay 1.3	0	R/W
r 135F	40073	0048H	0~5999 (0.1second)	De-Energized Delay Time of Relay 1.3	0	R/W
Relay Status	40074	0049H	0~7	bit0~bit2: Relay1.1~Relay1.3; 0=Relay off 1=Relay on	0	R/W

# CPM-10 MODBUS ADDRESS TABLE\*\*Address number are Hexadecima

Name	Modbus Address	Address	Range	Explain	Initial	Read/White
R <sub>o</sub> .S <sub>L</sub>	40078	004DH	0~24	The parameter relative to Analog Output 1 0: Average Voltage 1: Average Current 2: Frequency 3: Total Active Power 4: Total Re-active Power 5: Total Apparent Power 6: Average Power Factor 7: Phase-A Voltage 8: Phase-B Voltage 9: Phase-C Voltage 10: Phase-A Current 11: Phase-B Current 12: Phase-C Current 13: Phase-A Power Factor 14: Phase-B Power Factor 15: Phase-C Power Factor 16: Phase-A Active Power 17: Phase-B Active Power 18: Phase-C Active Power 19: Phase-A Re-active Power 20: Phase-B Re-active Power 21: Phase-C Re-active Power 22: Phase-A Apparent Power 23: Phase-B Apparent Power 24: Phase-C Apparent Power	0	R/W
R <sub>o</sub> .T <sub>P</sub>	40079	004EH	0~13	Analog Output 1 Type 0: V.0-5 1: V.1-5 2: V.0-10 3: V.0.b.5 4: V.1.b.5 5:V.0.b.10 6: V.b.5 7: V.b.10 8: A.0-10 9: A.0-20 10: A.4-20 11: A.4.b.20 12: A.b.10 13: A.b.20	10	R/W
R <sub>o</sub> .L <sub>S</sub>	40080	004FH	-19999~29999	Analog Output 1 Low scale	0	R/W
R <sub>o</sub> .H <sub>S</sub>	40081	0050H	-19999~29999	Analog Output 1 High scale	3000	R/W
R <sub>o</sub> .P <sub>o</sub>	40082	0051H	-32168~32767	Analog Output Zero adjustment	0	R/W
R <sub>o</sub> .S <sub>n</sub>	40083	0052H	-32168~32767	Analog Output Span adjustment	0	R/W
P <sub>S</sub> .C <sub>L</sub> r	40084	0053H	0~3	The clear of Analog Output Zero and Span	0	R/W
R <sub>o</sub> .L <sub>t</sub>	40085	0054H	0~11000	Analog Output High Limit	1100	R/W

Name	Modbus Address	Address	Range	Explain	Initial	Read/White
R <sub>d</sub> .E <sub>S</sub>	40113	0070H	1~255	RS485 address	1	R/W
b <sub>R</sub> U <sub>d</sub>	40114	0071H	0~5	RS485 baud rate 0: 1200 1: 2400 2: 4800 3: 9600 4: 19200 5: 38400	3	R/W
P <sub>r</sub> .E <sub>Y</sub>	40115	0072H	0~3	RS485 parity 0: n-8-1 1: n-8-2 2: odd 3: even	1	R/W

Name	Modbus Address	Address	Range	Explain	Initial	Read/White
P <sub>L</sub> .S <sub>d</sub> u	40125	007CH	1~9999	Pulse Divider	1	R/W
P <sub>L</sub> .S <sub>H</sub> i	40126	007DH	0~5000	The Period of Pulse Output High 0(Auto)/~1~5000*4mSec	0	R/W