



INSTRUCTION MANUAL

ENGLISH



CAPO 2.5

Capacitance and Power Factor Meter



Contents

1	Notice of copyright & proprietary rights.....	5
2	Safety.....	6
2.1	Safety Precautions.....	7
3	Unpacking.....	9
4	Power factor / $\tan \delta$ measurements.....	11
4.1	Definitions.....	11
4.1.1	Dissipation factor $\tan \delta$	12
4.1.2	Power Factor (PF) $\cos \varphi$	12
4.2	Background.....	13
4.2.1	Imperfect dielectric.....	13
4.2.2	Conversion series- parallel-replacement circuit diagram.....	15
4.2.2.1	Simplifications for small Dissipation / Power Factor.....	18
4.2.3	Conversion capacitances to inductances.....	19
5	Introduction.....	20
5.1	General.....	20
5.2	Advantages & Features.....	22
5.3	System Details.....	22
6	Quick Start Guide.....	23
6.1	Connection.....	23
6.2	Instrument operation.....	23
7	Operation Elements.....	24
8	Operating Menu.....	27
8.1	Menu Structure.....	27
8.2	Main Menu.....	28
8.2.1	Main Menu Screen.....	28
8.2.1.1	Safety-Switch.....	30
8.2.1.2	Earth connection.....	30
8.2.1.3	Battery Symbol.....	31
8.2.1.4	Test object.....	31
8.2.1.5	Time.....	32
8.2.2	Measurement Mode.....	32
8.2.3	Caption.....	33
8.2.4	Measurement frequency.....	34
8.2.5	Measurement voltage.....	36
8.2.6	Start a measurement.....	37
8.2.6.1	Single measurement.....	37
8.2.6.2	Continuous measurement.....	38
8.2.7	Setup.....	40
8.2.7.1	General.....	41
8.2.7.1.1	License.....	41
8.2.7.1.2	About.....	42
8.2.7.1.3	Clock.....	42



8.2.7.1.4	Cursor.....	42
8.2.7.1.5	Update.....	43
8.2.7.1.6	Language.....	43
8.2.7.1.7	Service.....	44
8.2.7.2	Operator.....	44
8.2.7.3	Oil Correction Table.....	45
8.2.7.4	Dissipation factor.....	45
8.2.7.5	Quality Assistant.....	46
8.2.7.6	Printer.....	47
8.2.7.7	Color.....	48
8.3	Results and data structure.....	49
8.3.1	New.....	49
8.3.1.1	New test object.....	50
8.3.1.2	Load from Archive.....	51
8.3.1.3	New Measurement.....	51
8.3.2	Info.....	52
8.3.3	Archive.....	53
8.3.3.1	Info.....	53
9	Measurement Modes.....	55
9.1	Overview.....	55
9.2	UST Ungrounded Specimen Test.....	56
9.2.1	UST A.....	57
9.2.2	UST B.....	57
9.2.3	UST A + B.....	58
9.3	GST.....	59
9.3.1	GST A + B.....	59
9.4	GSTg.....	60
9.4.1	GSTg A.....	61
9.4.2	GSTg B.....	61
9.4.3	GSTg A + B.....	62
10	Technical Specifications.....	63
10.1	Measurement Parameters.....	64
10.2	Features.....	65
11	Interfaces.....	66
11.1	Hardware.....	66
11.1.1	RS 323.....	66
11.1.2	USB.....	66
11.1.3	Safety.....	67
11.1.4	Temp.....	68



Appendix

A Software Development Kit (SDK).....	71
B Command Syntax.....	72
B.1 Raytech USB/Serial Port Driver.....	72
B.2 Command Syntax.....	72
B.3 Answercodes.....	72
B.3.1 Synchronus Answers.....	72
B.3.2 Asynchronuous Answer.....	73
B.4 Serial Interface.....	73
B.5 USB Interface.....	73
C Service Mode.....	74
C.1 Calibrate Touchscreen.....	74
C.2 Show Ground Warning.....	75
C.3 CSV Separator.....	76
C.4 Raytech USB Driver.....	76
C.5 Oil Correction Table.....	77
D USB Printer Info.....	79
E Error Messages.....	80
F Trouble Shooting.....	81
F.1 Test Voltage cannot be turned on.....	81
F.2 Touch Panel does not work.....	82
F.3 USB Memory Stick does not work.....	82
F.4 Cannot switch off the CAPO.....	82
G Warranty Conditions.....	83
H Contacts.....	85



1 Notice of copyright & proprietary rights

© 2017, Raytech GmbH. All rights reserved.

The contents of this manual are the property of Raytech GmbH. No part of this work may be reproduced or transmitted in any form or by any means, except as permitted in written license agreement with Raytech GmbH. Raytech GmbH has made every reasonable attempt to ensure the completeness and accuracy of this document. However, the information contained in this manual is subject to change without notice, and does not represent a commitment on the part of Raytech GmbH. Any attached hardware schematics and technical descriptions, or software listings that disclose source code, are for informational purposes only. Reproduction in whole or in part to create working hardware or software for other than Raytech GmbH products is strictly prohibited, except as permitted by written license agreement with Raytech GmbH.



2 Safety

Before performing any test with this instrument, read this user manual and observe all safety precautions indicated.



WARNING!

Hazardous voltage may result in severe injury or death!

Be aware that Safety is the responsibility of the user!

Corrective maintenance must be performed by qualified personnel who are familiar with the construction and operation of the test set and the hazards involved.

Raytech GmbH refuses to accept any responsibility for consequential or direct damage to persons or goods due to non-observance of instructions contained herein or due to incorrect use of the instrument.

The FIRST cable you have to connect and lead to earth ground is always the Safety GND. This is also the LAST cable to disconnect! Any interruption of the grounding connection can create an electric shock hazard.

Never disconnect the high voltage or the low voltage test cables from either the terminals of the test specimen or the instrumental side, unless the CAPO is in safe mode.

The CAPO and the specimen to which it is connected are possible sources of high voltage electrical energy and all persons making or assisting in tests must use all practical safety precautions to prevent contact with energized parts of the test set and related circuits. Persons actually engaged in the test must stand clear of all parts of the complete high voltage circuit, including all connections, unless the test set is deenergized and all parts of the test circuit are grounded.



WARNING!

Before operating the instrument, be sure to read and understand fully the operating instructions. This instrument is connected to hazardous voltages. It is the responsibility of the user to ensure that the system is operated in a safe manner.

Refer to IEEE 510 - 1983, "IEEE Recommended Practices for Safety in High-Voltage and High-Power Testing," for information.



2.1 Safety Precautions

The following safety precautions must be observed during all phases of operation, service and repair of this instrument. By purchasing this equipment the purchaser assumes all liability for the operation and use of this equipment. The intended use of the instrument, its design and manufacture, is to be conducted within the precautions or other specific warnings located within this manual. Failure to comply with these precautions and other specific warnings violates safety standards of design, manufacture, and intended use. Raytech Switzerland assumes no liability for the operation and use of this equipment.

SAFE OPERATION

Only qualified, knowledgeable persons should be permitted or attempt to operate this test equipment. All test personnel should fully familiarize themselves with the correct application and operation of this and all test equipment prior to operation. Persons directly and indirectly engaged in the operation of this test equipment should keep clear of all high voltage apparatus while conducting tests and measurements.



WARNING!

Never connect the instrument to an energized transformer!

GROUND THE INSTRUMENT



WARNING!

The **FIRST** cable you have to connect and lead to earth ground is always the Safety GND. This is also the **LAST** cable to disconnect! Any interruption of the grounding connection can create an electric shock hazard.

To minimize shock hazard, the Ground Terminal on the instrument must be properly connected to an Earth grounded point. In many cases, the quality of the safety ground terminal provided by the power cord does not fulfil the safety requirements.

Non-grounded instruments are dangerous and may cause Personnel and instrument damage.

BEFORE APPLYING POWER

Read this manual carefully before operating the system. The CAPO 2.5 is battery and line operated. It operates from a wide range power input from 85 to 264Vac and 47...63Hz with automatic ranging.



KEEP AWAY FROM LIVE CIRCUITS

Operating personnel must not remove instrument covers. Component replacement and internal repairs must be made by qualified service personnel. Do not replace components or service this instrument with the power cable connected. To avoid injuries, always discharge circuits, disconnect power and remove external voltage sources before touching components.

DO NOT OPERATE IN AN EXPLOSIVE ATMOSPHERE

Do not operate the instrument in the presence of flammable gases or fumes.

DO NOT SUBSTITUTE PARTS OR MODIFY INSTRUMENT

Because of the danger of introducing additional hazards, do not install substitute parts or perform any unauthorized modification to the instrument. Return the instrument to a Raytech service department for service to ensure proper operation and that safety features are maintained.

Instruments, which appear damaged or defective, should be made inoperative and secured against unintended operation until they can be repaired by qualified service personnel.



3 Unpacking

The CAPO 2.5 consists of the following items:



The Instrument



Power cord (dependent upon country of distribution)



2 Paper Rolls



HV Cable
1 x 10m



Measurement Cables
2 x 10m



Cable bag



Safety-GND Cable
1 x 10m



HV-GND Cables
1 x 10m



Safety-Switch
1 x 2m

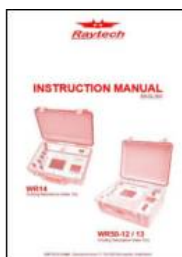

Instruction Manual



USB Memory Stick



If any of the above items are missing or damaged, contact your local representative or Raytech Switzerland immediately.

Optional test leads may be ordered (other than shown).



4 Power factor / $\tan \delta$ measurements¹

4.1 Definitions

IEC defines the power factor $\cos \varphi$ as the ratio between the absorbed active power to the absolute value of the reactive power. This corresponds to $\tan \delta$.

Definition of dielectric variables $\tan \delta$ (dissipation factor) and $\cos \varphi$ (insulation power factor)

Example: Equivalent parallel circuit

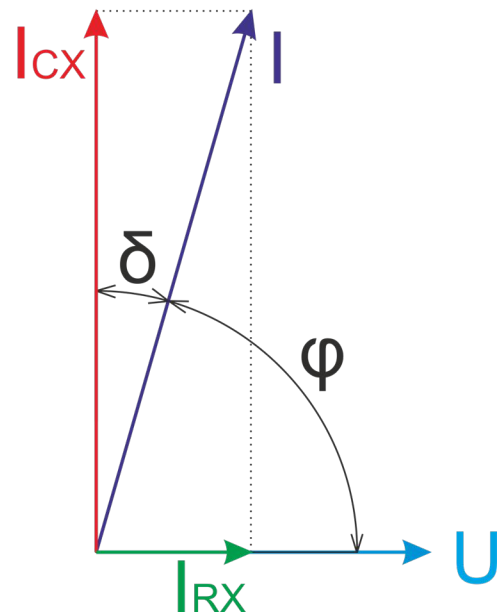
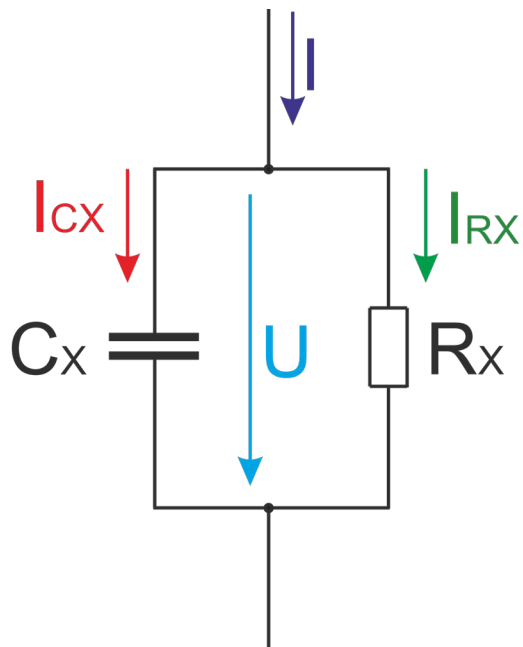

¹ According to IEEE Std C57.152-2013



4.1.1 Dissipation factor $\tan \delta$

It is the tangent of its loss angle δ

$$\tan \delta = \frac{P}{|Q|}$$

$$\tan \delta = \frac{P}{|Q|} = \frac{I_{RX}}{I_{CX}} = \frac{\sin \delta}{\sqrt{1 - \sin^2 \delta}}$$

where:

P Real Power [W]

I_{RX} current through resistance [A]

Q Reactive Power [var]

I_{CX} current through capacitance [A]

4.1.2 Power Factor (PF) $\cos \varphi$

It is the Cosine of the phase angle φ or the sine of the loss angle δ

$$PF = \cos \varphi = \frac{P}{S}$$

$$\cos \varphi = \frac{P}{S} = \frac{P}{\sqrt{P^2 + Q^2}} = \frac{I_{RX}}{I} = \sin \delta = \frac{I_{RX}}{\sqrt{I_{RX}^2 + I_{CX}^2}} = \frac{\tan \delta}{\sqrt{1 + \tan^2 \delta}}$$

where:

P Real Power [W]

I_{RX} current through resistance [A]

S Apparent Power [VA]

I_{CX} current through capacitance [A]

I total current [A]



The CAPO is able to display either dissipation factor $\tan \delta$ or power factor $\cos \varphi$ based on the users choice.²

In cases where the angle is very small, dissipation factor $\tan \delta$ practically equals power factor $\cos \varphi$.

Have a look at chapter 4.2.2.1 Simplifications for small Dissipation / Power Factor on page 18.

4.2 Background

Insulation power factor (PF) is one of the most common tests performed on transformers, regulators, reactors, bushings, and other support equipment and should be conducted as part of factory, acceptance, and routine assessment. Though dielectrics have inherent losses due to construction materials, PF measurement is most effective at detecting the relative levels of moisture and contamination. Evaluation of the capacitance measurement is effective in detecting physical defects that lead to changes in the dielectric's geometry.

4.2.1 Imperfect dielectric

The properties of true dielectric insulations are often simplified and expressed as imperfect dielectrics. An imperfect dielectric is a dielectric where the energy necessary to create an electric field is not returned to the electric field when the energy is removed. The energy is converted into heat in the dielectric. Conversely, a perfect dielectric has zero conductivity, and there are no absorption effects. A high vacuum is an example of a perfect dielectric. Most dielectrics tested are considered imperfect dielectrics due to the presence of moisture, contaminants, and other inherent polar molecules.

² On the main screen you can tick on it to change from $\tan \delta$ to PF. For more information have a look at chapter 8.2.7.4 Dissipation factor on page 45.



The two common methods of representing the imperfect dielectric are the series and parallel circuit. These two circuits include two elements, a capacitor and a resistor.

The resistor represents the loss component of the insulation, while the capacitor represents the geometric and physical properties, such as the dielectric constant.

The figure below displays the two common methods of representing the imperfect dielectric.

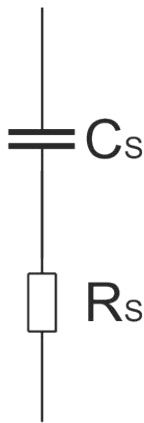

Serial Circuit

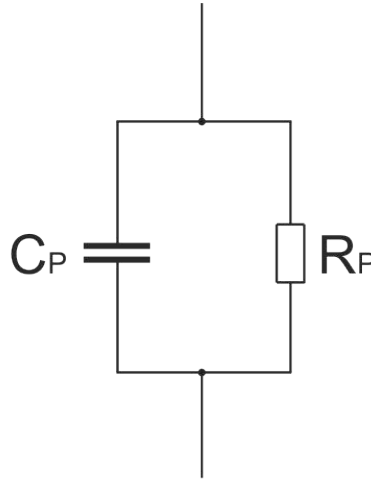

Parallel Circuit

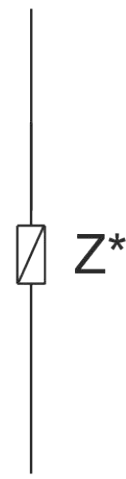

Impedance
*complex

$$R_S + \frac{1}{j\omega C_S} = \frac{R_P \frac{1}{j\omega C_P}}{R_P + \frac{1}{j\omega C_P}} = Z$$

where:

C _s	serial Capacitance [F]	R _p	parallel Resistance [Ω]
C _p	parallel Capacitance [F]	Z	Impedance (complex) [Ω]
R _s	serial Resistance [Ω]	ω	angular frequency [s ⁻¹] ω=2*π*f

Either circuit is adequate for explaining the effects of PF within a dielectric specimen. In the series circuit, R_s represent the series ac resistance. The parallel circuit shows R_p as the equivalent parallel resistance. Though both can be used in discussing and defining PF, the **parallel circuit** is the most common. In both cases, the resistance represents the presence of moisture, contaminants, lossy partial discharge (PD) activity, and inherent polar materials.

The CAPO 2.5 use the parallel circuit as model.



4.2.2 Conversion series- parallel-replacement circuit diagram

The following formulas are helpful for the conversion of the two models:

$$C_s = C_p * (1 + \tan^2 \delta)$$

$$C_p = \frac{C_s}{1 + \tan^2 \delta}$$

$$C_s = \frac{R_p^2 * \omega^2 * C_p^2 - 1}{R_p^2 * \omega^2 * C_p} = C_p * (1 + \tan^2 \delta)$$

$$C_p = \sqrt{\frac{R_p - R_s}{R_s * R_p^2 * \omega^2}} = \frac{C_s}{1 + \tan^2 \delta}$$

$$R_s = \frac{|Z^2|}{R_p} = \frac{R_p * X_p^2}{R_p^2 + X_p^2} = \frac{R_p}{R_p^2 * \omega^2 * C_p^2 + 1} = \frac{R_p * \tan^2 \delta}{1 + \tan^2 \delta} = \frac{\tan \delta}{\omega * C_s}$$

$$R_p = \frac{|Z^2|}{R_s} = \sqrt{\frac{X_p^2 * X_s}{X_p - X_s}} = \frac{1}{\omega * C_p * \tan \delta}$$

$$Z = X_s * \sqrt{1 + \tan^2 \delta}$$

$$R_p * R_s = |Z^2|$$

$$\tan \delta_{\text{serial}} = \tan \delta_{\text{parallel}}$$

$$Z_p = Z_s = Z$$

where:

C _s	serial Capacitance [F]	Z _s	serial Impedance [Ω]
C _p	parallel Capacitance [F]	Z _p	parallel Impedance [Ω]
R _s	serial Resistance [Ω]	X _s	serial Reactance [Ω]
R _p	parallel Resistance [Ω]	X _p	parallel Reactance [Ω]
Z	Impedance [Ω]	ω	angular frequency [s ⁻¹] ω=2*π*f



$$X_s = \frac{R_p^2 * X_p}{R_p^2 + X_p^2}$$

$$X_s = \frac{R_p^2 * \omega * C_p}{1 - R_p^2 * \omega^2 * C_p^2}$$

$$X_p = \sqrt{\frac{R_p^2 * R_s}{R_p - R_s}}$$

where:

- Cs serial Capacitance [F]
- Cp parallel Capacitance [F]
- Rs serial Resistance [Ω]
- Rp parallel Resistance [Ω]
- ω angular frequency [s^{-1}] $\omega=2*\pi*f$
- Xs serial reactance [Ω]
- Xp parallel reactance [Ω]





4.2.2.1 Simplifications for small Dissipation / Power Factor

If the dissipation / power factor is small, the error can be neglected and you can use the following simplifications:

$$C_s \approx C_p$$

$$Z \approx X_s \approx X_p$$

$$R_s \approx X_s * \tan \delta$$

$$R_p \approx \frac{X_p}{\tan \delta}$$

$$Error \approx 1 + \tan^2 \delta$$

For $\tan \delta < 3\%$, the difference between PF and $\tan \delta$ is smaller than 0.1%

where:

Cs	serial Capacitance [F]	Xp	parallel Reactance [Ω]
Cp	parallel Capacitance [F]	Rs	serial Resistance [Ω]
Z	Impedance [Ω]	Rp	parallel Resistance [Ω]
Xs	serial Reactance [Ω]		



4.2.3 Conversion capacitances to inductances³

The CAPO is able to measure the inductance. With the formulas below you can make the conversion. On the main screen of the CAPO, just tick on the result Cx and it will switch to Lx (the tan δ /PF will switch to Quality factor).

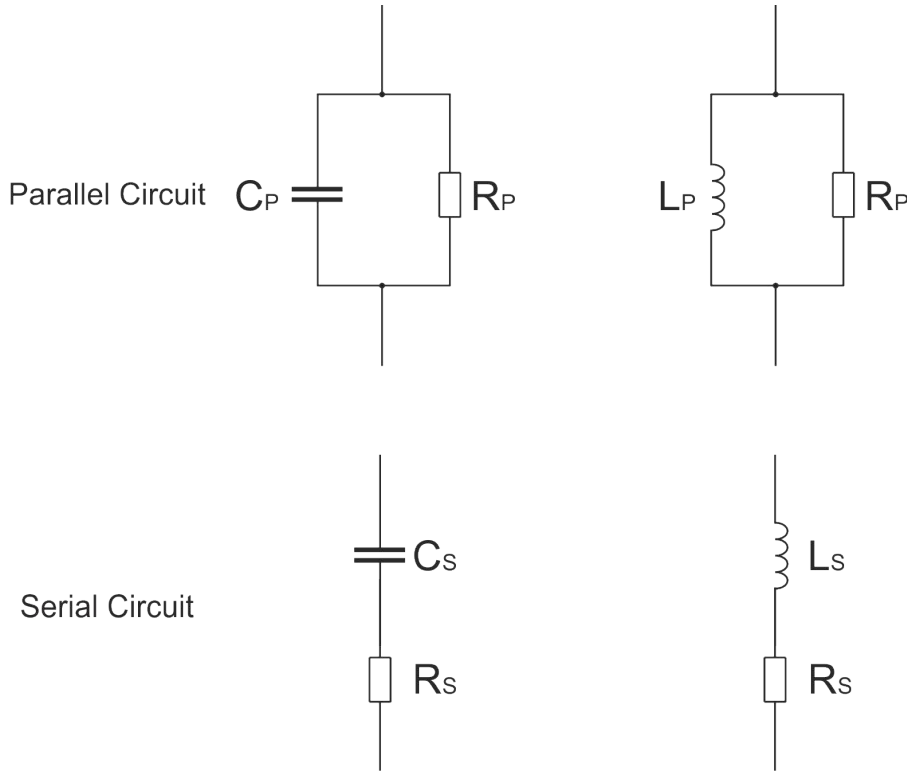

$$Z = \frac{1}{j\omega Cs} + Rs = j\omega Ls + Rs$$

$$Rs = Rs$$

$$\frac{1}{j\omega Cs} = j\omega Ls \Rightarrow 1 = -\omega^2 Ls Cs$$

$$L = \frac{-1}{\omega^2 * C}$$

$$Q = \frac{1}{\tan \delta_C}$$

where:

- | | | | |
|---|-----------------|-----------------|---|
| L | Inductances [H] | ω | angular frequency [s ⁻¹] $\omega=2*\pi*f$ |
| C | Capacitance [F] | Q | Quality factor |
| R | Resistance | $\tan \delta_C$ | Dissipation factor |

³ It is necessary to distinguish between serial and parallel (Lp, Ls and Cp, Cs)



5 Introduction

5.1 General

The measuring instrument CAPO 2.5 is a new Capacitance and Power Factor Test Set developed by Raytech Engineers. It is a unique, battery-operated instrument, built into a portable rugged case, making it perfect for field use. The CAPO 2.5 is specially designed for fast and easy field measurement, with the well known high precision and quality of Raytech.

This battery-operated test set measures dissipation factor ($\tan \delta$), power factor ($\cos \varphi$), capacitance, inductance, quality factor, and power (watts) which can be converted to 10kV. Built to stand up to the harsh conditions of field testing, this instrument provides reliable test results in any situation.

Ease of use: This intelligent system has an easy to use operation screen which allows quick selection of the current level to be measured. This system incorporates a touchscreen which allows the user easy access to change or activate a feature.

Impressive Accuracy: The instrument has a high precision, fully automatic, multi-microprocessor based architecture. This system is designed for highly accurate readings on-site with laboratory precision.

Built in Standard Capacitor: No external Capacitor is necessary to do precision measurement.

Battery operated: Practical field measurement system since no AC mains power is required.

Wide range: The frequency and the voltage is user selectable from 10Hz to 400Hz, up to 2500V. Results are reported on the easy-to-read color LCD display and can be stored or printed.

Compact Design: The CAPO 2.5 is available in its own rugged waterproof field case.



NOTE:

The CAPO case is a waterproof design. A pressure regulator activates when the case is opened to compensate for atmospheric pressure changes.

Simple Maintenance: There is no maintenance required. There is no calibration procedure (no potentiometers to turn). This is due to the utilization of high precision components in the design.



Advanced Protection: Upon powering on, the system initializes itself with a self-calibrating, circuit checking sequence. If any problems are detected during this initialization period, or during operation, the operator is immediately notified. The system constantly monitors the condition when turned on. This is one of the many reasons we can extend our warranty to 2 years.



5.2 Advantages & Features

- Battery operated, world unique
- Built-in Standard Capacitor
- Power Factor / Tan δ reading
- Test Frequency 10Hz to 400Hz
- Internal thermal printer
- Microprocessor based system with internal storage for over 10000 test results
- Data exchange via USB.Key or USB / RS232 Connection
- Storage and Printing of test results
- Complete automatic calibration system and system diagnostics
- Temperature channel
- Standard USB 2.0 & RS232 (serial) Interface
- Color LCD with backlighting and touch screen
- Pannel mounted Emergency Stop Switch
- Mounted in rugged case for field testing
- 2 Year standard warranty

5.3 System Details

System Check:

The instrument is battery and line operated. The system is designed to be used with AC Voltage power sources between 85 to 264VAC 47...63Hz. The CAPO performs a self-check each time that it is powered on. The User should always visually inspect all connectors, cables and devices to be measured to avoid any safety issues.



6 Quick Start Guide

6.1 Connection

The FIRST cable you have to connect and lead to earth ground is always the Safety GND!
Afterwards connect the HV-GND, the HV-cable and the measurement cable to the test object.
Finally, connect the Safety-Switch to the Instrument.

6.2 Instrument operation



WARNING!

Hazardous voltage may result in severe injury or death!

Before performing any test with this instrument, read this user manual and observe all safety precautions indicated. Especially read the chapter Safety on page 6.

1. Power on the instrument

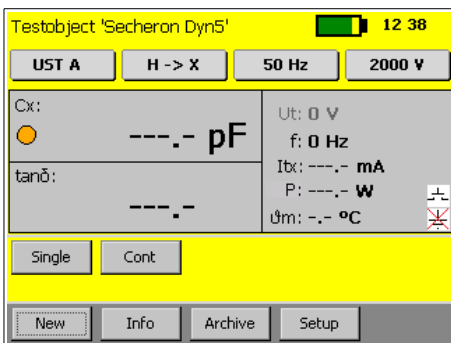

2. Select voltage and frequency

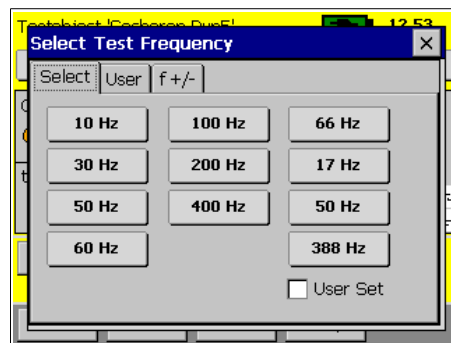

3. Press the Safety-Switch and select Single or Continuous to Start

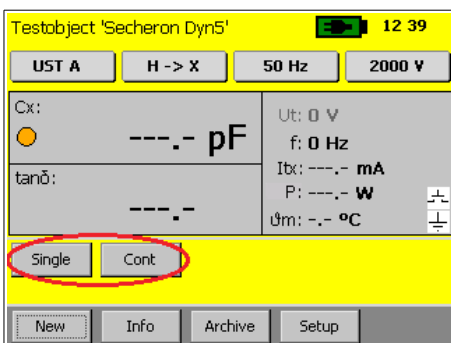

4. Get the results you want by selecting the measurement mode (during the measurement)

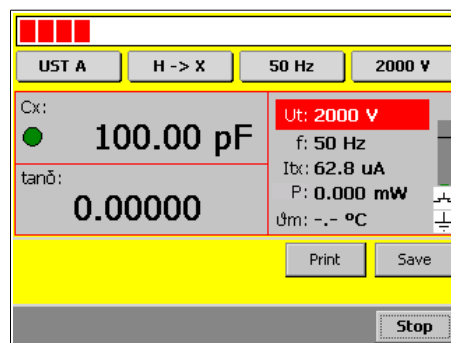



7 Operation Elements

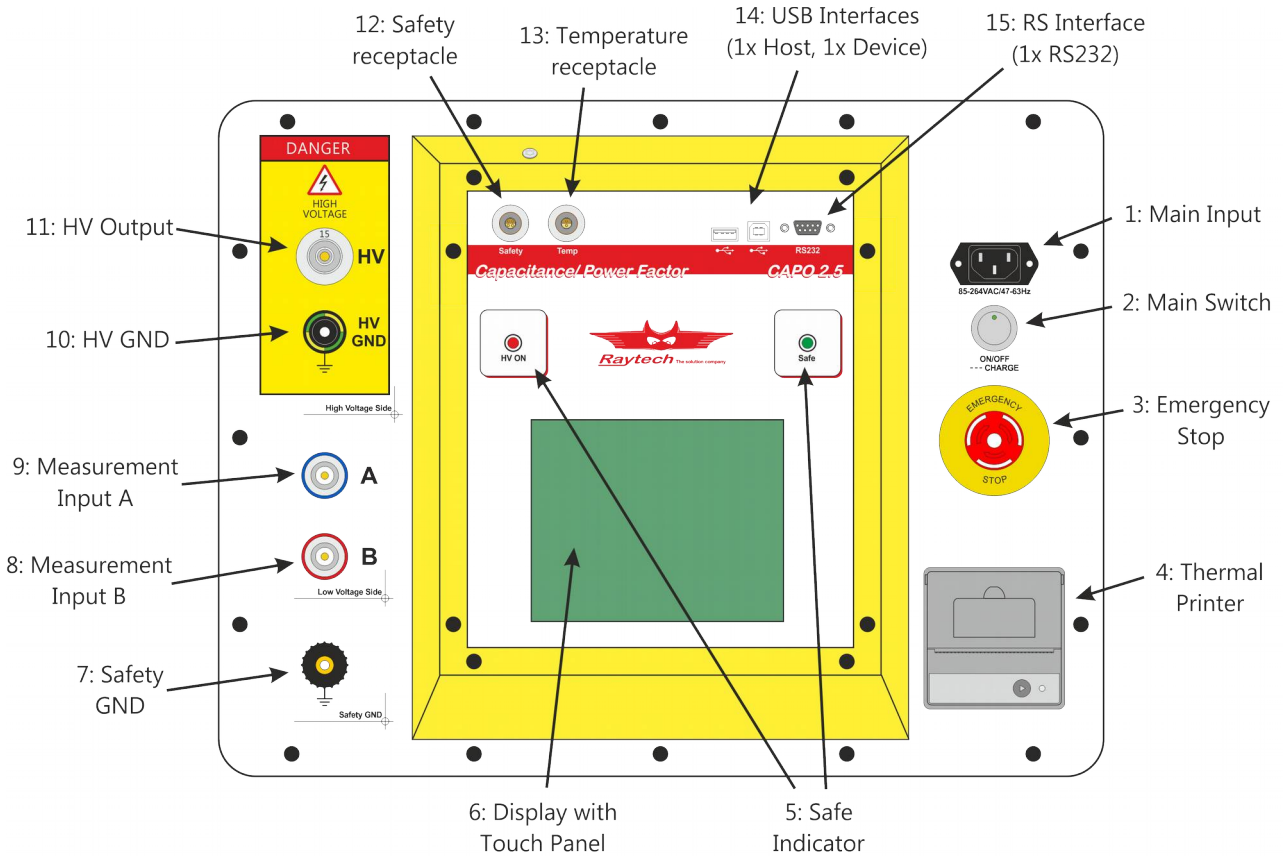

1: Main Input

Connect the power cable to the Main Input.

Press the Main Switch to switch the CAPO on / off.

2: Main Switch

Press to power the CAPO on / off.

3: Emergency Stop

Press to stop: The measurement will stop and immediately switch off the high voltage.

Turn clockwise to release. The device will remain in a safe mode state.



4: Thermal Printer

Allows you to quickly get your results on paper by using the built-in thermal printer.

5: Safety Indicator

Green Light on: System is in safe mode. Ready for handling test leads, connections.

Red Light on: Unsafe mode! Don't remove any cables and don't touch the test object.



WARNING!

High voltage is on!

6: Display with Touch Panel

The instrument can be easily manipulated and fully controlled by the touch screen panel. If preferred, an external mouse or keyboard can be connected to the USB Port to control the system.

7: Safety GND

Connect a proper earth.

The FIRST cable you have to connect and lead to earth ground is always the Safety GND. This is also the LAST cable to disconnect! Any interruption of the grounding connection can create an electric shock hazard.

8: Measurement Input B

Connect the red measurement cable to this input.

9: Measurement Input A

Connect the blue measurement cable to this input.

10: HV GND

This is also a measurement Input. Connect the green-yellow cable to this input.

11: HV Output

This is the receptacle for the high voltage. Connect the orange high voltage cable to this input.



12: Safety receptacle

Here you can connect the Safety-Switch.

For more detail about this receptacle have a look in the chapter 11.1.3 Safety on page 67.

13: Temperature receptacle

This receptacle is for an external temperature probe.

(Optional Accessory TP01)

14: USB Interface

1 x USB Host

1 x USB Device

See chapter 11.1.2 USB on page 66 for details.

15: RS Interface

RS232

See chapter 11.1.1 RS 323 on page 66 for details.



8 Operating Menu

The instrument software is straight forward and easy to set up and operate. With a few key strokes and selections on the test screen, measurements can be started. See chapter 6 Quick Start Guide on page 23.

8.1 Menu Structure

CAPO 2.5 menu structured as shown in the figure below.

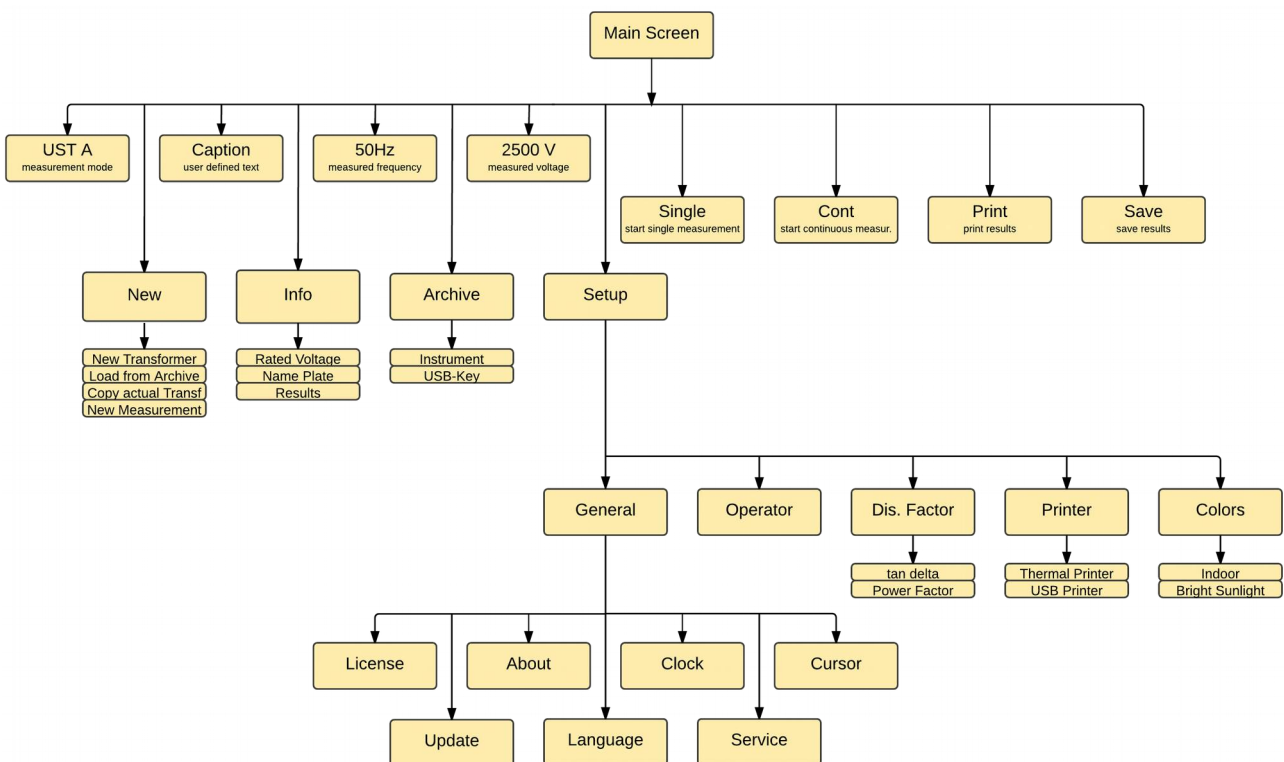



8.2 Main Menu

8.2.1 Main Menu Screen

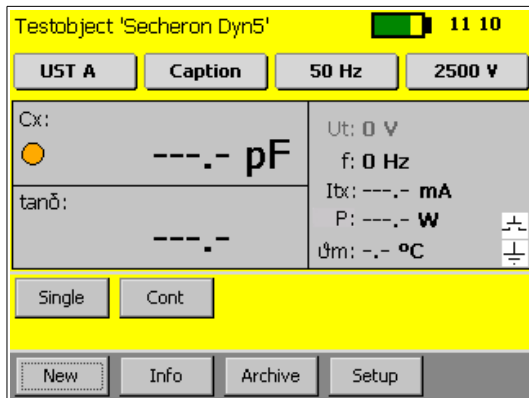

The Touch screen enables quick navigation by pressing directly on the screen. e.g. if you would like to change the measurement voltage, press on it and the Menu “Select Test Voltage” will open.

UST A

Select the measurement Mode.
For more information see chapter 9 Measurement Modes on the page 55.

Caption

User defined Caption for the measurement result.

50 Hz

Select the measurement test frequency.

2500 V

Select the measurement voltage.

Cx:

Shows the measurement result. You can tick on it to change from capacitance [Farad] to Inductance [Henry].

tanδ:

Shows the measurement result. You can tick on it to change from tan δ to PF (Power Factor) [%]. If you have selected inductance in the upper field, you will see here Q (Quality).



Ut:

Measurement test voltage [V].

f:

Measurement frequency [Hz].

Itx:

Measurement current [A] through test object (depending on measurement mode).

P:

Power [W] over test object.

If you click on it, it will change to **P_{10k}**: Then it shows the Power [W] @ 10kV. This is the calculated power you would have, when you had 10kV over this test object.

∅m:

If you connect a temperature probe (TP01), you will see the measured temperature.

If the receptacle "Temp" is open, you can click on ∅m: and enter the temperature manually.

Single

Starts a single measurement.

Cont

Starts a continuous measurement.

Print

Prints the measured result.

Save

Saves the measured results.

New

Opens the menu for a new transformer template or a new measurement.

Info

Opens the menu for the information about the results or the actual transformer template.



Archive

Opens the menu with the stored results and transformer templates on the instrument and the USB-key, if you have one connected.

Setup

Opens the Setup menu.

8.2.1.1 Safety-Switch

On the right side of the main screen is a symbol for the Safety-Switch.

Safety-Switch is open

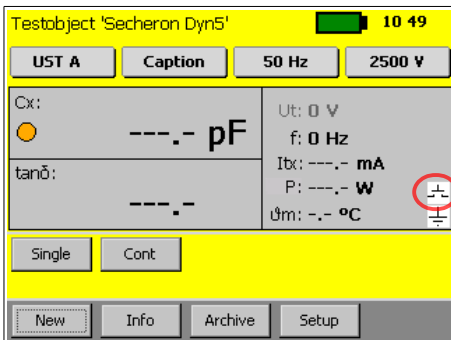

Safety-Switch is pressed

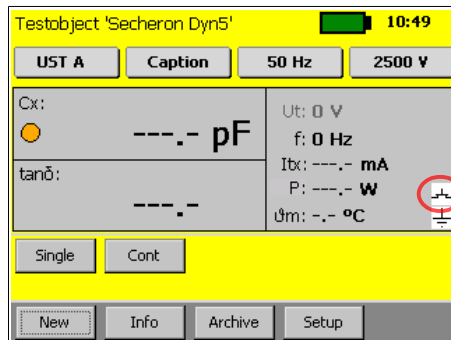

8.2.1.2 Earth connection

Below the symbol for the Safety-Switch there is the symbol for the earth connection.

If the symbol is crossed, the earth connection is open

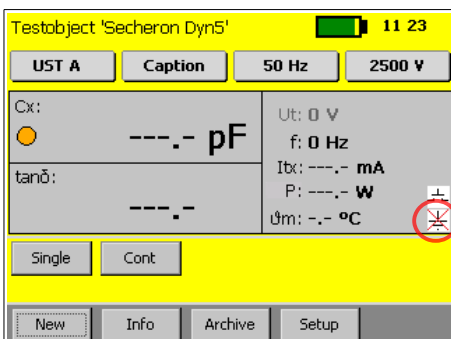

Earth connection is done

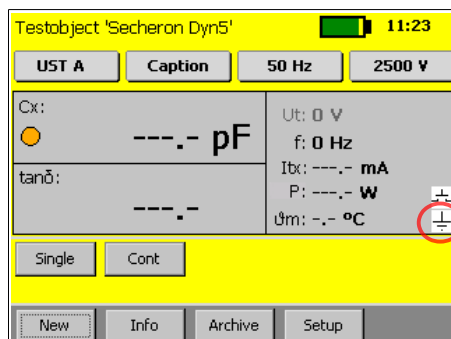



8.2.1.3 Battery Symbol

The battery symbol indicates the level of the battery and if the mains are connected or not.

Mains operation and charging.
A plug symbol is in the Battery.

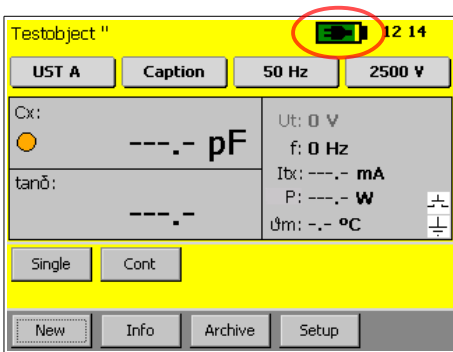

Battery operation.

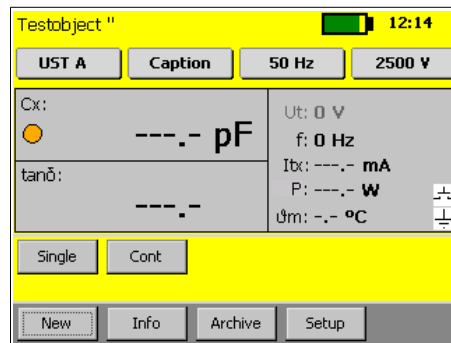

8.2.1.4 Test object

At the top of the screen the name of the actual profile is visible. Change it by pressing “Info” and select the tab “Name Plate”.

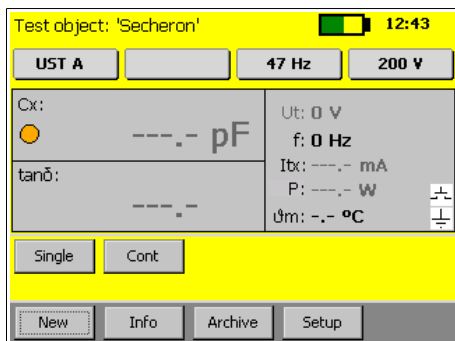



8.2.1.5 Time

The actual Time is visible in the main screen to the right of the battery symbol. The time and the date is adjustable in the Setup under Clock. Have a look on chapter 8.2.7.1.3 Clock on page 42.

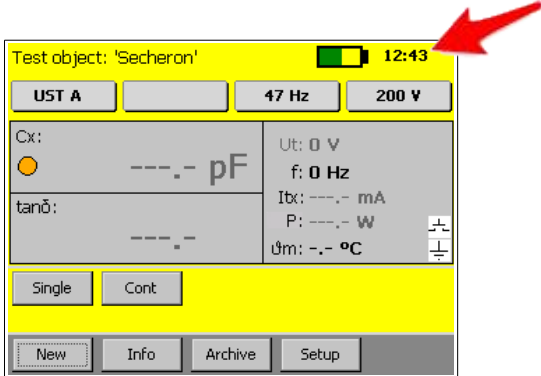

8.2.2 Measurement Mode

The actual measurement Mode is visible on the main screen.

If you need to change it, press on it and a new window will open.

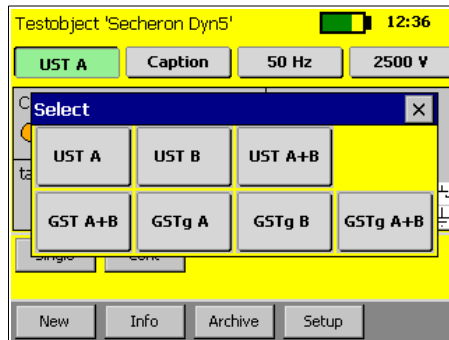
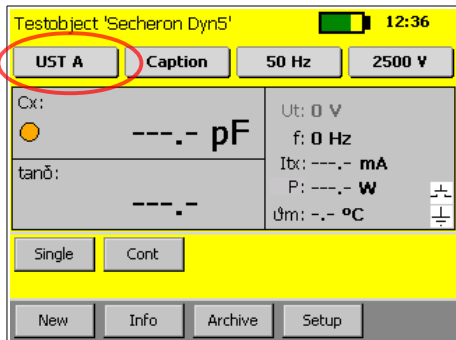

For more information about the measurement modes see chapter 9 Measurement Modes on page 55.



8.2.3 Caption

This is a user defined text that marks the results.

The actual text of the caption is visible on the main screen.

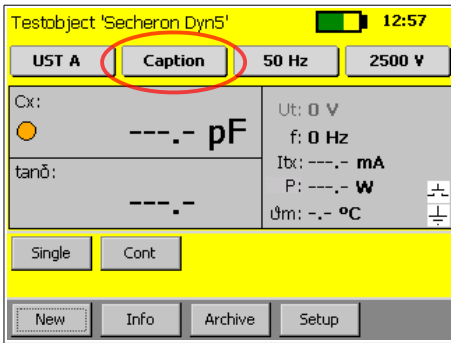

If you need to change it, press on it and a new window will open.

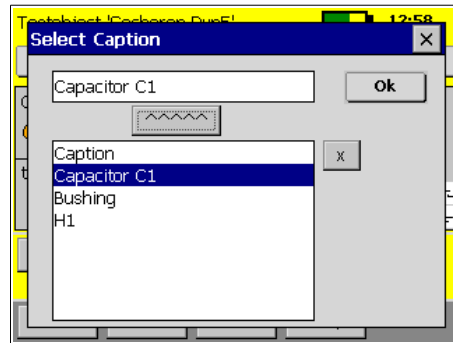

Select a text from the list and press the "^^^^^^"-button.

or click on the text field to change the actual text or enter a new one.

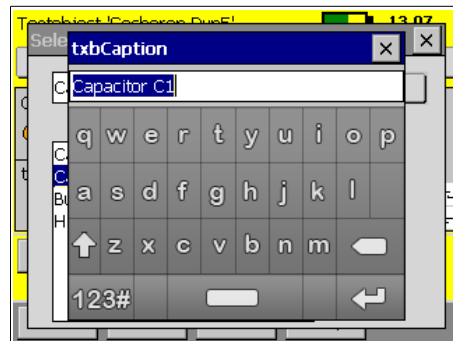
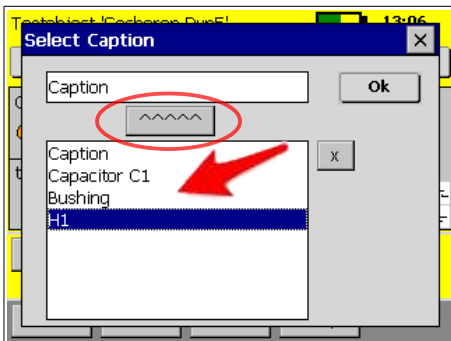



8.2.4 Measurement frequency

The actual measurement frequency is visible on the button.

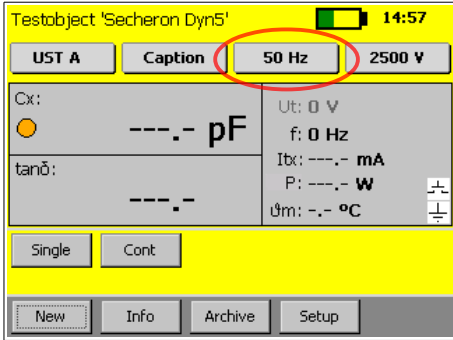

If you would like to change it, press on it and a new window will open. This is also possible during a measurement.

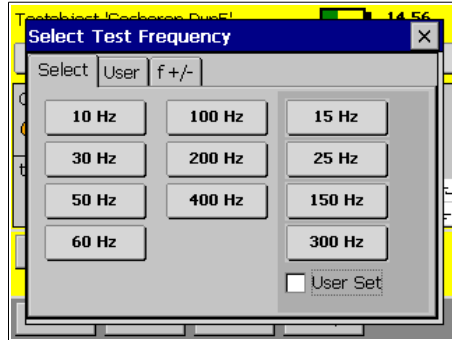

Select the frequency you want. The 4 buttons on the right can be set by the user, just select the checkbox and you can change them.

On the second tab "User" you can increase or decrease the actual frequency.

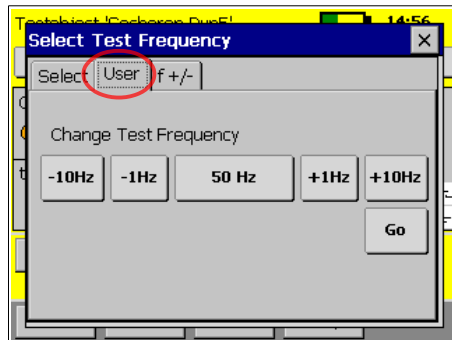
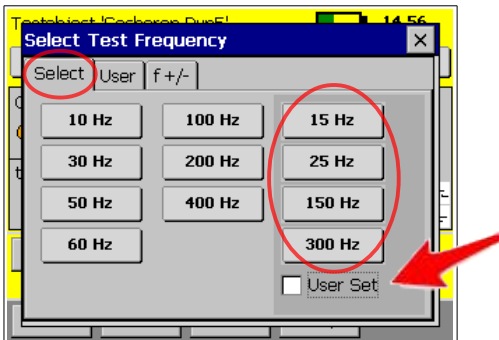



On the third tab "f +/-" you find a solution if you have heavy interference on the line frequency.

The CAPO is performing measurements in addition to the selected frequency but will calculate the result based on the selected frequency.

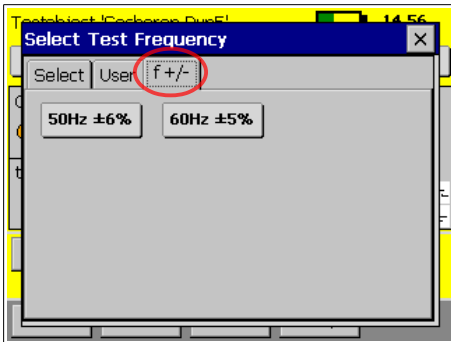

In this mode, the continuous measurement is not possible anymore, because it doesn't make sense.



8.2.5 Measurement voltage

The actual measurement voltage is visible on the button.

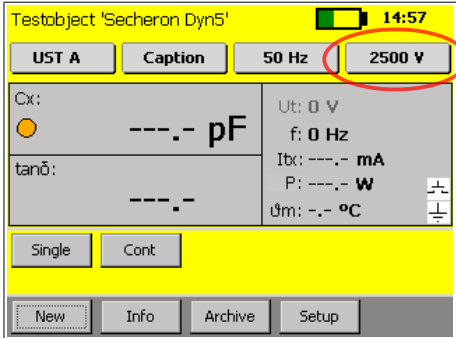

If you would like to change it, press on it and a new window will open. This is also possible during a measurement.

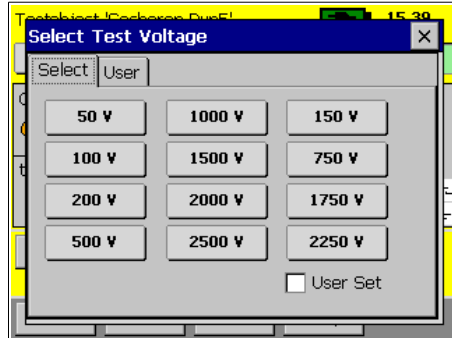

Select the voltage you want. The 4 buttons on the right can be set by the user, just select the check-box and you can change them.

On the second tab "User" you can increase or decrease the actual voltage.

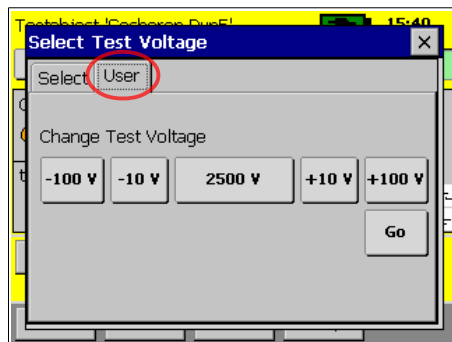
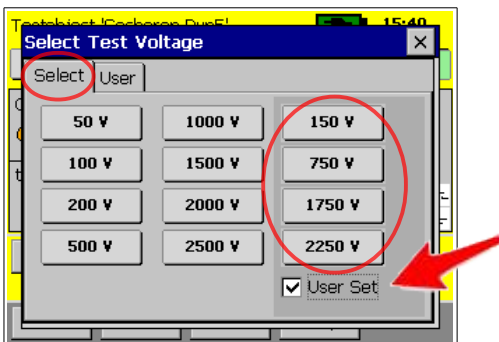



8.2.6 Start a measurement



WARNING!

Hazardous voltage may result in severe injury or death!

Before performing any test with this instrument, read this user manual and observe all safety precautions indicated. Especially read the chapter Safety on page 6.

The FIRST cable you have to connect and lead to earth ground is always the Safety GND!

There are two possibilities to start a measurement, single and continuous.

8.2.6.1 Single measurement

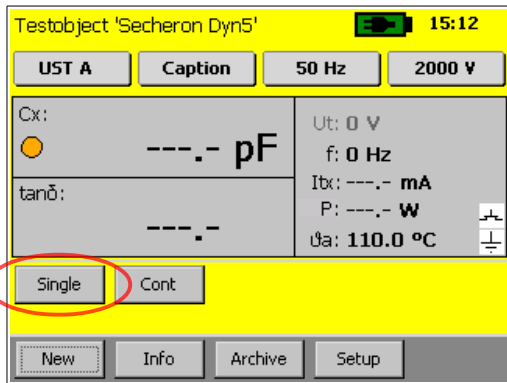

To start a single measurement press and hold the safety-switch and afterward press the button "Single".

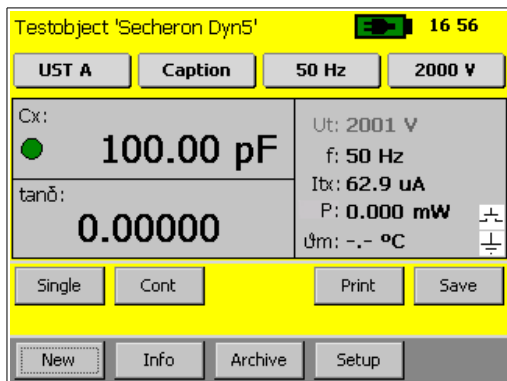

The CAPO will do the measurement and after you get a stable result, it will automatically stop the measurement.

You can store the result or directly print it out.



8.2.6.2 Continuous measurement

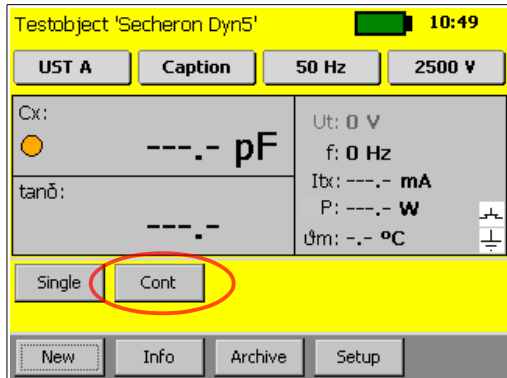

To start a continuous measurement press and hold the safety-switch and afterwards press the button "Cont".

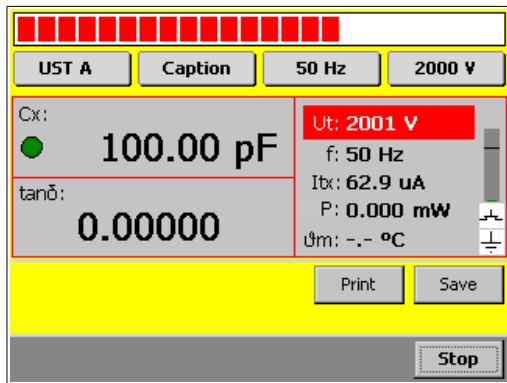

During the measurement you can change the measurement mode e.g. from UST A to GSTg B... You also don't have to stop the measurement if you want to change the frequency or the voltage.

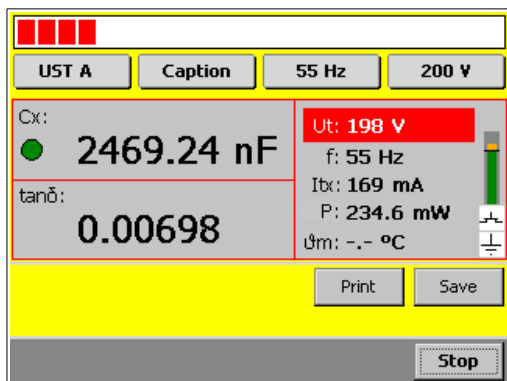

During the measurement there is a bar on the right side of the display. It indicates the current which is actual flowing. The black line means 150mA.



During or after the measurement you can touch the dissipation factor measurement to switch between tangens delta ($\tan \delta$) and the Power Factor (PF).

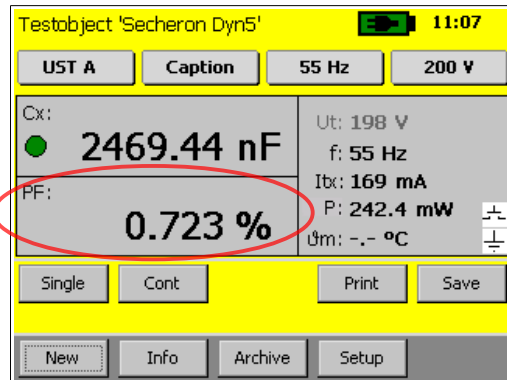
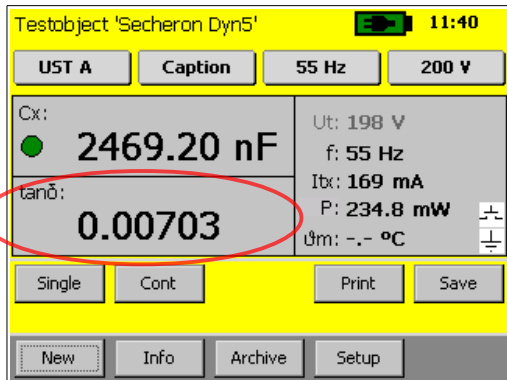

Small values of $\tan \delta$ or PF) will have the same numbers.

If you touch the Cx value, the display will change to Lx. This is useful if your test object is inductive. If your test object is capacitive and you change to Lx, the value will be negative.

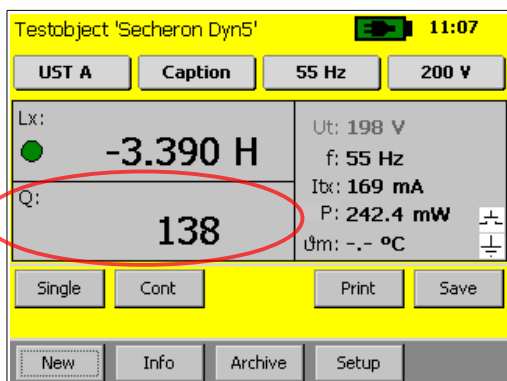
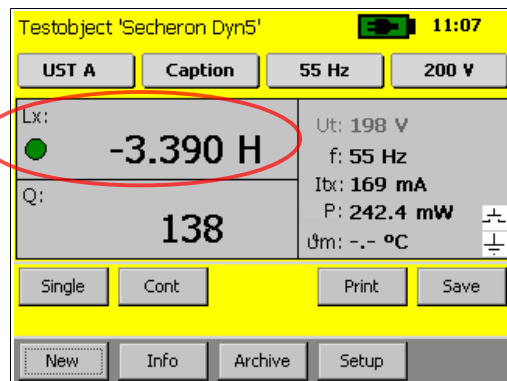
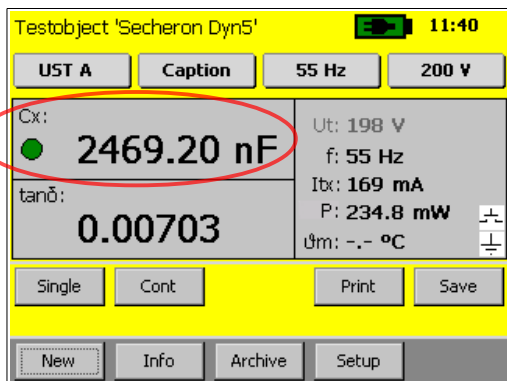

Instead of the $\tan \delta$ / PF you will see the Quality Q: on the display if you changed to Lx.



8.2.7 Setup

By pressing the Setup button, the Setup screen will appear.

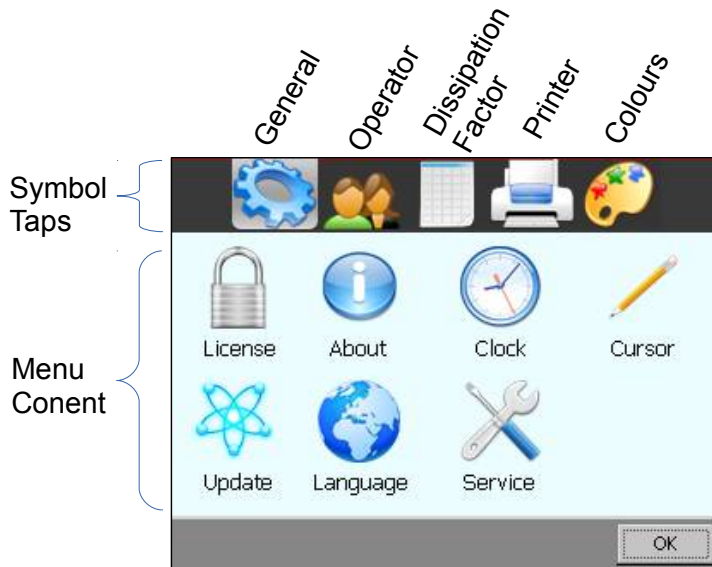

The setup menu contains the following five parts:

- General
- Operators
- Dissipation Factor
- Printer
- Color

They can easily be switched with the symbol taps on top of the screen.

The content of this five parts is described in the following chapters.



8.2.7.1 General

The General tap contains the 7 following parts:



8.2.7.1.1 License

License Manger is used to enter a Raytech license number. If your license state changes, you may be asked to enter a new license.

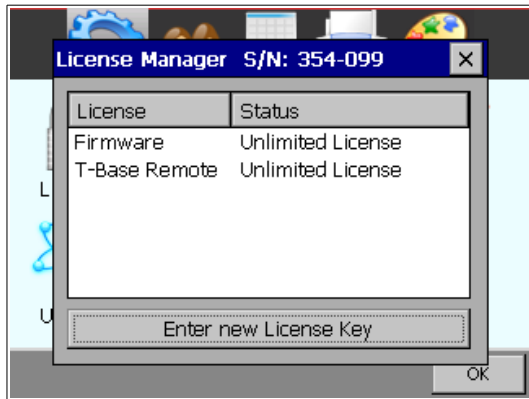

License Manager

This menu displays the actual license state. By touching the 'Enter New License Key' button, you can do so.



Extend the license

To modify or extend the license, enter a new license code.

The license code is generated by Raytech GmbH.



8.2.7.1.2 About



Choose this menu to get information about the instrument like firmware version and serial number.

8.2.7.1.3 Clock

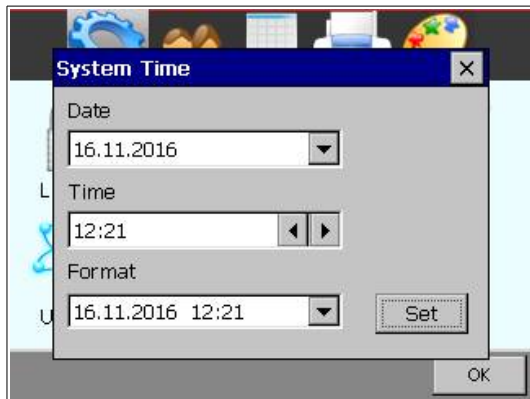

Use this menu, to set date and time. This is important for your data sets, because your measurement will contain a time stamp.

8.2.7.1.4 Cursor

This option is important when using a USB mouse. Use it to switch cursor on and off. But normally you don't have to switch to USB mouse, it will automatically recognize it if you connect a USB-Mouse or a Track ball. The instrument can then be fully controlled by the mouse.



8.2.7.1.5 Update



New Firmware versions are available free of charge at www.raytech.ch.

Download the new Firmware (.zip file) onto your USB key on the root directory (Not in a sub-directory and do not Unzip it).

Connect the USB key to the instrument and press install. The system will detect and automatically install the new firmware and restart the system.

8.2.7.1.6 Language



The CAPO firmware supports several languages. Use this menu, to choose your favorite language from a list of all available languages.

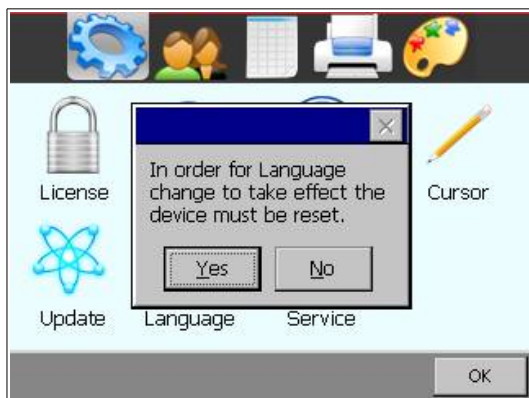

Restart the instrument to activate the desired language selected.



8.2.7.1.7 Service

There are several embedded codes to allow different settings, e.g. calibrate the touchscreen, activate USB-driver and so on. For more information see chapter C Service Mode on page 74.

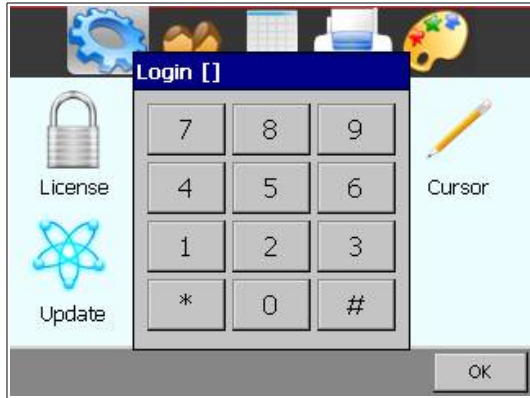

The Service Mode has a limited access.

Enter the corresponding code or exit directly by pressing '#'.

8.2.7.2 Operator

Every measurement can be stored with the name of the actual operator. In this menu, new operators can enter their first name and last name. Existing entries can be changed.

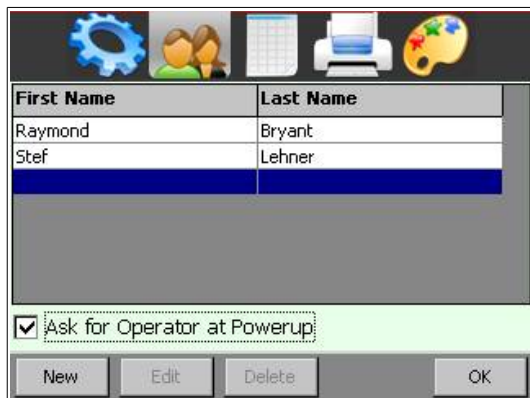
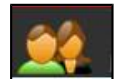

Touch an operators name and then touch 'ok' to make your choice.

Note the 'Ask for Operator at Powerup' check box. When checked, you will be asked if the chosen operators name is yours during the start up of the instrument. This may be helpful, when several operators are using the same CAPO 2.5.



8.2.7.3 Oil Correction Table⁴



It is possible to make a measurement correction of the PF or $\tan \delta$ on the basis of the temperature. To have access to this feature, you must first enter the service code "1200#." To find out how to do this, check chapter C in the appendix "Service Mode" on page 74.

Normally this feature is disabled. But if you need it, read chapter C.5 "Oil Correction Table" in the appendix on page 77.

8.2.7.4 Dissipation factor

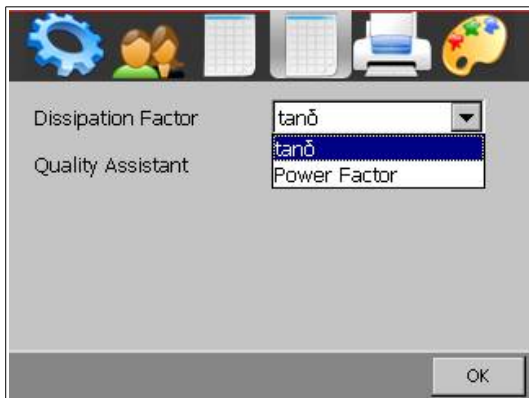

Here you can choose between the dissipation factor $\tan \delta$ or the power factor $\cos \varphi$. The one you selected will be on the print out and standard on the measurement display. You can still change the standard on the measurement display by touching directly on the value of the dissipation factor.⁵

⁴ This is only available if you entered the Service Code "1200#"

⁵ This will only change the factor on the display, the print out is the one you select in this Setup.



8.2.7.5 Quality Assistant

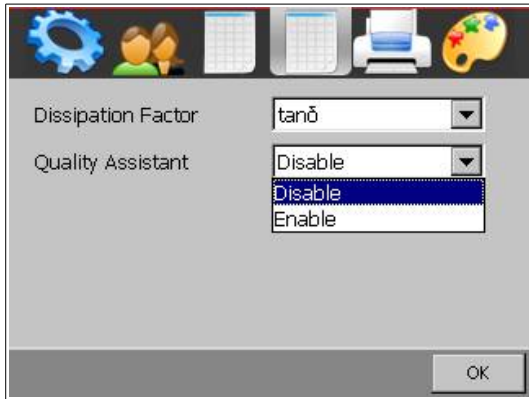

If the Quality Assistant is enabled, a light in the main screen indicates the quality of the test result.

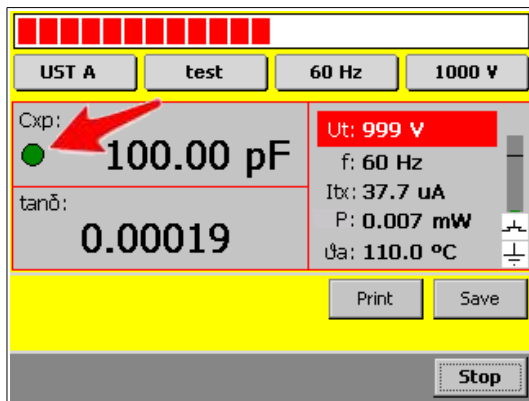

If the light is green, the measured result is stable.



8.2.7.6 Printer

If you are able to use an external USB Printer, you should choose the correct emulation.

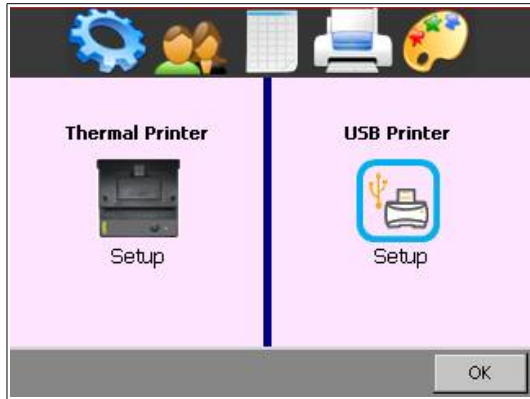

Connect your USB Printer to the CAPO's USB host connector.

Touch the USB Printer symbol and select the emulation of your USB Printer.



Maybe you would like to print a test page, to make sure everything works properly.

For more Information see Appendix D USB Printer Info on page 79.



8.2.7.7 Color

Two recommended color schemes are available.



Indoor and in moderate sunlight you may prefer the colored scheme.

In bright sunlight black and white provides maximal contrast to make sure everything remains readable.



8.3 Results and data structure

The measurement results can be stored on the internal memory or on an external USB-key. It's possible to exchange the results from the internal memory to external USB-keys or direct to a computer.

For easy organization of all measurement results, we created "test objects". Under a test object it is possible to store multiple measurements.

To work with the test objects and organize the results there are three buttons on the main screen:

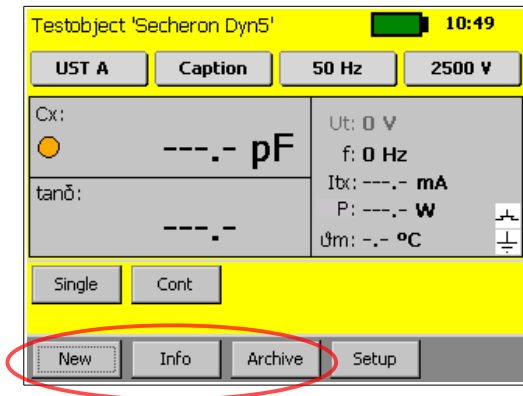

8.3.1 New

A new window will open after pressing the button New:

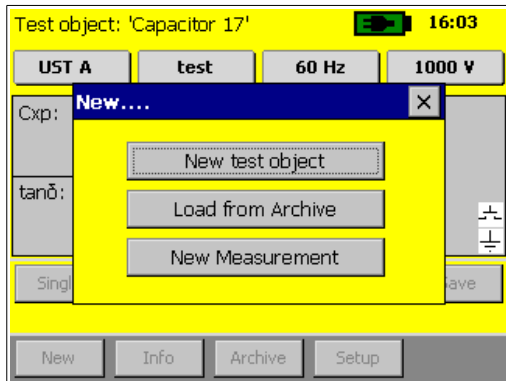



8.3.1.1 New test object

To create a new test object, select “New test object”.

Test object Info	
Name	<input type="text"/>
Plate	<input type="text"/>
Actual Result	<input type="text"/>
Type	<input type="text"/>
Manufacturer	<input type="text"/>
Location	<input type="text"/>
Remarks	<input type="text"/>

Buttons: Result, Print, OK

Just tap on the input window you would like to change and a new window will open with a keyboard⁶:

Test object Info	
Name	<input type="text"/>
Plate	<input type="text"/>
Actual Result	<input type="text"/>
Type	<input type="text"/>
Manufacturer	<input type="text"/>
Location	<input type="text"/>
Remarks	<input type="text"/>

Buttons: Result, Print, OK

⁶ It's also possible to connect an external USB-Keyboard or Mouse to control the CAPO.



8.3.1.2 Load from Archive

If the test object is already in the memory from e.g. an earlier measurement, select “Load from Archive”:

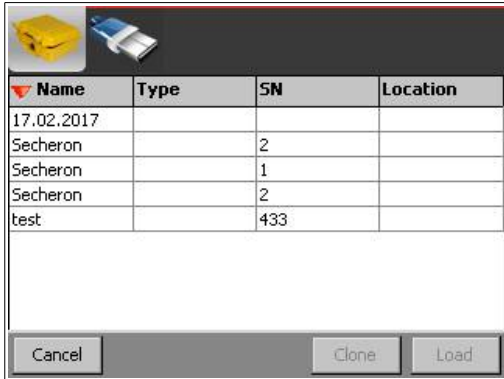

Now you can load an existing test object from the memory on the instrument or from a USB-key, if a USB-key is connected.

8.3.1.3 New Measurement

This creates a new measurement under the actual test object.



8.3.2 Info

Under Info “Name Plate” get the information about the test object:

Test object Info 'Capacitor'		
Name Plate	Name	Capacitor
Actual Result	S/N	1973-b
	Type	MCP
	Manufacturer	Raytech
	Location	Bremgarten
	Remarks	top
Result		
		Print
		OK

Select “Actual Result” and you see an overview about the measurements in this test object:

Test object Info 'Capacitor'		Archive
Name Plate	<input checked="" type="radio"/>	17.02.2017 16:45 (CAPO25 363-189)
Results		
Result		
		Delete
		Print
		OK



8.3.3 Archive

Here you see all the test objects in the internal memory and on the USB-key:

Name	Type	SN	Location
17.02.2017			
17.02.2017			
Capacitor	MCP	1973-b	Bremgarten
Secheron		1	
Secheron		2	
Secheron		2	
test		433	

Select All OK

The actual test object is blue.

If you select one, it gets highlighted in black:

Name	Type	SN	Location
17.02.2017			
17.02.2017			
Capacitor	MCP	1973-b	Bremgarten
Secheron		1	
Secheron		2	
Secheron		2	
test		433	

Info Load Delete Export OK

8.3.3.1 Info

If you now select "Info", you get the information about the test object and its measurements:

Test object Info 'Capacitor'		Archive
Name Plate	Name	Capacitor
	S/N	1973-b
Results	Type	MCP
	Manufacturer	Raytech
	Location	Bremgarten
	Remarks	top

Result Print OK

Test object Info 'Capacitor'		Archive
Name Plate	<input type="radio"/>	17.02.2017 16:45 (CAPO25 363-189)
Results	<input checked="" type="radio"/>	17.02.2017 16:38 (CAPO25 363-189)

Result Delete Print OK



Here it's possible to delete or print (on the internal or an external printer) the measurements.
If you would like to see the measurement results, select Result:

Time	Mode	Range	Remark
17.02.2017 16:45	Cont		

Details Delete Export.. Esc

Config	Caption	Cxp	Tand	Freq	Utest	Tem
UST A	test	99.98 pF	0.00019	60 Hz	1000 V	25.0

Header Delete Print Esc

Under "Export" all the measurements can be exported onto a USB-key in a csv-file. If no measurements are selected, the entire memory will be printed or exported.

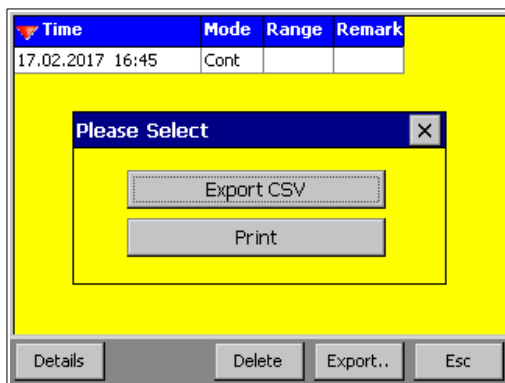

Press "Print" to print the results.

Press "Export CSV" to export the data in a csv file.

This csv-file can be opened e.g. with Microsoft Excel or Libre Office Calc.

The csv-file is named with CAPO, the serial number of the instrument, the test object and the date and time. You can locate the file in the directory: Raytech\EXPORT on the USB Key.

To select the CSV Separator, see chapter C.3 CSV Separator in the attachment on page 76.



9 Measurement Modes⁷

9.1 Overview

The CAPO has three measurement inputs: A, B and HV-GND.

Over an internal relays-matrix they are automatically combined for the different measurement modes as followed:

Mode	Measurement Inputs		
	A	B	HVGND
UST A	measured	guarded	guarded
UST B	guarded	measured	guarded
UST A+B	measured	measured	guarded
GST A+B	measured	measured	measured
GSTg A	guarded	measured	measured
GSTg B	measured	guarded	measured
GSTg A+B	guarded	guarded	measured

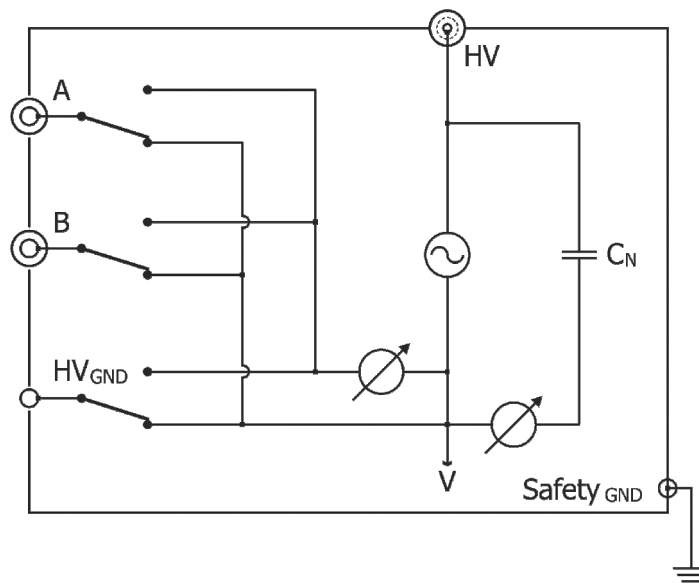

If the measured Input is guarded, it means that the input is internally connected to the so called "V"-potential which is the low voltage point (reference) of the high voltage supply. All current that flows directly to this point will not be measured.

⁷ According to ANSI/IEEE Standard 62, IEEE Std C57.152-2013



To eliminate the stray capacitance, you have to connect the unwanted capacitance to this point. The shield of our measurement cables is also connected to this V-potential. Do not use unshielded measurement cables!

By selecting the different test modes, all combinations of measurements according the ANSI/IEEE Standard 62 can be measured without any rewiring.

9.2 UST Ungrounded Specimen Test

The UST configuration is used for measurements between two terminals of a test specimen that are not grounded or that can be removed from ground. In the UST configuration, current flowing in the insulation between the voltage lead and the measuring lead of the instrument is measured and current flowing to ground is not measured.

The below statements are to be taken as an example for transformers, a lot of different objects, such as CTs, PTs, switch gear, insulators, capacitors, bushings, motors or generators can be measured.

In the example below you measure the capacitance and dissipation factor between high-voltage winding (HV) and low-voltage winding (LV), $C = C_{HL}$.

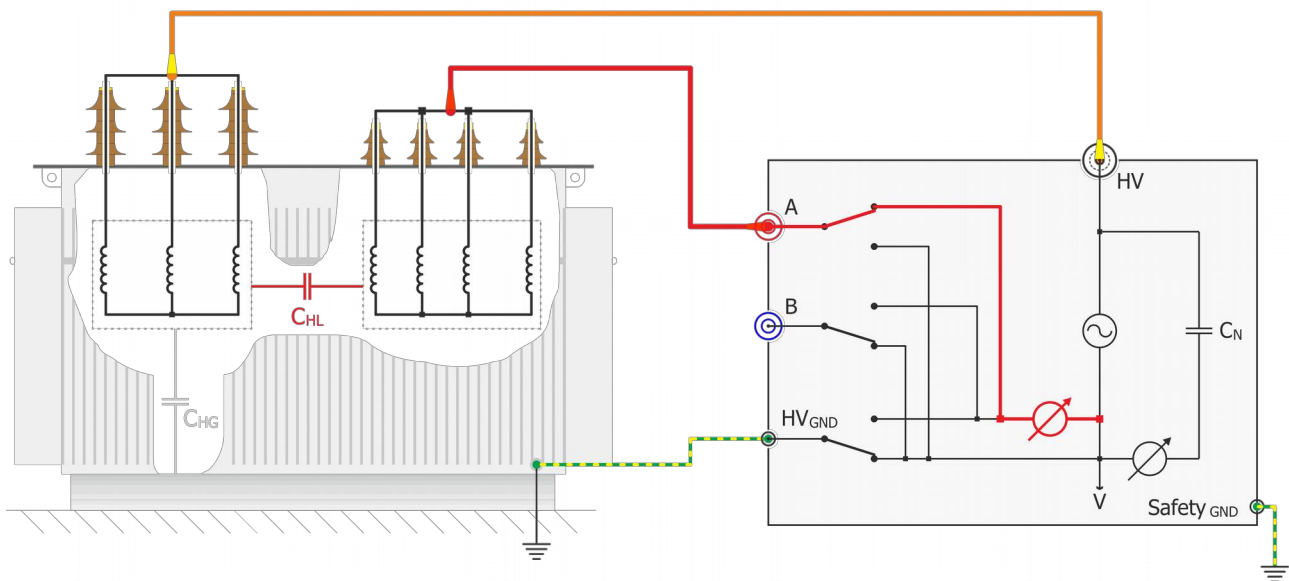

iii. 1: USTA

Measurement of capacitance between high-voltage winding (HV) and low-voltage winding (LV) insulated from ground (casing and supply low HV GND to Safety GND). In the case of two low-voltage windings, either the individual capacitances or their sum can be measured via inputs A and B by setting the selector switch accordingly.



9.2.1 UST A

Ungrounded specimen test channel A, capacitance measured = C_A , (C_B and C_G guarded)

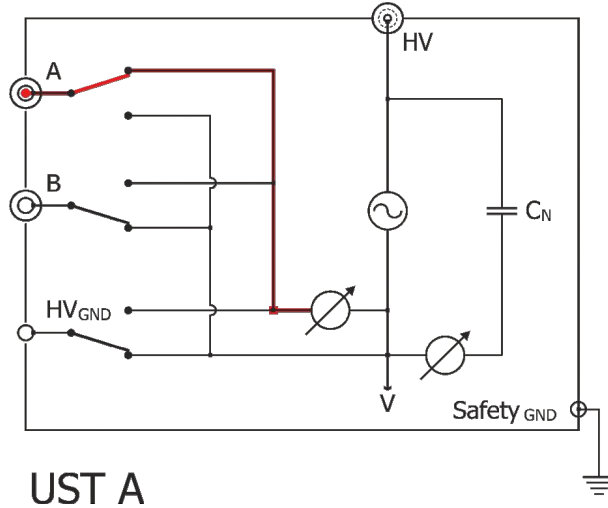

9.2.2 UST B

Ungrounded specimen test channel B, capacitance measured = C_B , (C_A and C_G guarded)

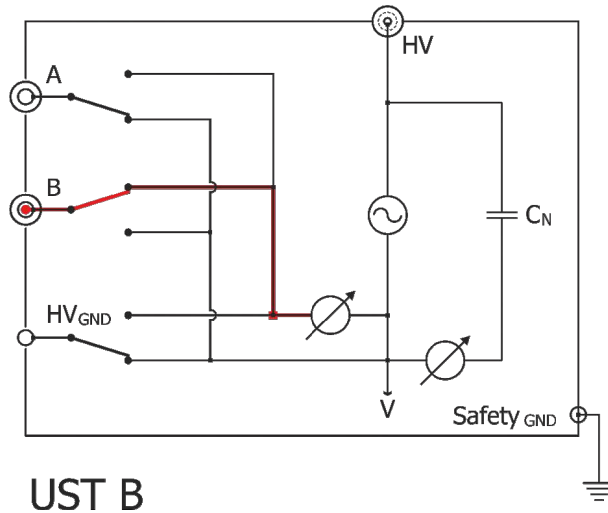



9.2.3 UST A + B

Ungrounded specimen test channel A + B, capacitance measured = $C_A + C_B$, (C_G guarded)

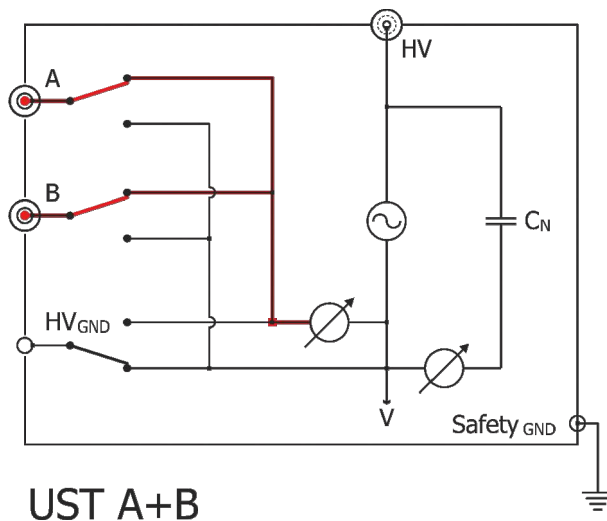



9.3 GST

The GST configuration permits testing of a grounded insulation specimen through the specimen's ground. All current flowing to ground is measured. The configuration is illustrated below:

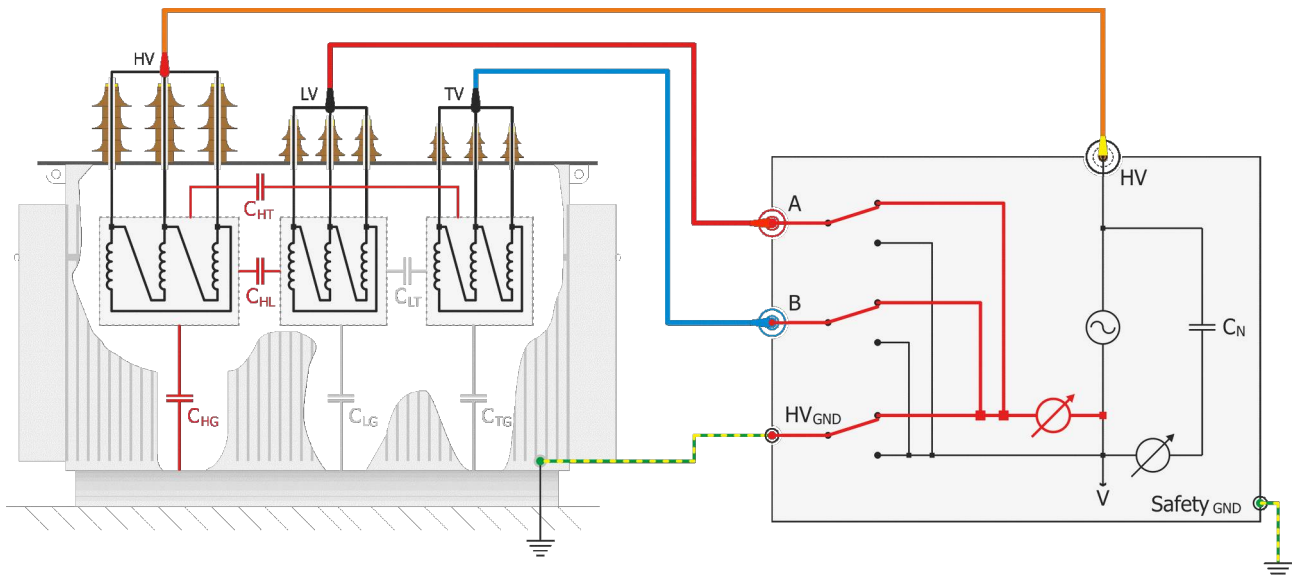

ill. 2: GST A + B

In the example above you measure the Capacitance and dissipation factor between HV and LV (C_{HL}), HV and tertiary TV (C_{HT}) and HV and tank (C_{HG}). The total measured capacitance represents the sum of the three capacitances.

9.3.1 GST A + B

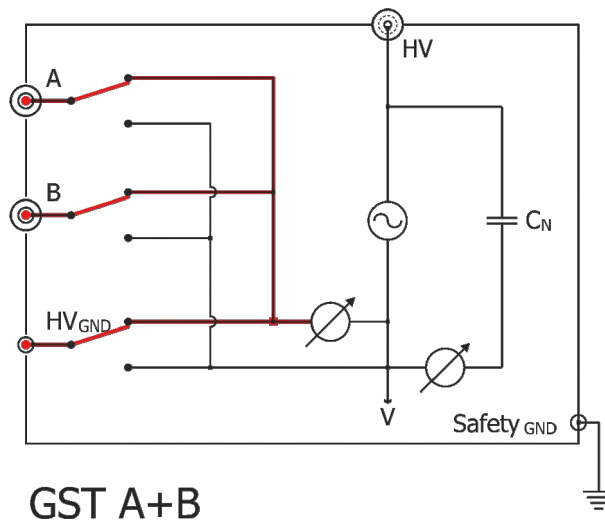



9.4 GSTg

The GSTg configuration allows unwanted currents to bypass the measuring circuit and enables smaller sections of insulation to be tested individually. Only the ground currents are measured using a GST-Guard configuration. Current flowing to terminals with the guard connection is not measured. This configuration is illustrated below:



Abbildung 1: GSTg A+B



9.4.1 GSTg A

Grounded specimen test with guarded A (connected to V), capacitance measured = $C_B + C_G$

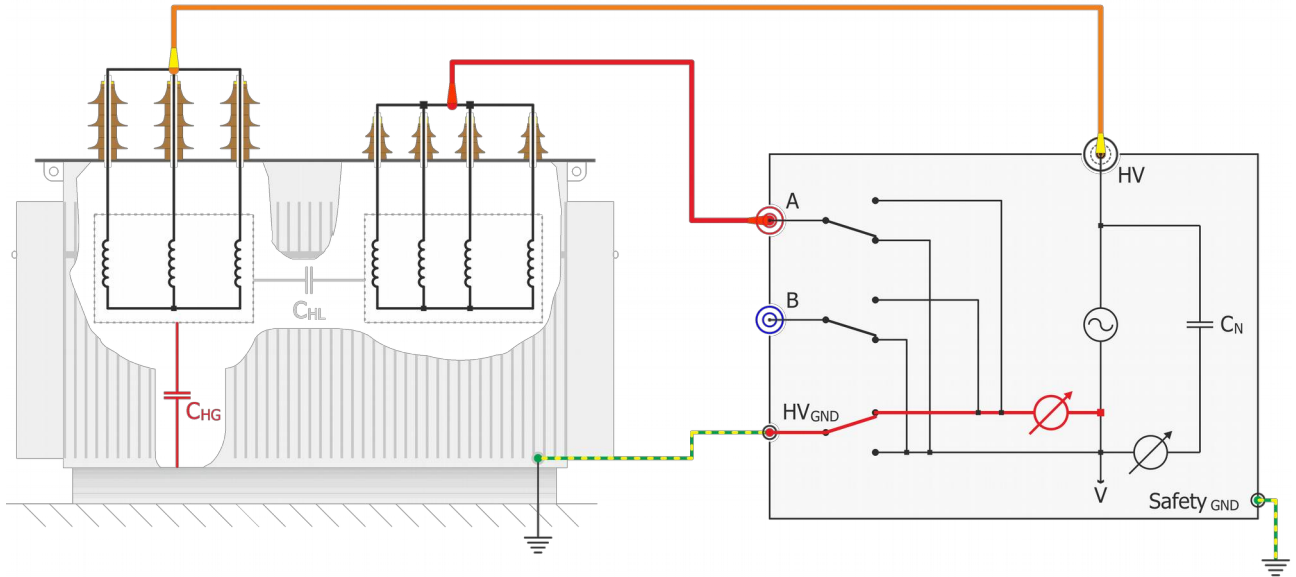
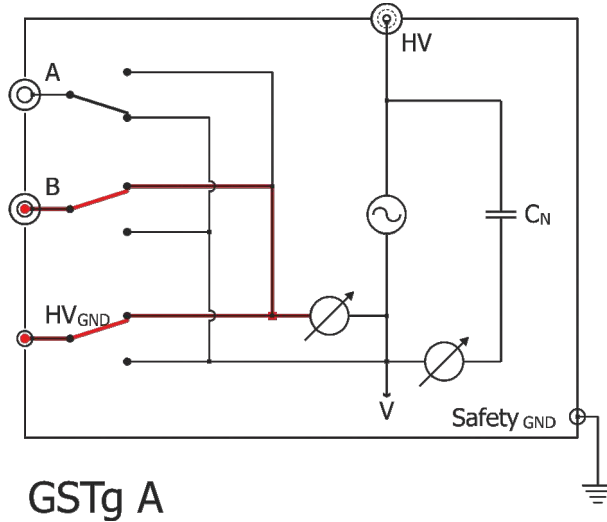

GSTg A

9.4.2 GSTg B

Grounded specimen test with guarded B (connected to V), capacitance measured = $C_A + C_G$

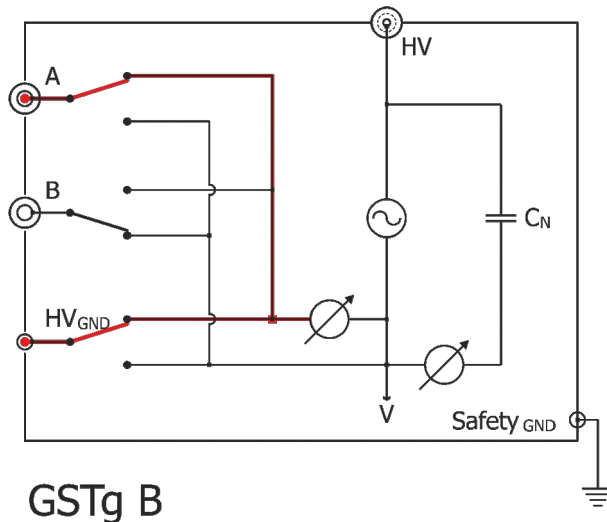

GSTg B



9.4.3 GSTg A + B

Grounded specimen test with guarded A and B (connected to V), capacitance measured = C_G

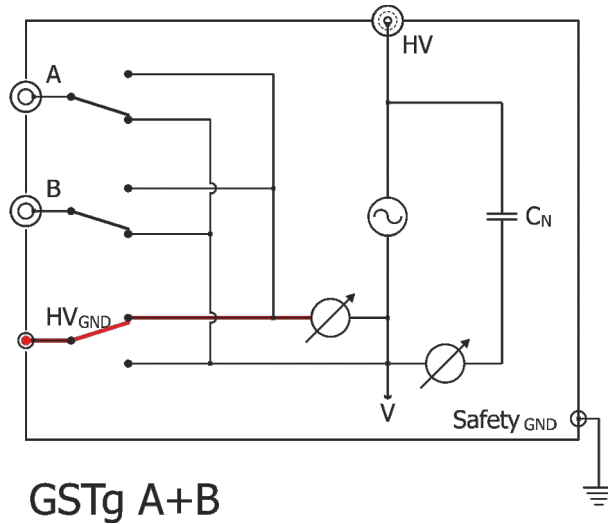



10 Technical Specifications⁸

The CAPO 2.5 is specially designed for fast and easy field measurement and the well known high precision and quality of Raytech.

Type	CAPO 2.5
Size	L: 521 mm (20.5") W: 432 mm (17") H: 216 mm (8.5")
Weight	22.2 kg (48.9 lbs.)
Input Power	85-264 VAC (250 W max.) 47-63 Hz, automatic ranging
Battery	Li-Ion battery pack
Output Voltage	up to 2500V AC
Output Frequency	10Hz - 400Hz
Test Current	up to 200mA
Panel Display	Color LCD with back lighting and touch screen.
Front Panel	Sealed anodized.
Interface	2 x USB 2.0 (1 host / 1 device) and 9 Pin RS232 serial
Memory Storage	Stores up to 10000 complete test results.

Operating Temperature	-10°C to 60°C
Storage Temperature	-20°C to 70°C

⁸ Specifications are subject to change without notice



10.1 Measurement Parameters

Measured values: Dissipation Factor $\tan \delta$, Power Factor $\cos \varphi$, Capacitance, Inductance, Quality Factor, Power (Watts), Power_{@10kV}

	Range	Resolution	Accuracy
Dissipation Factor $\tan \delta$	0 ... 0.1 0.1 ... 1 > 1	1×10^{-5} 1×10^{-4} 3 Digits	$\pm 0.5\% \text{ Rdg} \pm 1 \times 10^{-4}$ $\pm 0.5\% \text{ Rdg} \pm 1 \times 10^{-4}$ $\pm 0.5\% \text{ Rdg}$
Power Factor $\cos \varphi$	0 ... 0.1 0.1 ... 1	1×10^{-5} 1×10^{-4}	$\pm 0.5\% \text{ Rdg} \pm 1 \times 10^{-4}$ $\pm 0.5\% \text{ Rdg} \pm 1 \times 10^{-4}$
Capacitance $C_{max} = \frac{I_{max}}{U \cdot 2 \cdot \pi \cdot f}$	50Hz 0.00pF ... 254nF @ 2.5kV ... 1.3μF @ 500V 60Hz 0.00pF ... 212nF @ 2.5kV ... 1.1μF @ 500V	0.01pF or 5 Digits	$\pm 0.3\% \text{ Rdg} \pm 0.3\text{pF}^9$
Test Voltage	up to 2'500V _{rms} (45 ... 400Hz) f < 45Hz: $U_{outmax} = \frac{2500V}{45 \text{ Hz}} \cdot f$	1V (<1000V) 10V (>1000V)	$\pm 0.5\% \text{ Rdg} \pm 1V$
Test Current	up to 200mA _{rms}	0.1μA or 4 Digits	$\pm 0.3\% \text{ Rdg} \pm 1\mu A$
Output Power	0 ... 500VA ¹⁰		
Output Frequency	10Hz - 400Hz (Step 0.5Hz)	0.1Hz	$\pm 0.01\%$

9 >500V

10 Max 100W



10.2 Features

- Battery operated, world unique
- Built-in Standard Capacitor
- Power Factor $\cos \varphi$ / $\tan \delta$ readings
- Test Frequency 10 Hz to 400 Hz
- Internal thermal printer
- Data transfer to external printer
- Microprocessor based system with internal storage for over 10'000 test results
- Data exchange via USB-Key or USB / RS232 Connection
- Storage and Printing of test results
- Complete automatic calibration system and system diagnostics
- Temperature channel
- Standard USB 2.0 & RS232 (serial) Interfaces
- Color LCD with backlighting and touch screen
- Panel mounted Emergency Stop Switch
- Mounted in rugged case for field testing
- 2 Year standard warranty



11 Interfaces

11.1 Hardware

11.1.1 RS 323

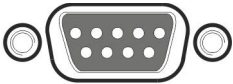

RS 232

1 x RS 232, 9 Pin

Pin 2 TxD (WR-> Host)
Pin 3 RxD (Host-> WR)
Pin 5 GND

Interface Parameters:
(fixed, unchangeable)

Port	RS232
Baudrate	38400Baud
Databit	8 Bit
Stopbits	1 Bit
Parity	No

11.1.2 USB



USB-Master

Standard 2.0

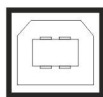

USB-Slave

Standard 2.0



11.1.3 Safety

This is the plug for the Safety-Switch.

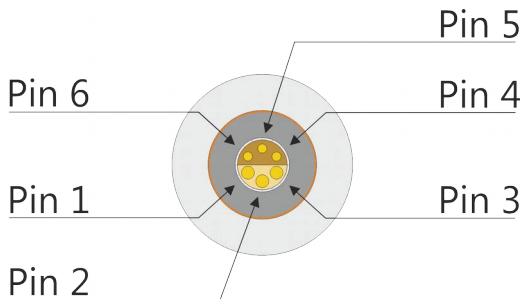

Safety

Front View

Pin 5 and pin 6 are part of the extended safety circuit. When these contacts are open the instrument acts as if the emergency stop has been pressed.

If you press the Safety-Switch, pin 5 and 6 will be closed.

You can use **pin 3 and pin 4** to connect an external Warning Light or Beeper to indicate a dangerous condition.

There is an internal Relay whose contact is connected to the plug “Extern”.

An external power source and a Warning Light or Beeper may be connected to pins 3 and 4 to indicate a dangerous condition. See: Example for connecting an external warning device below.

Use the working contact between Pin 3 and Pin 4, maximum Load 240VAC 2A.



The contact is open when the system is Safe.

The contact is closed when the system is Unsafe.

Pin 1 and pin 2 on the Safety connector: These pins are for Raytech Service use. Do not connect anything to these pins!



11.1.4 Temp

This is the plug for an external temperature probe. Connect the TP 01 from Raytech and the CAPO will display the actual temperature and store it together with the test results.

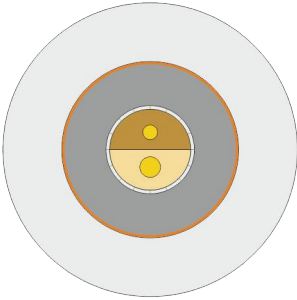

Temp

Front View



Appendix



CAPO 2.5

Capacitance and Power Factor Meter



Appendix

A Software Development Kit (SDK).....	71
B Command Syntax.....	72
B.1 Raytech USB/Serial Port Driver.....	72
B.2 Command Syntax.....	72
B.3 Answercodes.....	72
B.3.1 Synchronus Answers.....	72
B.3.2 Asynchronuous Answer.....	73
B.4 Serial Interface.....	73
B.5 USB Interface.....	73
C Service Mode.....	74
C.1 Calibrate Touchscreen.....	74
C.2 Show Ground Warning.....	75
C.3 CSV Separator.....	76
C.4 Raytech USB Driver.....	76
C.5 Oil Correction Table.....	77
D USB Printer Info.....	79
E Error Messages.....	80
F Trouble Shooting.....	81
F.1 Test Voltage cannot be turned on.....	81
F.2 Touch Panel does not work.....	82
F.3 USB Memory Stick does not work.....	82
F.4 Cannot switch off the CAPO.....	82
G Warranty Conditions.....	83
H Contacts.....	85



A Software Development Kit (SDK)

The SDK is a device management software with various possible applications. It is essentially a software layer (or driver) that resides between the Operating System (OS) IO system, custom Windows Application and Raytech instruments. The SDK with native Raytech USB Driver for Windows provides the OS with full device functionality, appearing to OS as a Raytech USB device. This software can also be used without native Raytech USB drivers to control the device over the standard RS 232 Serial port.

It is a powerful tool to write easily customized Software to control the Raytech Instruments.

For more information download the SDK Quick Start Guide at www.raytech.ch.



B Command Syntax

It is possible to control the instrument over the RS 232 or the USB port with an external computer. It is also possible to write your own test program for a fully customized test procedure.

A description of all commands (90235 Command Set CAPO) and more details is stored on the delivered USB-Key. The newest version can always be downloaded from the internet at www.raytech.ch.

B.1 Raytech USB/Serial Port Driver

Raytech is providing a SDK for Software integrations in .NET Projects. For more information have a look at chapter A Software Development Kit (SDK) on page 71.

B.2 Command Syntax

Cmd [Para[,Para2..]] LF"

Separator for Cmd and Parameters ' ' (space 0x20)

Separator for Parameters: ','

Numeric Format of Numbers: float (C - Language), "." as decimal point

Format of Strings: all ASCII Characters from 0x20 to 0x7f]

B.3 Answercodes

B.3.1 Synchronus Answers

Answer to a command:

Response Code	Remarks
"*0 ok"	Ok
"*1 unkn"	Unknown Command
"*2 Error"	Syntax Error
"*3 Emerg"	Emergency is pressed
"*4 Range"	Parameter is out of range
"*5 Missing Parameter"	Missing Parameter
"*7 Internal"	Internal Error
"*99 No Authorization"	Invalid License



B.3.2 Asynchronous Answer

Events/Redirected Messages:

Response Code	Remarks
"@*10 Exc, "	Redirected Exception, e.g Overcurrent
"@*11 Err, "	Redirected Error
"@*12 Wrn, "	Redirected Warning
"@*13 Msg"	Redirected Message, Status
"@*15 Settings, "	Redirected Settings Message
"@*19 Set to Local"	"Local" Button pressed on the CAPO
"@*20 Start"	Measurement started
"@*21 End"	Measurement stopped
"@*R0, "	Results formatted value with unit
"@*R1, "	Results formatted as float

B.4 Serial Interface

Interface Parameters

Parameter	Value
Port	RS232
Baudrate	38400Baud
Databit	8 Bit
Stopbits	1 Bit
Parity	No
TxD (CAPO-> Host)	Pin 2
RxD (Host-> CAPO)	Pin 3
Gnd	Pin 7
Signal	+/- 12V

B.5 USB Interface

To communicate with the CAPO over USB it is necessary to switch to Raytech Driver Mode.

Enter Service Code "2001" to set USB Driver Mode. This is normally already done. For more information have a look at chapter C.4 Raytech USB Driver on page 76.



C Service Mode

The Service Mode has limited access. There are several codes accessible for setting parameters.

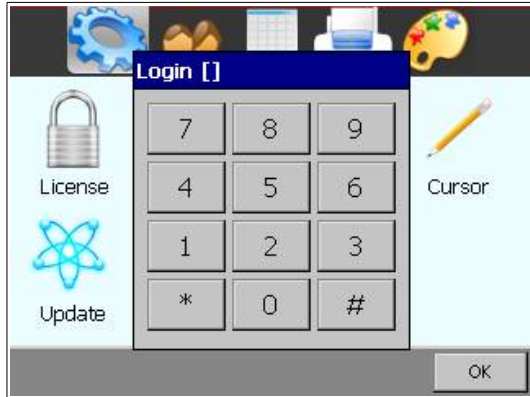

From the main screen press 'Setup'. Then in the General screen press 'Service'. Enter the corresponding code or Exit by pressing '#'.

C.1 Calibrate Touchscreen

The touch screen parameters can be calibrated by the enduser. Enter code **0000#** and follow the on screen instructions as depicted below.

You will see the following screen:

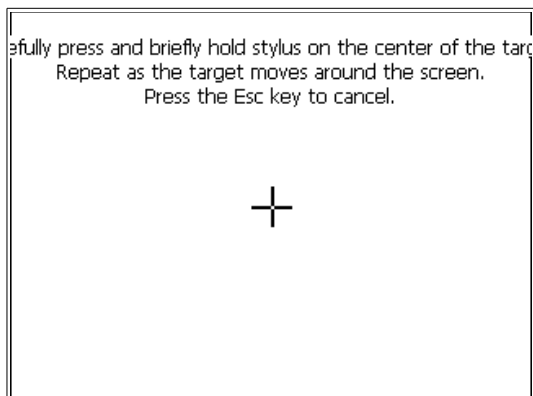

Press and hold stylus on the center of the target until the cross moves.

Repeat as the target moves around the screen.

If a keyboard is connected, press Enter to accept the new parameters or Esc to escape.

If a keyboard is not connected, press anywhere on the screen to accept the new parameters.



C.2 Show Ground Warning

Enable or disable a warning message when the instrument is powered on by entering the Service Code **0200#**



Select Yes to enable the message.
Select No to disable the message.

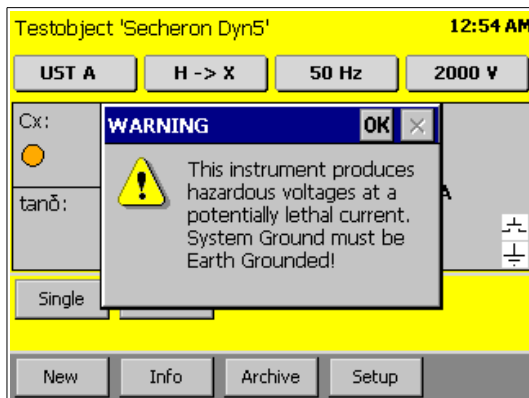

If the warning message is enabled, it will be displayed at every boot-up of the instrument and the message must be acknowledged to continue.



C.3 CSV Separator

For the export of the data in a csv-file¹¹ you are able to change the separator.

You can set the CSV Separator with the following Service Codes:

- CSV Separator ';' Code **2010#**
- CSV Separator ',' Code **2011#**
- CSV Separator '\t' Code **2012#**

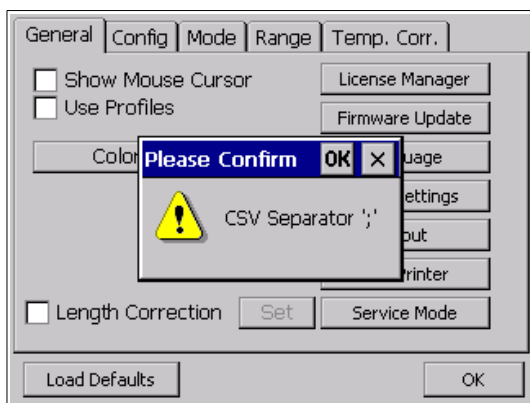

Example:

After entering the Code '2010#' in the Service Mode, the CSV Separator is ';'.

C.4 Raytech USB Driver

If you would like to send commands to the CAPO over the USB-port, you have to activate the Raytech USB driver.



Use the Service Code **'2001#'** to do so, but normally it's already done.

¹¹ Have a look on page 54 how to export the data in a csv-file.



C.5 Oil Correction Table

In the Setup it is possible to make a measurement correction of the PF / $\tan \delta$ on the basis of the temperature.

To have access on this feature you have to first enter the service code "1200#".



In the Setup you have access to this menu. Here you can activate it and choose the correction table.

With **Info**, you see the table on the screen.

Delete will delete the selected table.

Use **Import / Export** to exchange tables with the connected USB-key.

The file looks like IEEE C57.12.90.oct. It is on the root of the USB-key. You can edit the file e.g. with a text editor, Microsoft Excel, Libre Office Calc etc.

	A	B
1	Name:IEEE C57.12.90	
2	Temp	Factor
3	10	0.8
4	15	0.9
5	20	1
6	25	1.12
7	30	1.25
8	35	1.4
9	40	1.55
10	45	1.75
11	50	1.95
12	55	2.18
13	60	2.42
14	65	2.7
15	70	3

This is an Example of an Oil Correction Table.

If the Oil Correction Table is activated, you have to connect our Temperature Probe to measure the oil temperature or enter the oil temperature manually. For that just tick on the main screen on ϑ_m : -.- °C.

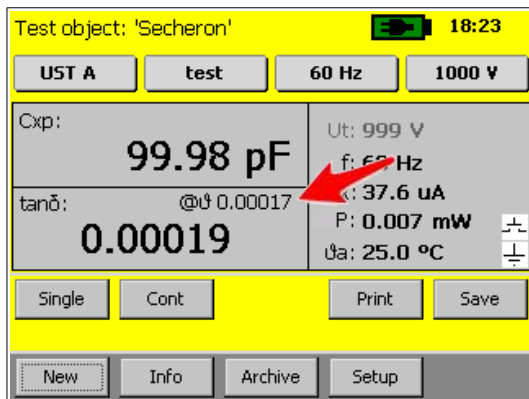

The Oil Correction Table is activated on the left screenshot.

Over the measured $\tan \delta$ the calculated $\tan \delta$ is written in small letters @δ 0.00017.



D USB Printer Info

Printer Requirements

- Languages:
- HP PCL
 - Epson ESC/P 2
 - Epson Stylus COLOR
 - Canon BJ (300 dpi)
 - Canon BJ (360 dpi)
 - Epson LX (9-pin)

Driver

The Printer must conform to Standard USB class 7.1 device. Nearly every Printer conforms as such with the exception of multifunction devices (e.g. All in One Printers).

Interface

USB 2.0

Suggested Printers

- Ink-Jet:
 - Canon iP90
 - Epson Stylus S20
 - HP-Deskjet 6940
 - HP-Deskjet H470B
 - HP-Deskjet H470WBT
 - Epson Stylus Office B40W

- Laser:
 - Brother HL-5240 (Tested)
 - Brother HL-2140
 - Brother HL-5240L
 - HP-Laserjet P1505N
 - HP-Laserjet P2055DN
 - HP Color Laserjet CP2025N
 - PocketJet 200
 - PocketJet II

The information in this document is subject to change without notice.



E Error Messages

Raytech instruments are designed to be precise, rugged and trouble free. In most cases, many operators will never see any error messages.

Below is an example of a message:

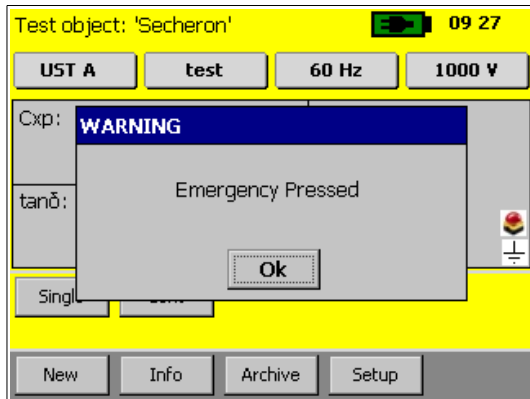

The emergency switch is activated.

In this condition it is not possible to start a measurement.

Exit this message screen by touching "OK" without releasing the emergency switch.

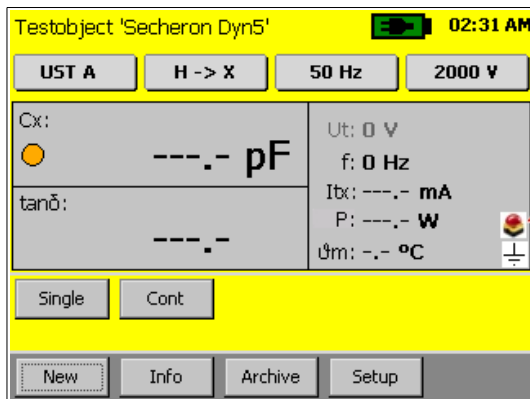

The system will revert to a pretest or main screen similar to the one shown:

Because the emergency switch is still depressed, you are not able to start a new measurement.

All other features of the system such as storing, printing are still active.



Turn the Emergency Stop button clockwise to release.



F Trouble Shooting

When the CAPO is powered on an internal calibration and check sequence is performed. Upon completion of the check sequence the test set will proceed to the “Main Screen”. Should there be any problem detected with the test set an error message will appear.

F.1 Test Voltage cannot be turned on

Press the safety-switch before starting the measurement.

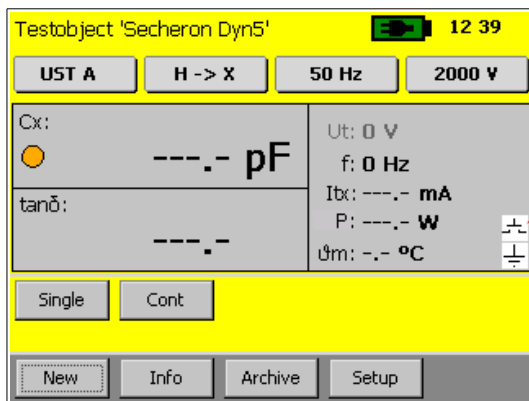

If the contact is open, the safety-switch is not pressed.

The safety GND or the HV GND is not connected

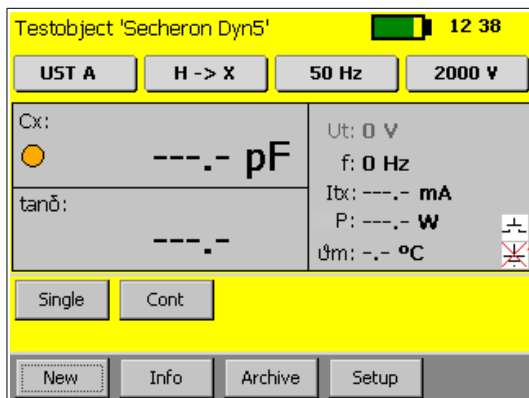

The earth-symbol is crossed if an earth is missing.



Is the Emergency stop switch pushed in? Turn it counter clockwise to release.

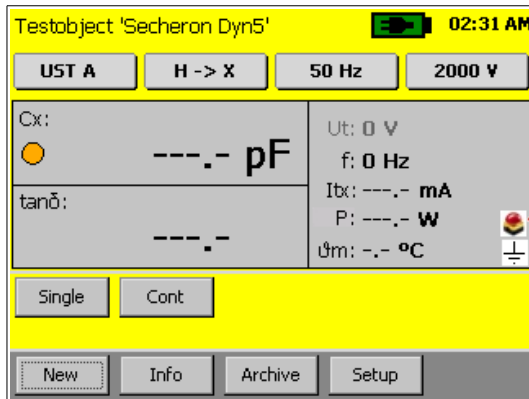

If the emergency button is pressed, there is a mushroom button visible.

F.2 Touch Panel does not work

Connect a USB mouse to the USB port and control the instrument with it. The instrument will automatically display a cursor and everything can be done by mouse. See chapter 8.2.7.1.4 Cursor on page 42.

Try to recalibrate the touch panel: See chapter C.1 Calibrate Touchscreen on page 74.

F.3 USB Memory Stick does not work

There are a few unsupported memory sticks available on the market. Please use another model or brand and try again.

F.4 Cannot switch off the CAPO

Disconnect the power cable and press the Power switch for 15 seconds.



NOTE:

The CAPO is designed to be trouble free.
If problems or questions do arise please contact your nearest representative or our service support group in Switzerland.



G Warranty Conditions

Raytech GmbH Switzerland shall at their option and expense, repair, replace any part or parts that may prove to be defective within the warranty limitation period- irrespective of the operating time of the test equipment provided that the cause of the defect occurred prior to the time at which the risk was passed.

Warranty claims are subject to a warranty limitation period of 24 months from the date of shipment.

The purchaser is obligated to immediately notify Raytech GmbH Switzerland in writing of any defects of the supplied test equipment.

Raytech GmbH Switzerland must always be given the opportunity to rectify a defect within a reasonable amount of time. The purchaser shall grant an adequate amount of time that the test equipment shall be repaired.

Raytech GmbH Switzerland covers the costs associated with the repair of the defect; Especially the costs for the material and work. Cost for shipping the faulty test equipment shall be borne by the purchaser. Raytech GmbH Switzerland shall not be liable for material damage, or financial loss due to the loss of production, loss of data, loss of information, data or interest, regardless of their legal basis.

Warranty claim rights on replacement parts as well as repair of defective parts shall expire after 12 months.

Warranty limitation period shall be extendable according to the price list. The purchaser has the right to extend the warranty period by purchasing additional warranty years.

Limitation of Warranty

The foregoing warranty shall not apply to defects resulting from improper and unauthorized modifications or misuse and abuse of the product, negligence, alteration, modification, faulty installation by the customer, customer's agents or employees. Attempted or actual dismantling, disassembling, service or repair by any person, firm, or corporation not specifically authorized in writing by Raytech GmbH Switzerland.

Defects caused by or due to handling by carrier, or incurred during shipment, trans-shipment, or other move. Inadequate maintenance by the customer, second source supplied software or interfacing, operation outside the environmental limits, or improper site preparation.

Exclusive remedies provided herein are the customer's sole and exclusive remedies.

Raytech Switzerland shall not be liable for any damages resulting from the use of this equipment whether direct, indirect, special, incidental, or consequential damages, or whether based on contract, tort, or any other legal theory.

NO OTHER WARRANTY IS EXPRESSED OR IMPLIED.



Arbitration

All disputes arising out of or in connection with the contract between the purchaser and Raytech GmbH Switzerland and including those regarding the legal validity of this contract and this arbitration clause shall be settled out of court and shall be referred to arbitration for final decision.

Any disputes between the purchaser and Raytech GmbH Switzerland shall be settled according to the rules of settlement and arbitration of the chamber of commerce in Zurich by one or more arbitrators appointed also according to the rules of arbitration of the chamber of commerce in Zurich Switzerland.



H Contacts

Raytech Switzerland

Raytech GmbH
Oberebenestrasse 11
5620 Bremgarten

Phone: +41 56 648 6010
Fax: +41 56 648 6011
Mail: welcome@raytech.ch
Web: www.raytech.ch

Your local Representative

Empty box for local representative information.