



pH 500 & mV 600 Series

Panel-mounted,
Microprocessor-based
pH and ORP Controllers

Instruction Manual

Dear Customer,
Thank you for choosing a HANNA product.

This instruction manual refers to the following products:

- pH 500111-α** pH controller with single setpoint, ON/OFF control, analog output
- pH 500112-α** pH controller with single setpoint, ON/OFF control, RS232 output
- pH 500121-α** pH controller with single setpoint, proportional and ON/OFF controls, analog output
- pH 500122-α** pH controller with single setpoint, proportional and ON/OFF controls, RS232 output
- pH 500211-α** pH controller with dual setpoint, ON/OFF control, analog output
- pH 500212-α** pH controller with dual setpoint, ON/OFF control, RS232 output
- pH 500221-α** pH controller with dual setpoint, proportional and ON/OFF controls, analog output
- pH 500222-α** pH controller with dual setpoint, proportional and ON/OFF controls, RS232 output
- mV 600111-α** ORP controller with single setpoint, ON/OFF control, analog output
- mV 600112-α** ORP controller with single setpoint, ON/OFF control, RS232 output
- mV 600121-α** ORP controller with single setpoint, proportional and ON/OFF controls, analog output
- mV 600122-α** ORP controller with single setpoint, proportional and ON/OFF controls, RS232 output

α = 1 means 115 Vac, 50/60 Hz power supply

α = 2 means 230 Vac, 50/60 Hz power supply

Please read this instruction manual carefully before using the instrument. It will provide you with all necessary information for a correct use of the controller.

If you need additional technical information, do not hesitate to e-mail us at tech@hannainst.com

These instruments are in compliance with **CE** directives.

All rights are reserved. Reproduction in whole or in part is prohibited without the written consent of the copyright owner.

TABLE OF CONTENTS

PRELIMINARY EXAMINATION	4
GENERAL DESCRIPTION	4
FUNCTIONAL DESCRIPTION	6
MECHANICAL DIMENSIONS	7
SPECIFICATIONS pH 500 & mV 600	8
INSTALLATION	9
SETUP MODE	11
CONTROL MODE	17
IDLE MODE	22
ANALOG OUTPUT	23
RS 232 COMMUNICATION AND DATA LOGGING	25
CALIBRATION	27
LAST CALIBRATION DATA	39
STARTUP	42
FAULT CONDITIONS AND SELFTEST PROCEDURES .	43
pH VALUES AT VARIOUS TEMPERATURES	47
ELECTRODE CONDITIONING AND MAINTENANCE .	48
TAKING REDOX MEASUREMENTS	52
ACCESSORIES	54
WARRANTY	60
CE DECLARATION OF CONFORMITY	62

PRELIMINARY EXAMINATION

Remove the instrument from the packing material and examine it carefully to make sure that no damage has occurred during shipping. If there is any noticeable damage, notify your Dealer or the nearest Hanna Customer Service Center immediately.

Note Save all packing materials until you are sure that the instrument functions correctly. Any damaged or defective items must be returned in their original packing materials together with the supplied accessories.

GENERAL DESCRIPTION

The product is a real time microprocessor-based pH/ORP controller. It provides accurate measurements, flexible ON/OFF or proportional control capabilities and dual alarm signals.

The system is composed of a case inside which the signal conversion circuitry, the microprocessor circuitry and the output power drivers are contained.

MAIN FEATURES OF DIFFERENT MODELS

- Display: large LCD with 4½ 17 mm digits and 3 ½ 10 mm digits.
- LEDs: three (mV 600) or four (pH 500) LEDs are provided for signaling the energizing of relay 1 (a yellow led), relay 2 (a yellow led in pH 500 Series only) and alarm relays (a green and a red LED).
- Relays: 1 or 2 output relays for acid or base dosage (COM, NO and NC contacts) and 1 output relay for alarm condition (COM, NO and NC contacts).
- RS232 isolated communication link (optional).
- Calibration and Setup procedures allowed only through an unlock password.
- Calibration: for pH 500 Series in 1, 2 or 3 points with buffers 4.01, 7.01 and 10.01 pH (25 °C); for mV 600 Series in 1 or 2 points at 0, 350 and 1900 mV.
- Temperature compensation of the HANNA standard buffers (for pH 500 Series only).

- Temperature compensation of the pH reading (for pH 500 Series only).
- Manual temperature setting when the temperature probe is not inserted or temperature exceeds the upper range.
- Last calibration data internally recorded (non-volatile EEPROM memory): calibration date and time, pH offset, pH slopes, number of calibration points and correspondent pH values (for pH 500 Series only) or calibration date and time and the mV calibration points used (for mV 600 Series only).
- Input: pH electrode with BNC connector.
- Output:
 - isolated 0-1 mA, 10 K Ω maximum load (optional);
 - isolated 0-20 mA, 750 Ω maximum load (optional);
 - isolated 4-20 mA, 750 Ω maximum load (optional);
 - isolated 0-5 Vdc, 1 K Ω minimum load (optional);
 - isolated 1-5 Vdc, 1 K Ω minimum load (optional);
 - isolated 0-10 Vdc, 1 K Ω minimum load (optional).
- Real time clock.

FUNCTIONAL DESCRIPTION

FRONT PANEL

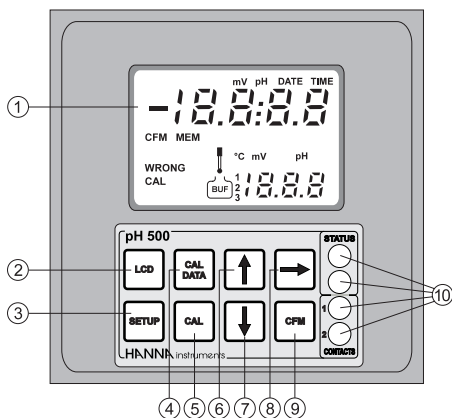

1. Liquid Crystal Display
2. LCD key exits from setup and calibration modes and reverts back to normal mode (in idle or control phases with the measurement on the display). In pH 500 series, during pH calibration, alternately displays pH buffer value or current temperature
3. SETUP key enters setup mode
4. CAL DATA key last calibration data viewing (enters and exits)
5. CAL key initiates and exits calibration mode
6. □ key increases the blinking digit/letter by one when selecting a parameter. Advances forward while in last calibration data viewing mode. Increases the temperature setting when temperature probe is not inserted
7. □ key decreases the blinking digit/letter by one when selecting a parameter. Reverts backward while in last calibration data viewing mode. Decreases the temperature setting when temperature probe is not inserted
8. □ key moves to the next digit/letter (circular buffer) when selecting a parameter. Same as □ key during last calibration data viewing mode
9. CFM key confirms current choice (and skips to the next item)
10. LEDs

REAR PANEL

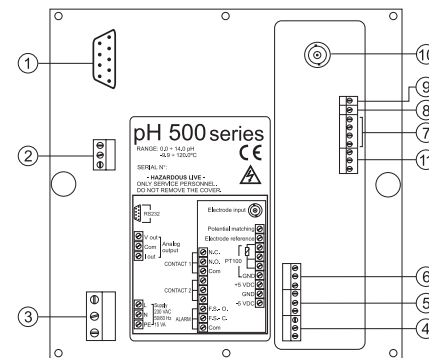

1. RS232 Connection Port (pH500XY2 and mV600XY2 models only)
2. Analog Output (pH500XY1 and mV600XY1 models only)
3. Power Supply Input
4. Alarm Terminal
5. Relay 2 - Second Dosing Terminal (pH5002XY models only)
6. Relay 1 - First Dosing Terminal
7. Connections for Pt 100 Temperature Sensor
8. Connection for Electrode Reference
9. Connection for Potential Matching Pin
10. BNC Socket for pH or ORP Electrode
11. ±5V Power Supply Output

 Unplug the meter before starting any electrical connections.

MECHANICAL DIMENSIONS

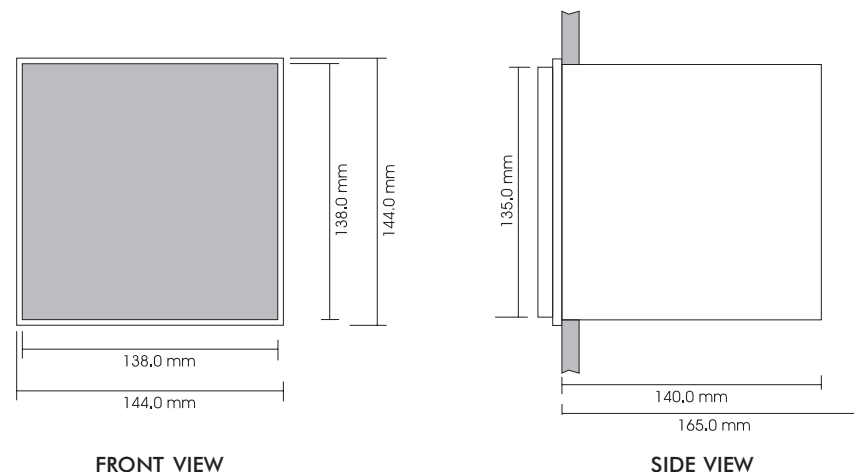

SPECIFICATIONS pH 500 & mV 600

Range	0.00 to 14.00 pH (pH 500 series only) ±2000 mV (mV 600 series only) -9.9 to 120.0 °C
Resolution	0.01 pH (pH 500 series only) 1 mV (mV 600 series only) 0.1 °C
Accuracy (@20°C/68°F)	±0.02 pH (pH 500 series only) ±2 mV (mV 600 series only) ±0.5 °C
Typical EMC Deviation	±0.2 pH (pH 500 series only) ±10 mV (mV 600 series only) ±0.5 °C
Calibration	pH: automatic, 1, 2 or 3 point, at pH 4.01, 7.01, 10.01 ORP: automatic, 2 point, at 0 and 350 or 1900 mV
Temperature Compensation (pH 500 series only)	automatic (with Pt100 probe) or manual, -9.9 to 120°C
Outputs	digital: RS232 bi-directional, optoisolated; or analog, galvanically isolated: 0-1 mA, 0-20 mA and 4-20 mA, 0-5 Vdc, 1-5 Vdc and 0-10 Vdc
Setpoint Relay	1 or 2 contact outputs SPDT, 5A-250 Vac, 5A-30 Vdc (resistive load). Fuse protected: 5A, 250V FUSE
Alarm Relay	1 contact output SPDT, 5A-250 Vac, 5A-30 Vdc (resistive load). Fuse protected: 5A, 250V FUSE
Installation Category	II
Power Supply	230 ±10% VAC or 115 ±10% VAC, 50/60 Hz
Power Consumption	15 VA
Over Current Protection	400 mA 250V FAST FUSE
Max. Oscillation Frequency	4 MHz
Environment	0 to 50°C (32 to 122°F); RH max 95%
Enclosure	single case ½ DIN
Dimensions	panel cutout: 140 x 140 mm instrument: 144 x 144 x 170 mm
Weight	approximately 1.6 kg. (3.5 lb.)

INSTALLATION

pH 500 and mV 600 offer a multitude of possibilities, from single and dual set-points to ON/OFF or proportional dosage, isolated outputs with user-selectable zoom, bi-directional RS232, recorder outputs in mAmps and volts.

In addition, pH 500 and mV 600 are both equipped with the exclusive differential input.

In a system with poor grounding, it is possible to have a ground current flowing through the reference junction. This can cause a rapid degradation of the electrode. The Hanna differential input reduces the likelihood of ground loops.

See the diagram for a recommended installation.

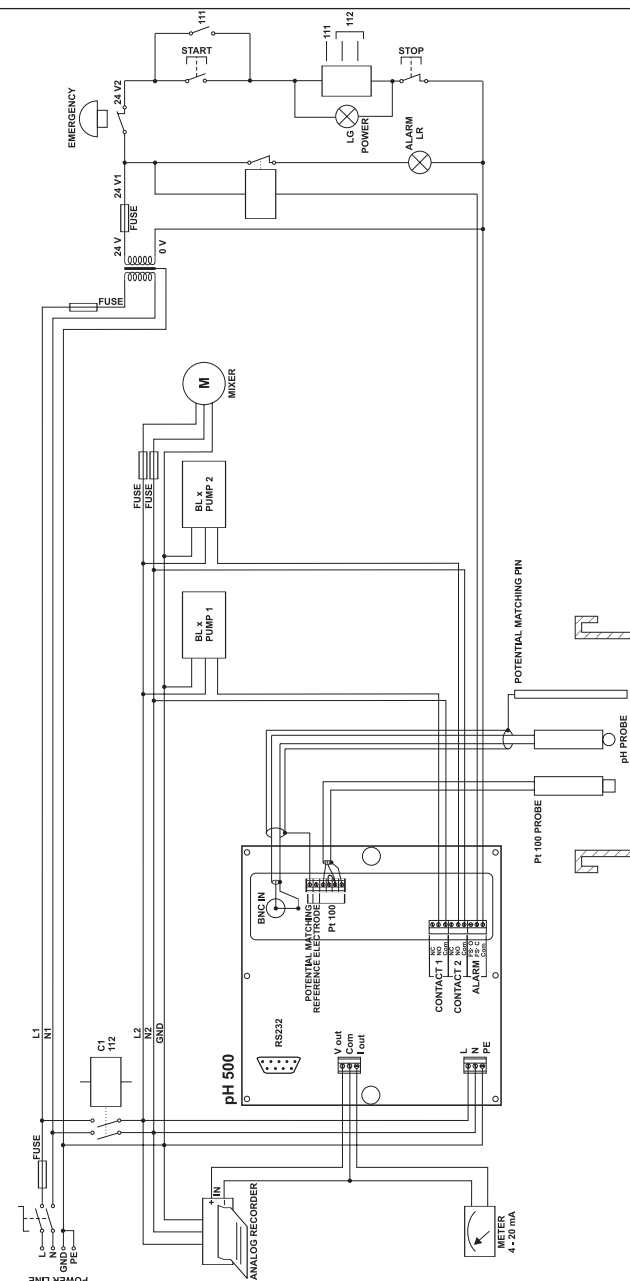

- Power Supply: Connect a 3-wire power cable to the terminal strip, while paying attention to the correct line (L), earth (PE) and neutral (N) terminal connections.



Power: 115VAC - 100 mA / 230VAC - 50 mA

Line Contact: fused inside 400 mA.

PE must be connected to ground; leakage current 1 mA.

- Electrode: Connect the pH or ORP electrode to the BNC socket (#10 at page 7). To benefit from the differential input, connect the proper electrode wire (if available) or a cable with a potential matching pin (grounding bar) to the relevant terminal (#9 at page 7).



Note When it is not possible to immerse the Potential Matching Pin together with the pH electrode in the solution, disable the differential input by connecting the Connection for Potential Matching Pin (#9 at page 7) with the Connection for Electrode Reference (#8 at page 7) with a jumper wire.



- Pt 100 Terminals: these contacts (#7 at page 7) connect the Pt 100 temperature sensor for automatic temperature compensation of pH measurement. In the case of shielded wire, connect the shield to pin 4.

In the case of a 2-wire sensor connect the Pt 100 to pins 1 and 3, and short pins 2 and 3 with a jumper wire.

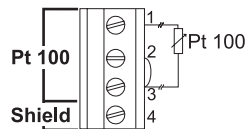

If the Pt 100 has more than 2 wires, connect the two wires of one end to pins 2 and 3 (pin 2 is an auxiliary input to compensate for the cable resistance) and one wire from the other end to pin 1. Leave the fourth wire unconnected, if present.

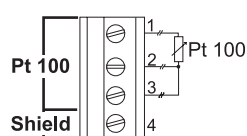

- Power Supply Output: these terminals provide +5 Vdc and -5 Vdc signals to supply power to amplified electrodes.

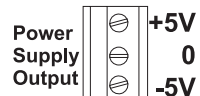

Note All cables connected to rear panel should end with cable lugs.

SETUP MODE

pH 500 and mV 600 offer a multitude of possibilities from ON/OFF or proportional dosage to analog recorder output and from alarm to selftest features.

The Setup Mode allows the user to set all needed characteristics of the meter.

The setup mode is entered by pressing SETUP and entering the password when the device is in idle or control mode.



Generally speaking, if the password is not inserted the user can only view the setup parameters (except for password) without modifying them (and the device remains in control mode). An exception is certain setup items, or flags, which can activate special tasks when set and confirmed.

Each setup parameter (or setup item) is assigned a two-digit setup code which is entered and displayed on the secondary LCD.

The setup codes can be selected after password and CFM are pressed. When CFM is pressed, the current setup item is saved on EEPROM and the following item is displayed.

Whenever LCD is pressed, the device reverts back to control mode. The same is true when CFM is pressed on the last setup item.



The possible transitions in setup mode are the following:

ENTERING THE PASSWORD

- Press SETUP to enter the setup mode. The LCD will display "0000" on the upper part and "PAS" on the lower. The first digit of the upper part of the LCD will blink.

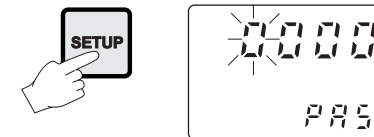

- Enter the first value of the password by the \uparrow or \downarrow keys.



- Then confirm the displayed digit with  and move to the next one.

- When the whole password has been inserted, press CFM to confirm it.

Note The default password is set at "0000".

- The LCD will display "SET" on the upper part and "c.00" on the lower, allowing the user to edit setup parameters (see table below).

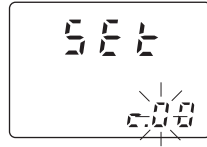

- Enter the code of the parameter you want to set, using the arrow keys as per the password procedure above (e.g.41).
- Confirm the code by pressing CFM and the default or the previously memorized value will be displayed with the first digit blinking.

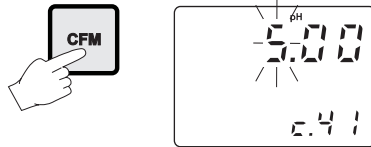

Note When the password is not inserted or a wrong password is confirmed, the display will only show the previously memorized value, without blinking (read only mode). In this case, the value cannot be set. Press LCD and start again.

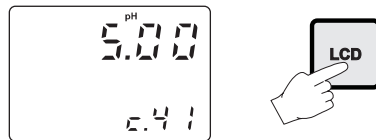

- Enter the desired value using the arrow keys and then press CFM.

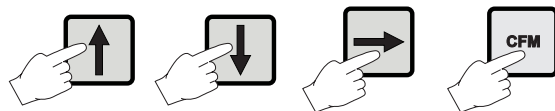

- After confirmation, the selected parameter is displayed. The user can scroll through the parameters by pressing CFM.

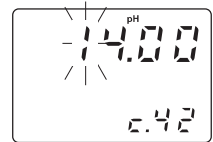

In order to directly set another parameter, press SETUP again and enter the code or scroll to it by pressing CFM.



The following table lists the setup codes along with the description of the specific setup items, their valid values and whether password is required to view that item ("PW" column):

Code	Valid Values	Default	PW
00 Factory ID	0 to 9999	0000	no
01 Process ID	0 to 9999	0000	no
02 Control enable/disable	0: C.M. disabled 1: C.M. enabled	0	no
11 Relay 1 mode (M1)	0: disabled 1: ON-OFF high setpoint 2: ON-OFF low setpoint 3: Proportional, high setpoint 4: Proportional, low setpoint	0	no
12 Relay 1 setpoint (S1)	0.00 to 14.00 pH -2000 to 2000 mV	8.00 pH 500 mV	no
13 Relay 1 hysteresis (H1)	0.00 to 14.00 pH 0 to 4000 mV	1 pH 50 mV	no
14 Relay 1 deviation (D1)	0.50 to 14.00 pH 25 to 4000 mV	1 pH 50 mV	no
21* Relay 2 mode (M2)	same as relay 1	0	no
22* Relay 2 setpoint (S2)	0.00 to 14.00 pH -2000 to 2000 mV	6.00 pH -500 mV	no
23* Relay 2 hysteresis (H2)	0.00 to 14.00 pH 0 to 4000 mV	1 pH 50 mV	no
24* Relay 2 deviation (D2)	0.50 to 14.00 pH 25 to 4000 mV	1 pH 50 mV	no

* Available only in models with two relays

Code	Valid Values	Default	PW
30 Relay 3 high alarm (HA)	0.00 to 14.00 pH -2000 to 2000 mV HA > LA, HA ≥ S1 or HA ≥ S2	9.00 pH 600 mV	no
31 Relay 3 low alarm (LA)	0.00 to 14.00 pH -2000 to 2000 mV LA < HA, LA ≤ S1 or LA ≤ S2	5.00 pH -600 mV	no
32 Proportional control mode period	1 to 30 min	5	no
33 Maximum relay ON time (after which an alarm mode is entered)	10 to 9999 min	60	no
40 Analog output selection	0: 0-1 mA 1: 0-20 mA 2: 4-20 mA 3: 0-5 VDC 4: 1-5 VDC 5: 0-10 VDC	2	no
41 Analog output lower limit (O_VARMIN)	0.00 to 13.00 pH -2000 to 2000 mV (O_VARMIN < O_VARMAX - (1.00pH or 50mV))	0.00 pH -2000 mV	no
42 Analog output upper limit (O_VARMAX)	1.00 to 14.00 pH -2000 to 2000 mV (O_VARMIN < O_VARMAX - (1.00pH or 50mV))	14.00 pH 2000 mV	no
60 Current day	01 to 31	from RTC	no
61 Current month	01 to 12	from RTC	no
62 Current year	1997 to 9999	from RTC	no
63 Current time	00:00 to 23:59	from RTC	no
71 Baud rate	1200, 2400, 4800, 9600	4800	no
90 Display selftest 1: on	0: off	0	yes
91 Keyboard selftest	0: off 1: on	0	yes

Code	Valid Values	Default	PW
92 EEPROM selftest	0: off 1: on	0	yes
93 Relays and LEDs selftest	0: off 1: on	0	yes
94 Watchdog selftest	0: off 1: on	0	yes
99 Unlock password	0000 to 9999	0000	yes

Note

The process controller automatically checks to ensure that the entered data matches other related variables. If a wrong configuration is entered, "WRONG" blinks on the LCD to prompt the user. The correct configurations are the following:

If M1 ≠ 0 then S1 ≤ HA, S1 ≥ LA;

If M2 ≠ 0 then S2 ≤ HA, S2 ≥ LA;

If M1 = 1 then S1 - H1 ≥ LA;

If M1 = 2 then S1 + H1 ≤ HA;

If M1 = 3 then S1 + D1 ≤ HA;

If M1 = 4 then S1 - D1 ≥ LA;

If M2 = 1 then S2 - H2 ≥ LA;

If M2 = 2 then S2 + H2 ≤ HA;

If M2 = 3 then S2 + D2 ≤ HA;

If M2 = 4 then S2 - D2 ≥ LA;

If M1 = 1 and M2 = 2
then S1 - H1 ≥ S2 + H2, S2 ≥ LA, HA ≥ S1;

If M1 = 2 and M2 = 1
then S2 - H2 ≥ S1 + H1, S1 ≥ LA, HA ≥ S2;

If M1 = 3 and M2 = 2
then S1 ≥ S2 + H2, S2 ≥ LA, HA ≥ S1 + D1;

If M1 = 2 and M2 = 3
then S1 + H1 ≤ S2, S1 ≥ LA, HA ≥ S2 + D2;

If M1 = 4 and M2 = 1
then S1 ≤ S2 - H2, S1 - D1 ≥ LA, HA ≥ S2;

If M1 = 1 and M2 = 4
then S1 - H1 ≥ S2, S2 - D2 ≥ LA, HA ≥ S1;

If M1 = 3 and M2 = 4

then $S1 \geq S2$, $S2 - D2 \geq LA$, $HA \geq S1 + D1$;
 If $M1 = 4$ and $M2 = 3$
 then $S2 \geq S1$, $S1 - D1 \geq LA$, $HA \geq S2 + D2$;
 where the minimum deviation ($D1$ or $D2$) is 0.5 pH (for pH 500) or 25 mV (for mV 600).

Note The password cannot be viewed when SETUP is pressed without entering the original password first. The default password is set at "0000". In the event that the user forgets the password, this can be reset to "0000" by pressing and holding CFM and then pressing LCD and CAL DATA at the same time when the pH controller is in normal operating mode (idle or control with measurement displaying).



Note When a wrong setup value is confirmed, the pH controller does not skip to the next setup item but remains in the current item displaying a flashing "WRONG" indicator until the parameter value is changed by the user (the same is also true for the setup code selection). In some circumstances, user cannot succeed in setting a parameter to a desired value if the related parameters are not changed beforehand; e.g. to set a pH high setpoint to 10.00 the high alarm must be set to a value greater than pH 10.00 first.

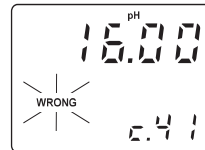

Note For code numbers 40, 41, 42, the output is related to pH or mV units depending on the model (pH process meters or mV process meters).

CONTROL MODE

The control mode is the normal operational mode for these meters. During control mode pH 500 and mV 600 fulfill the following main tasks:

- convert information from pH/ORP and temperature inputs to digital values;
- control relays and generate the analog outputs as determined by the setup configuration, display alarm condition;
- RS232 management.

In addition, pH 500 and mV 600 can log working data through RS232 connection. This data includes:

- pH, mV and °C measured values;
- last calibration data;
- setup configuration (also from PC).

The status of the meter is shown by the LED's on the right

STATUS	LEDs			
	Control	Alarm	Alarm LED (green)	Relay LED (yellow)
OFF	---	ON	OFF	ON
ON	OFF	ON	ON or OFF	OFF
ON	ON	OFF	ON or OFF	Blinking

Meter exits control mode by pressing SETUP or CAL and confirming the password. Note that this command generates a temporary exit. To deactivate the control mode definitively, set CONTROL ENABLE to "0" (item # 02).

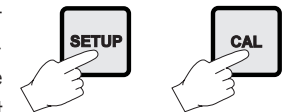

RELAY MODES

Once enabled, the relays 1 and 2 can be used in four different modes:

- 1) ON/OFF, high setpoint (acid dosage);
- 2) ON/OFF, low setpoint (base dosage);
- 3) proportional, low setpoint (base dosage, if available);
- 4) proportional, high setpoint (acid dosage, if available).

An upper boundary is imposed for acid/base dosage time when relays are energized continuously, i.e. when relay works in ON/OFF mode or in proportional mode but in the latter case only if the relay is always ON. This parameter can be set through setup procedure. When the maximum boundary is reached, an alarm is generated; device stays in alarm condition until relay is de-energized.

ON/OFF CONTROL MODE

Either for mode 1 or 2 (base or acid dosage) the user has to define the following values through setup:

- relay setpoint (pH/mV value);
- relay hysteresis (pH/mV value).

Connect your device to the COM and NO (Normally Open) or NC (Normally Closed) terminals.



The ON relay state occurs when relay is energized (NO and COM connected, NC and COM disconnected).

The OFF relay state occurs when relay is de-energized (NO and COM disconnected, NC and COM connected).

The following graphs show relay states along with pH measured value (similar graph can be derived for mV control).

As shown below, a high setpoint relay is activated when the measured pH exceeds the setpoint and is deactivated when it is below the setpoint value minus hysteresis.

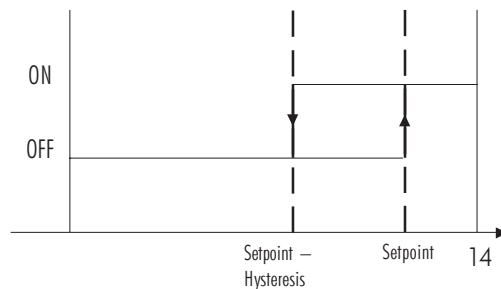

Such a behavior is suitable to control an acid dosing pump. A low setpoint relay as can be seen from the following graphs is energized when the pH value is below the setpoint and is de-energized when the pH value is above the sum of setpoint and the hysteresis. The low setpoint relay may be used to control an alkaline dosing pump.

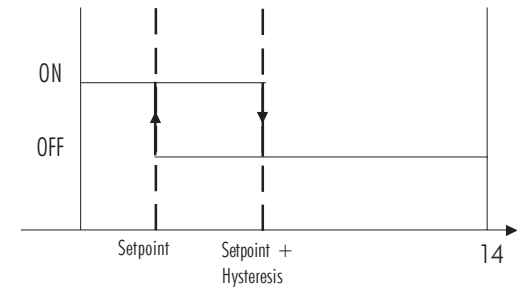

PROPORTIONAL CONTROL MODE

The user can vary three different parameters, i.e. the setpoint (S1 or S2), the deviation (D1 or D2) and the proportional control mode period T_c from 1 to 30 minutes. Duration of the activated control is directly proportional to the error value (Duty Cycle Control Mode): as the measurement approaches setpoint, the ON period diminishes.

The following graph describes the pH process controller behavior. Similar graph may apply to the mV controller.

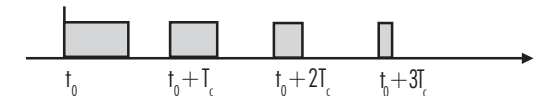

During proportional control the process controller calculates the relay activation time at certain moments t_0 , $t_0 + T_c$, $t_0 + 2T_c$ etc. The ON interval (the shaded areas) is then proportional to the error amplitude.

For example with S1 representing High Setpoint

Setpoint (S1) = 7.00 pH

Deviation (D1) = 1.00 pH

$T_c = 1$ minute

If measurement ≥ 8.00 pH, then ON all the time.

If measurement = 7.60 pH, then ON for 36 seconds
OFF for 24 seconds.

If measurement = 7.10 pH, then ON for 6 seconds
OFF for 54 seconds.

The number of strokes per minute of the pump can be changed only by means of the pump's command.

Referring to the following diagram (low setpoint) the relay is:

- ALWAYS ON if $\text{pH} < \text{setpoint} - \text{deviation}$;
- ON proportionally to the error if $\text{setpoint} - \text{deviation} < \text{pH} < \text{setpoint}$

- ALWAYS OFF if pH > setpoint;

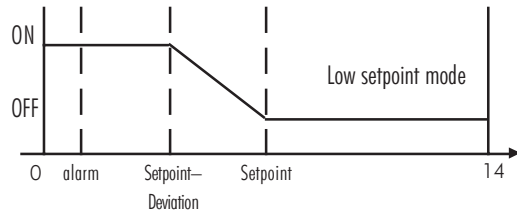

Using a similar format, the second relay may be set up according to the diagram below.

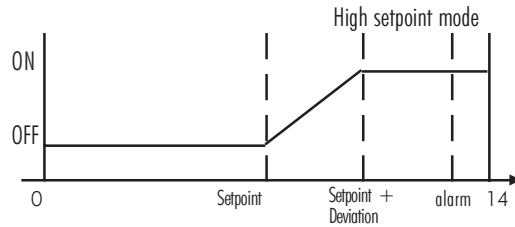

ALARM RELAY

The alarm relay functions in the following manner:

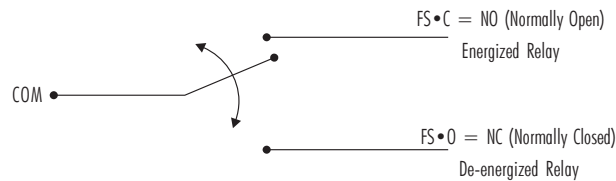

During alarm condition, the relay is de-energized. When not in alarm condition, the relay is energized.

Example: High alarm set at 10 pH
Low alarm set at 4 pH

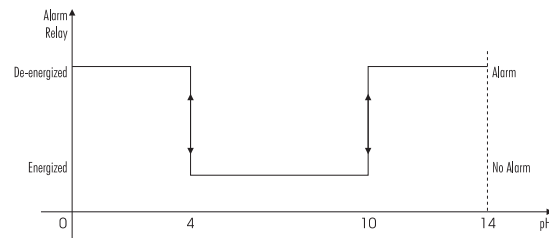

Note If the power supply is interrupted, the relay is de-energized as if in alarm condition to alert the operator.

In addition to the user-selectable alarm relays, all pH 500 and mV 600 models are equipped with the **Fail Safe** alarm feature.

The **Fail Safe** feature protects the process against critical errors arising from power interruptions, surges and human errors. This sophisticated yet easy-to-use system resolves these predicaments on two fronts: hardware and software. To eliminate problems of blackout and line failure, the alarm function operates in a "Normally Closed" state and hence alarm is triggered if the wires are tripped, or when the power is down. This is an important feature since with most meters the alarm terminals close only when an abnormal situation arises, however, due to line interruption, no alarm is sounded, causing extensive damage. On the other hand, software is employed to set off the alarm in abnormal circumstances, for example, if the dosing terminals are closed for too long a period. In both cases, the red LED's will also provide a visual warning signal.

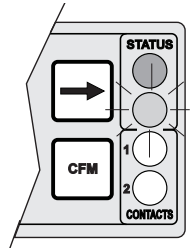

The Fail Safe mode is accomplished by connecting the external alarm circuit between the FS•C (Normally Open) and the COM terminals. This way, an alarm will warn the user when pH goes over the alarm thresholds, the power breaks down and in case of a broken wire between the process meter and the external alarm circuit.

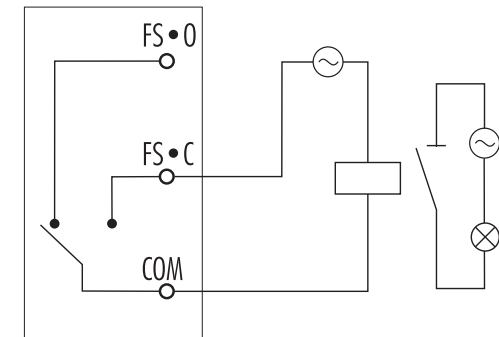

Note In order to have the Fail Safe feature activated, an external power supply has to be connected to the alarm device.

IDLE MODE

During idle mode the device performs the same tasks as when it is in control mode except for the relays. The alarm relay is activated (no alarm condition), the acid and base relays are not activated while the analog output remains activated.

When the instrument is in idle mode the red and green status LEDs are on.

Idle mode is useful to disable control actions when the exter-

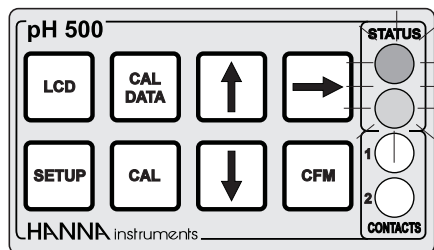

nal devices are not installed or when the user detects unusual circumstances.

Control actions are stopped as soon as the user presses SETUP and enters the password.

In order to reactivate the control mode, use code 02 of setup (see "Setup" section). Otherwise, the meter remains in idle mode.



ANALOG OUTPUT

All models pH 500XY1 and mV 600XY1 are provided with the analog output feature.

The output is isolated and can be a voltage or a current.

With the recorder, simply connect the common port to the ground output and the second port to the current output or voltage output (depending on which parameter is being used) as depicted aside.

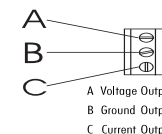

The type (voltage or current) and the range of the output analog signal is selectable through the jumpers on the power board.

Configurations of the switch are as follows:

Output	Switch 1	Switch 2	Switch 3	Switch 4
0-5 Vdc, 1-5 Vdc	OFF	ON	--	--
0-10 Vdc	ON	OFF	--	--
0-20 mA, 4-20 mA	--	--	ON	--
0-1 mA	--	--	OFF	--

Choice between different ranges with the same configuration (for example 0-20 mA and 4-20 mA) is achieved via software by entering the setup mode and selecting code 40 (see Setup Mode section for exact procedure).

Factory default is switches 1 and 3 closed (ON) and switches 2 and 4 open (OFF), i.e. 0-20 mA, 4-20 mA, and 0-10 Vdc.

In any case, contact the nearest Hanna Customer Service Center for changing of the default configuration.

By default the minimum and maximum values of analog output correspond to the minimum and maximum of the range of the meter. For example, for the pH 500 series with a selected analog output of 4-20 mA, the default values are 0.00 and 14.00 pH corresponding to 4 and 20 mA, respectively.

These values can be changed by the user to have the analog output matches a different pH range, for example, 4 mA = 3.00 pH and 20 mA = 5.00 pH.

To change the default values, the setup mode must be entered. Setup codes for changing the analog output minimum and maximum are 41 or 42, respectively. For the exact procedure, refer to the setup mode section in the manual.

Note The difference between maximum and minimum values for the analog output must be at least 1.00 pH or 50 mV.

Note The analog output is factory calibrated through software. The user may also perform these calibration procedures following the procedure at page 36. It is recommended to perform the output calibration at least once a year.

RS232 COMMUNICATION AND DATA LOGGING

All models pH 500XY2 and mV 600XY2 are provided with an RS232 port.

Data transmission from the instrument to the PC is possible with the **HI 92500** Windows® compatible software by Hanna Instruments.

The user-friendly **HI 92500** offers a variety of features such as logging selected variables or plotting the recorded data. It also has an on-line help feature to support you throughout the operation.

HI 92500 makes it possible for you to use the powerful means of the most diffused spreadsheet programs (Excel®, Lotus 1-2-3® etc.). Simply run your favorite spread sheet and open the file downloaded by **HI 92500**. It is then possible to elaborate the data with your software (e.g. graphics, statistical analysis).

To install **HI 92500** you need a 3.5" drive and few minutes to follow the instructions conveniently printed on the disk's label.

Contact your Hanna Dealer to request a copy.

ELECTRICAL CONNECTIONS

To connect your Hanna meter to a PC use an **HI 920010** cable.

Make sure that your meter is switched off and plug the connectors, one to the meter RS232 connector and the other to the serial port of your PC.

If your interface does not fully comply with the RS232 standard, wiring could be different.

The GND pin of the interface connector and all the interface signals are optoisolated from the ground of the instrument, the pH electrode and the temperature sensor.

Before connecting the meter to the computer, consult the computer manual.

Note Cables other than **HI 920010** may use a different configuration. In these cases, no communication between the meter and the PC is possible. If you are not using the **HI 920010** cable, contact the nearest Hanna Customer Service Center or proceed as follows for a proper electrical connection:

pH 500/mV 600 9-pin DSUB male connector	PC 9-pin DSUB female connector
Pin 2	Pin 3 (Txd)
Pin 3	Pin 2 (Rxd)
Pin 4	Pin 6 (Txd)
Pin 5	Pin 5 (Gnd)
Pin 6	Pin 4 (DTR)
Pin 7 short circuit with 8 (RTS+CTS)	

pH 500/mV 600 9-pin DSUB male connector	PC 25-pin DSUB female connector
Pin 2	Pin 2 (Txd)
Pin 3	Pin 3 (Rxd)
Pin 4	Pin 6 (Txd)
Pin 5	Pin 7 (Gnd)
Pin 6	Pin 20 (DTR)
Pin 4 short circuit with 5 (RTS+CTS)	

SETTING THE BAUD RATE

The transmission speed (baud rate) of the meter and the external device must be identical.

The meter is factory set to 4800. If you wish to change this value, use item 71 in the setup mode (see page 14).

Excel® Copyright of "Microsoft Co."

Lotus 1-2-3® Copyright of "Lotus Co."

Windows® and Windows Terminal® are registered Trademark of "Microsoft Co."

CALIBRATION

The controller is factory calibrated for mV and temperature inputs as well as for the analog outputs.

The user should periodically calibrate the instrument. For greatest accuracy, it is recommended that the instrument is calibrated frequently.

It is possible to standardize the electrode with only one buffer, preferably close to the expected sample value (one-point calibration), but it is always good practice to calibrate in at least 2 points.

pH CALIBRATION (for pH 500 Series only)

The pH controller can be calibrated through a one-point, two-point or three-point calibration. You do not need to enter the method chosen, simply exit the calibration mode, by pressing CAL, when the desired number of points has been calibrated.



The calibration points for pH 500 are pH 4.01, pH 7.01 and pH 10.01 (at 25°C). The sequence proposed by the controller is pH 7.01, pH 4.01, pH 10.01. However, the user can change this sequence by means of the \square and \square keys.

The electrode must be kept hydrated at all times and definitely prior to calibration. The temperature probe should also be connected to the process meter. The meters are equipped with a stability indicator. The user is also guided with indications on the display during the calibration procedure.

Initial Preparation

Pour small quantities of pH 7.01 (**HI 7007**) and pH 4.01 (**HI 7004**) and/or pH 10.01 (**HI 7010**) solutions into individual beakers. If possible, use plastic beakers to minimize any EMC interference.



For accurate calibration, use two beakers for each buffer solution, the first one for rinsing the electrode, the second one for calibration. By doing this, contamination between the buffers is minimized.

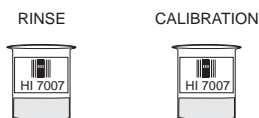

To obtain accurate readings, use pH 7.01 and pH 4.01 if you measure acidic samples, or pH 7.01 and pH 10.01 for alkaline measurements or perform a 3-point calibration for the entire range.

One Point Calibration (Offset)

- To perform the pH calibration enter the calibration mode, by pressing CAL and entering the password.
- After the correct password is entered, the control actions stop and the primary LCD will display the pH value using the current offset and slope, with the "CAL" and "Buf" indicators lit and the probe indicator "pH" blinking. The value displayed on the secondary LCD is the buffer value at the actual temperature.

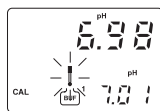

Note The actual pH value varies with temperature, thus the calibration value displayed on the secondary LCD will vary around pH 4.01, 7.01 and 10.01 with temperature changes: for example at 25 °C the display shows 4.01 - 7.01 - 10.01, at 20 °C it shows 4.00 - 7.03 - 10.06 (see page 47 for other values).

- pH 7.01 is the default value for the 1st calibration buffer. If a different value is needed, select it on the secondary display by pressing \uparrow or \downarrow .



Note If the wrong password is entered the system reverts back and restarts displaying the pH value.

- Remove the protective cap from the pH electrode and immerse it into the selected buffer solution (e.g. pH 7.01) with the Potential Matching Pin and temperature probe, then stir gently.

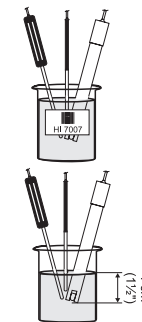

Note The electrode should be submerged approximately 4 cm (1 1/2") in the solution. The temperature probe should be located as close as possible to the pH electrode.

Note When it is not possible to immerse the Potential Matching Pin together with the pH electrode in the solution, disable the differential input by connecting the Connection for Potential Matching Pin (#9 at page 7) with the Connection for Electrode Reference (#8 at page 7) with a jumper wire.

- Only when the reading is stable the probe indicator "pH" will stop flashing (after about 30 seconds) and the "CFM" indicator will start blinking.

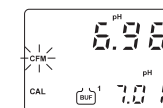

- Press CFM to confirm the calibration; if the reading is close to the selected buffer (± 1.5 pH), the meter stores the reading and the secondary LCD will display the expected second buffer value. Offset and slope calculation is made at the end by pressing CAL to exit.

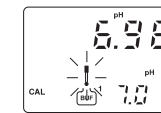

If the reading is not close to the selected buffer, "WRONG" will blink.

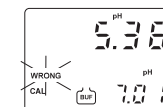

- If CAL is pressed, the calibration process ends by memorizing a new offset value. The new offset value is stored and a default value of 57.5 mV per pH unit at 25°C is assigned as the new slope value.



For best accuracy however, it is recommended that a two-point calibration is performed.

Two-point Calibration

- Proceed as described above for one-point calibration, using pH 7.01 as the first point, but do not quit calibration by pressing CAL at the end.



Note The meter will automatically skip the buffer that was used for the first calibration to prevent errors.

- After the first calibration point is confirmed, immerse the pH electrode with the Potential Matching Pin into the second buffer (e.g. pH 4.01) and stir gently

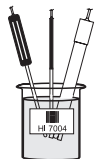

Note If you are not going to perform a three-point calibration, it is recommendable to use pH 4.01 buffer if you are going to measure acid samples, or use pH 10.01 buffer for alkaline samples.

Note The electrode should be submerged approximately 4 cm (1 1/2") in the solution. The temperature probe should be located as close as possible to the pH electrode.

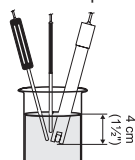

- Select the 2nd buffer value on the secondary display by pressing \uparrow or \downarrow (e.g. pH 4.01).
- Only when the reading is stable the probe indicator "||" will stop flashing (after about 30 seconds) and the "CFM" indicator will blink.
- Press CFM to confirm the calibration; if the reading is close to the selected buffer, the meter stores the reading, adjusting the slope point and the secondary LCD will display the expected third buffer value.

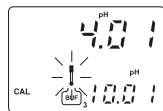
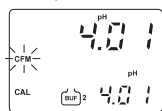

If the reading is not close to the selected buffer, "WRONG" will blink.

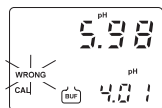

- Press CAL and the calibration process is ended with the offset and the 1st slope of the meter calibrated.



Three-point Calibration

- Proceed as described above but do not quit calibration by pressing CAL.



Note The meter will automatically skip the two buffers that were used to prevent errors.

- After the second calibration point is confirmed, immerse the pH electrode and the Potential Matching Pin into the third buffer solution (e.g. pH 10.01) and stir gently.



Note The electrode should be submerged approximately 4 cm (1 1/2") in the solution. The temperature probe should be located as close as possible to the pH electrode.

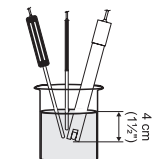

- Only when the reading is stable the probe indicator "||" will stop flashing (after about 30 seconds) and the "CFM" indicator will start blinking.
- Press CFM to confirm the calibration; if the reading is close to the selected buffer, the meter stores the reading, adjusting the 2nd slope point and the calibration process is ended with the offset and the 1st and 2nd slope of the meter calibrated.

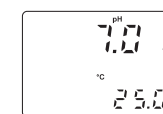
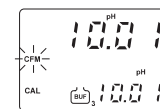

If the reading is not close to the selected buffer, "WRONG" will blink.

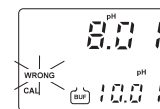

Note During calibration, the secondary LCD displays the selected buffer value. By pressing LCD the temperature can be displayed. This will allow you to check the buffer temperature during calibration.

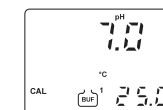

CALIBRATION WITH MANUAL TEMPERATURE COMPENSATION

- Enter the calibration procedure and press LCD to display the temperature on the secondary LCD.

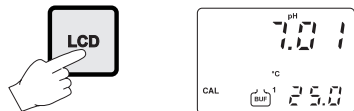

- Unplug any temperature probe that may be attached to the meter. The "°C" symbol will flash.
- Note the temperature of the buffer solutions with a ChecktempC or an accurate thermometer with a resolution of 0.1°C.
- Use \uparrow or \downarrow to manually adjust the display reading to the value of the reference thermometer (e.g. 20°C).

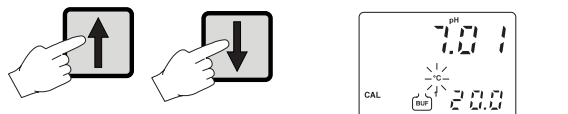

- Follow the calibration procedure above (see page 27).

Note To toggle between the pH buffer and the temperature press LCD.



When a one-point calibration is carried out only the pH offset is computed and stored, while the pH slope is fixed according to the theoretical values.

With a two-point calibration, offset and slope are computed to fit the two calibration points. With a three-point calibration the offset and first slope values refers to pH 4.01 and 7.01 buffers, while the second slope refers to pH 7.01 and 10.01 buffers.

Note If the process meter has never been calibrated or an EEPROM reset has occurred, the meter continues to perform measurement. However, user is informed of a pH calibration requirement by a blinking "CAL" (see "Startup" section).

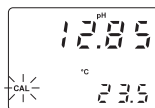

The device must be calibrated within the temperature range of 0-95°C. Outside this range, the buffer pH values are not reliable.

mV INPUT CALIBRATION

The pH/mV controller is factory calibrated for the mV and temperature inputs. However, the user may also perform a mV calibration.

- Short the Connection for Potential Matching Pin (#9 at page 7) and the Connection for the Electrode Reference (#8 at page 7) with a jumper wire.
- Attach a HI 931001 (pH 500) or HI 8427 (mV 600) simulator to the BNC socket.
- Press and hold first CFM and then CAL to enter the mV Input Calibration mode.
- Execute the password procedure.
- With **pH 500**, the meter will ask for the calibration procedure code number. The following table lists the possible values of the input code and calibration points:



INPUT	CODE	POINTS	CAL.VALUES	INPUT RANGE
mV	0	2	0 & 350 or 0 & 1900*	±2000,
Temp.	1	2	0 & 25 or 0 & 50	-9.9 to 120.0 °C

* One of the points must be 0. 1900 mV calibration point is available on mV 600 models only.

When calibrating the mV of mV 600 models, enter the calibration mode by pressing CAL and confirming the password (as for pH calibration of pH 500). No code selection is required.

- Use \uparrow or \downarrow to select code 0 for mV calibration and press CFM to enter.

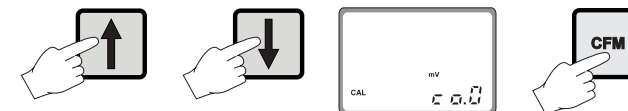

- CAL will blink on the LCD until the meter confirms a steady reading.

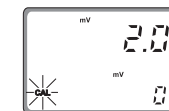

- When the reading has stabilized at a point near the first calibration point, CAL will stop blinking and an intermittent CFM icon will prompt the user to confirm the first calibration.

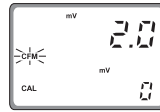

- If the display stabilizes at a value significantly different from the first setpoint, an intermittent WRONG icon will prompt the user to check and adjust the simulator and start again.

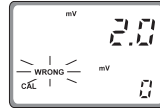

- After pressing CFM the unit will switch to the second calibration point at 350 mV.

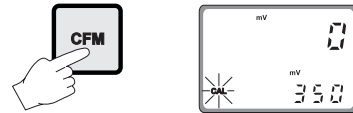

- With mV 600 it is possible to select 1900 mV by pressing \square or \square . After that, proceed as described above.

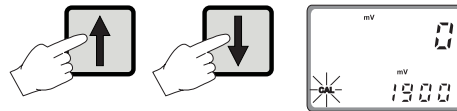

Note A measure is considered stable when it varies little within a sequence of acquisitions. The number of acquisitions is fixed so that the waiting time for blinking "CFM" is about 20 seconds.

Calibration procedure may be interrupted by pressing CAL. If the calibration procedure is interrupted this way, or if the controller is switched off before the last step, no calibration data is stored to EEPROM.



TEMPERATURE CALIBRATION

The pH/mV controller is factory calibrated for the mV and temperature inputs. However, the user may also perform a temperature calibration.

- Prepare a beaker containing ice and water at 0°C/32°F and another one with hot water at 25°C/77°F or 50°C/122°F.

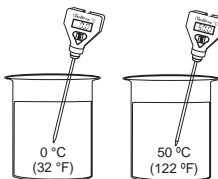

- Use a Checktemp or a calibrated thermometer with a resolution of 0.1° as a reference thermometer.

- Immerse the temperature probe in the beaker with ice and water as near to the Checktemp as possible.



- Press and hold first CFM and then CAL to enter the temperature calibration mode.

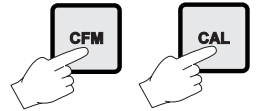

- Execute the password procedure.

- With pH 500, the meter will ask for the calibration procedure code number. Use \square or \square to select code 1 for the temperature calibration and press CFM to enter.

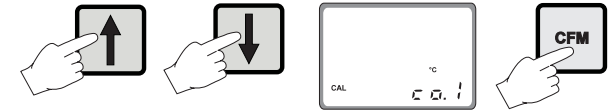

- CAL will blink on the LCD until the meter confirms a steady reading.

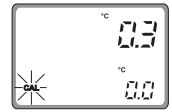

- When the reading has stabilized at a point near the first calibration point, CAL will stop blinking and an intermittent CFM will prompt the user to confirm the first calibration.

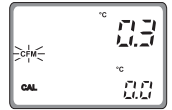

- If the reading stabilizes at a reading significantly variant from the first setpoint, an intermittent WRONG will prompt the user to check the beaker or baths.



- After pressing CFM the unit will switch to the second calibration point.



- Select 25 or 50°C by pressing \square or \square .



- Immerse the temperature probe in the second beaker as near to the Checktemp as possible and repeat the above procedure.



Calibration procedure may be interrupted by pressing CAL again at any time. If the calibration procedure is stopped this way, or if the controller is switched off before the last step, no calibration data is stored in non-volatile memory (EEPROM).

ANALOG OUTPUT CALIBRATION

In the meters where the analog output is available, this feature is factory calibrated through software. The user may also perform these calibration procedures.

IMPORTANT

It is recommended to perform the output calibration at least once a year. Calibration should only be performed after 10 minutes from power up.

- With a multimeter or an HI 931002 connect the common port to the ground output and the second port to the current output or voltage output (depending on which parameter is being calibrated).

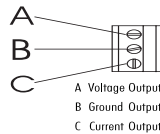

- Press and hold in sequence CFM first, then \rightarrow and then CAL to enter the Analog Output Calibration mode.

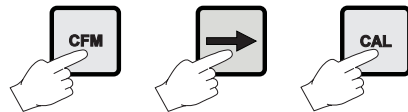

- Execute the password procedure.
- The primary display will show the current selected parameter blinking. Use the \uparrow to select the code (0-5 see chart below) for the desired parameter displayed on the secondary display (e.g. 4-20 mA).

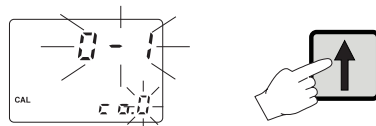

- Press CFM to confirm the selected parameter that will stop blinking on the primary display. The secondary display shows the HI 931002 or multimeter input value as lower limit of the interval.

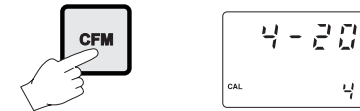

- Use the \uparrow or \downarrow to make the HI 931002 or multimeter output correspond with the meter's value shown on the secondary display (e.g. 4).
- Wait for approximately 30 seconds (until the reading of the calibrator is stable).
- Press CFM to enter. The meter will switch to the second calibration point. Repeat the above procedure.

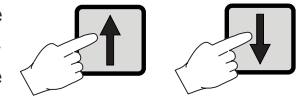

- After the desired readings are obtained, press CFM and the meter will skip back to normal operating mode.



Note When adjusting values using the \uparrow or \downarrow it is important to allow for sufficient response time (up to 30 seconds)

The table below lists the values of output codes along with the calibration point values (which are the analog output minimum and the analog output maximum) as indicated on the display.

The secondary display indicates the current calibration point value, while primary display indicates the current calibration type.

OUTPUT TYPE	CALIBRATION CODE	CALIBRATION POINT 1	CALIBRATION POINT 2
0-1 mA	0	0 mA	1 mA
0-20 mA	1	0 mA	20 mA
4-20 mA	2	4 mA	20 mA
0-5 Vdc	3	0 Vdc	5 Vdc
1-5 Vdc	4	1 Vdc	5 Vdc
0-10 Vdc	5	0 Vdc	10 Vdc

LAST CALIBRATION DATA

The meter stores the following information about last calibration in the EEPROM:

- Date
- Time
- Offset in mV (for pH 500 only)
- Up to two slopes (for pH 500 only)
- Up to three buffers

While displaying this data, the pH controller remains in control mode.

The procedure below indicates the flow for a three-point calibration. The sequence will vary if fewer calibration points are used (e.g. for a one-point calibration the following data will be displayed: date, time, offset, first slope, buffer 1 value). For the mV 600, last calibration data includes date and time of calibration and the values of the 2 calibration points. Displaying of these items follows the above sequence.

- To begin the cycle press CAL DATA. The last calibration date will appear on the main LCD display as DD.MM format, while the secondary display will show the year.

If the meter has never calibrated or an EEPROM reset has



occurred, no calibration data is shown when CAL DATA is pressed. The "no CAL" message will blink for a few seconds, then the meter skips back to normal mode.



- Pressing  will cycle through the following steps in reverse order, i.e. last buffer.



Note In any moment, by pressing LCD or CAL DATA the meter will return to the regular operating display.



- Press or to view the time of last calibration. The secondary display will show "HOU" to indicate hours.

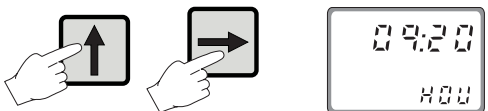

- Press or again to view the offset in mV at the time of last calibration. The secondary display will show "OFF" to indicate offset.

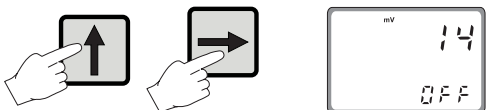

- Press or again to view the first slope in mV at the time of last calibration. The secondary display will show "SL1" to indicate first slope.



- Press or again to view the second slope in mV at the time of last calibration. The secondary display will show "SL2" to indicate second slope.



- Press or again to view the first memorized buffer at the time of last calibration. The secondary display will show "BUF1" to indicate first buffer.



- Press or again to view the second memorized buffer at the time of last calibration. The secondary display will show "BUF2" to indicate second buffer.



- Press or again to view the third memorized buffer at the time of last calibration. The secondary display will show "BUF3" to indicate third buffer.



- Press or again to return to the first CAL DATA display (date) at the time of last calibration.



STARTUP

At startup the firmware release code scrolls through the LCD; it is possible to escape from code scrolling pressing any key.

During the automatic startup the Real Time Clock (RTC) is checked to see if a reset occurred since last software initialization. In this case, the RTC is initialized with the default date and time 01/01/1997 - 00:00. An EEPROM reset does not affect the RTC settings.

The EEPROM is also checked to see if it is new. If this is the case, the default values are copied from ROM and then the device enters normal mode. Otherwise an EEPROM checksum test is performed (the same is performed during EEPROM selftest procedure).

If checksum is correct, normal mode is entered, otherwise user is asked whether the EEPROM should be reset.

If EEPROM reset is requested, default values from ROM are stored into EEPROM as would happen with a new EEPROM.

Note that EEPROM data is composed of setup data and calibration data. As for the setup data, the calibration data is assigned default values when an EEPROM reset occurs. An un-calibrated meter can perform measurement, though user is informed that pH calibration (pH models) or mV calibration (mV models) is needed by means a blinking "CAL" icon.

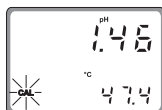

When the last calibration data is required, the "no CAL" message is displayed if no calibration procedure was performed.

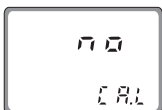

Unlike pH and mV calibration, user has no information on calibration need for other magnitudes, other than the awareness that EEPROM was reset.

After an EEPROM reset, all calibrations (input and output) have to be performed in order to obtain correct measurements.

FAULT CONDITIONS AND SELFTEST PROCEDURES

The fault conditions below may be detected by the software:

- EEPROM data error;
- I2C internal bus failure;
- code dead loop.

EEPROM data error can be detected through EEPROM test procedure at startup or when explicitly requested using setup menu.

When an EEPROM error is detected, user is given the option to perform a reset of EEPROM. Thus the reset can be performed whenever needed. It may be useful to provide a means to reset EEPROM directly (without a previous EEPROM error detection). This is done by pressing CFM first and then SETUP, \rightarrow and CAL DATA simultaneously.

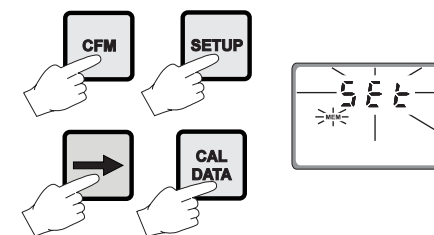

Note When an EEPROM reset has been performed calibration data are reset to default. An intermittent CAL will blink on the display to advise the user of this status.



A I2C failure is detected when the I2C transmission is not acknowledged or a bus fault occurs for more than a certain number of attempts (this can be due, for example, to damage sustained by one of the ICs connected to I2C bus).

If so, the controller stops any tasks and displays a perpetual sliding message "Serial bus error" (i.e. this is a fatal error).



The error detection for dead loops is performed by watchdog (see below).

You can use special setup codes, perform selftest procedures for LCD, keyboard, EEPROM, relays and LEDs, watchdog. The operation of these functions is outlined in the setup section. The selftest procedures are described in detail in the following subsections.

DISPLAY SELFTEST

The display selftest procedure consists of lighting up all of the display segments together. The Display test is announced by a scrolling "Display test" message.



The segments are lit for a few seconds and then switched off before exiting the selftest procedure.



KEYBOARD SELFTEST

The keyboard selftest procedure begins with the message "Button test, press LCD, CAL and SETUP together to escape". The LCD will then show only a colon.



As soon as one or more keys are pressed, the appropriate segments out of **88:88** corresponding to the pressed keys, will light up on the screen.

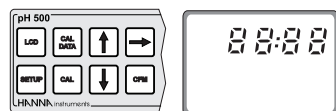

For example, if SETUP and CAL are pressed together the LCD will look like this:

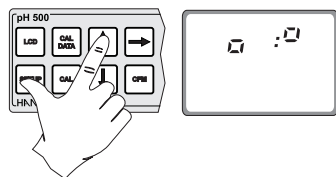

The colon is a useful indicator for the correct position of squares.

Note A maximum of two keys may be pressed simultaneously to be properly recognized.

To exit the keyboard test procedure press LCD, CAL and SETUP simultaneously.



EEPROM SELFTEST

The EEPROM selftest procedure involves verifying the stored EEPROM checksum. If the checksum is correct the "Stored data good" message will be shown for a few seconds before exiting selftest procedure.



If not, the message "Stored data error - Press [] to reset stored data or [] to ignore".



If [] is pressed the EEPROM selftest procedure terminates with no other action. Otherwise, EEPROM is reset with default values from ROM as when a device with a virgin EEPROM is switched on.

During EEPROM reset a blinking message "Set MEM" is shown on the LCD.

At the end of this operation all the parameters are reset to their default values. Calibration data is also reset. For this reason the "CAL" flag blinks until the pH calibration is performed.

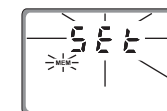

RELAYS AND LEDS

Relays and LEDs selftests are executed as follows:

First all of the relays and LEDs are switched off, then they are switched on one at a time for a few seconds and cyclically. User can interrupt the otherwise endless cycle, as indicated by the scrolling message, by pressing a key.



Note Relays and LEDs test has to be carried out with the relay contacts disconnected from external plant devices.

WATCHDOG

When a dead loop condition is detected a reset is automatically invoked.

The effectiveness of watchdog capability can be tested through one of the special setup items. This test consists of executing a dummy dead loop that causes watchdog reset signal to be generated.

pH VALUES AT VARIOUS TEMPERATURES

Temperature has a significant effect on pH. The calibration buffer solutions are effected by temperature changes to a lesser degree than normal solutions.

For manual temperature calibration please refer to the following chart:

TEMP		pH VALUES		
°C	°F	4.01	7.01	10.01
0	32	4.01	7.13	10.32
5	41	4.00	7.10	10.24
10	50	4.00	7.07	10.18
15	59	4.00	7.04	10.12
20	68	4.00	7.03	10.06
25	77	4.01	7.01	10.01
30	86	4.02	7.00	9.96
35	95	4.03	6.99	9.92
40	104	4.04	6.98	9.88
45	113	4.05	6.98	9.85
50	122	4.06	6.98	9.82
55	131	4.07	6.98	9.79
60	140	4.09	6.98	9.77
65	149	4.11	6.99	9.76
70	158	4.12	6.99	9.75

For instance, if the buffer temperature is 25°C, the display should show pH 4.01, 7.01 or 10.01 at pH 4, 7 or 10 buffers, respectively.

At 20°C, the display should show pH 4.00, 7.03 or 10.06. The meter reading at 50°C will then be 4.06, 6.98 or 9.82.

ELECTRODE CONDITIONING AND MAINTENANCE

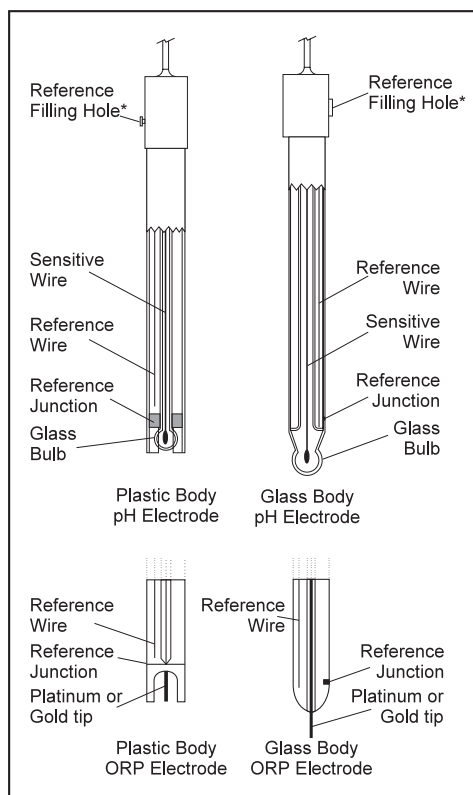

* Only available with refillable electrodes. For industrial applications, gel-filled electrodes are preferable due to lesser maintenance requirements.

PREPARATION

Remove the protective cap.

DO NOT BE ALARMED IF ANY SALT DEPOSITS ARE PRESENT.

This is normal with electrodes and they will disappear when rinsed with water.

During transport tiny bubbles of air may have formed inside the glass bulb. The electrode cannot function properly under these conditions. These bubbles can be removed by "shaking down" the electrode as you would do with a glass thermometer.

If the bulb and/or junction are dry, soak the electrode in **HI70300 storage solution** for at least one hour.

For refillable electrodes**:

If the refill solution (electrolyte) is more than 2½ cm (1") below the fill hole, add **HI 7082 3.5M KCl** electrolyte solution for double junction or **HI 7071 3.5M KCl+AgCl** electrolyte solution for single junction electrodes.

For AmpHel® electrodes:

If the electrode does not respond to pH changes, the battery is run down and the electrode should be replaced.

TEST MEASUREMENT

Rinse the electrode tip with distilled water.

Immerse the tip (bottom 4 cm / 1½") in the sample and stir gently for approximately 30 seconds.

For a faster response and to avoid cross contamination of the samples, rinse the electrode tip with the solution to be tested, before taking your measurements.

STORAGE

To minimize clogging and assure a quick response time, the glass bulb and the junction should be kept moist and not allowed to dry out. This can be achieved by installing the electrode in such a way that it is constantly in a well filled with the sample (stream or tank).

When not in use, replace the solution in the protective cap with a few drops of **HI 70300** storage solution or, in its absence, **HI 7007** pH 7.01 buffer solution.

Follow the Preparation Procedure above before taking measurements.

Note NEVER STORE THE ELECTRODE IN DISTILLED OR DEIONIZED WATER.

PERIODIC MAINTENANCE

Inspect the electrode and the cable. The cable used for the connection to the controller must be intact and there must be no points of broken insulation on the cable or cracks on the electrode stem or bulb.

Connectors must be perfectly clean and dry. If any scratches or cracks are present, replace the electrode. Rinse off any salt deposits with water.

For refillable electrodes**: Refill the electrode with fresh electrolyte (**HI 7071** for single junction or **HI 7082** for double junction electrodes). Allow the electrode to stand upright for 1 hour. Follow the Storage Procedure above.

CLEANING PROCEDURE

General Soak in Hanna **HI 7061** general cleaning solution for approximately 30 minutes.

Removal of films, dirt or deposits on the membrane/junction:

Protein Soak in Hanna **HI 7073** protein cleaning solution for 15 minutes.

Inorganic Soak in Hanna **HI 7074** inorganic cleaning solution for 15 minutes.

Oil/grease Rinse with Hanna **HI 7077** Oil & Fat cleaning solution.

IMPORTANT

After performing any of the cleaning procedures rinse the electrode thoroughly with distilled water, drain and refill the reference chamber with fresh electrolyte, (not necessary for gel-filled electrodes) and soak the electrode in **HI70300** storage solution for at least one hour before reinstalling it.

TROUBLESHOOTING

Evaluate your electrode performance based on the following.

- Noise (Readings fluctuate up and down) could be due to:
 - Clogged/Dirty Junction: refer to the Cleaning Procedure above.
 - Loss of shielding due to low electrolyte level (in refillable electrodes only): refill with **HI 7071** for single junction or **HI 7082** for double junction electrodes.
- Dry Membrane/Junction: soak in **HI 70300** storage solution for at least 1 hour. Check to make sure the installation is such as to create a well for the electrode bulb to constantly remain moist.
- Drifting: soak the electrode tip in warm Hanna **HI 7082** solution for one hour and rinse tip with distilled water (refill with fresh **HI7071** for single junction electrodes and **HI7082** for double junction electrodes if necessary).
- Low Slope: refer to the cleaning procedure above.

- No Slope:
 - Check the electrode for cracks in glass stem or bulb (replace the electrode if cracks are found).
 - Make sure cable and connections are not damaged nor lying in a pool of water or solution.
- Slow Response/Excessive Drift: soak the tip in the **HI 7061** solution for 30 minutes, rinse thoroughly in distilled water and then follow the Cleaning Procedure above.
- For ORP Electrodes: polish the metal tip with a lightly abrasive paper (paying attention not to scratch the surface) and wash thoroughly with water.

Note

With industrial applications, it is always recommended to keep at least one spare electrode handy. When anomalies are not resolved with a simple maintenance, change the electrode (and recalibrate the controller) to see if the problem is alleviated.

TAKING REDOX MEASUREMENTS

Redox measurements allow the quantification of the oxidizing or reducing power of a solution, and are commonly expressed in mV.

Oxidation may be defined as the process during which a molecule (or an ion) loses electrons and reduction as the process by which electrons are gained.

Oxidation is always coupled together with reduction so that as one element gets oxidized, the other is automatically reduced, therefore the term oxidation-reduction is frequently used.

Redox potentials are measured by an electrode capable of absorbing or releasing electrons without causing a chemical reaction with the elements with which it comes into contact. The electrodes most usually available for this purpose have gold or platinum surfaces; gold possesses a higher resistance than platinum in conditions of strong oxidation such as cyanide, while platinum is preferred for the measurements of oxidizing solutions containing halides and for general use.

When a platinum electrode is immersed in an oxidizing solution a monomolecular layer of oxygen is developed on its surface. This layer does not prevent the electrode from functioning, but it increases the response time. The opposite effect is obtained when the platinum surface absorbs hydrogen in the presence of reducing mediums. This phenomenon is rough on the electrode.

To make correct redox measurements the following conditions must prevail:

- The surface of the electrode must be cleaned and smooth.
- The surface of the electrode must undergo a pretreatment in order to respond quickly.

Because the Pt/PtO system depends on the pH, the pretreatment of the electrode may be determined by the pH and the redox potential values of the solution to be measured.

As a general rule, if the ORP mV reading corresponding to the pH value of the solution is higher than the values in the table below, an oxidizing pretreatment is necessary; otherwise a reducing pretreatment is necessary:

pH	mV	pH	mV	pH	mV	pH	mV	pH	mV
0	990	1	920	2	860	3	800	4	740
5	680	6	640	7	580	8	520	9	460
10	400	11	340	12	280	13	220	14	160

Reducing pretreatment: immerse the electrode for a few minutes in **HI 7091**.

Oxidizing pretreatment: immerse the electrode for a few minutes in **HI 7092**.

If the pretreatment is not performed, the electrode will take significantly longer to respond.

As with pH electrodes, gel-filled redox electrodes are more suitable for industrial applications due to lesser maintenance requirements. However, if working with refillable electrodes, the electrolyte level should not fall more than 2½ cm (1") below the fill hole and topped up if necessary. Use **HI 7071** Refill Solution for single junction and **HI 7082** for double junction electrodes.

In the event that measurements are performed with solutions containing sulfides or proteins, the cleaning of the diaphragm of the reference electrode must be performed more often to maintain the proper functioning of the ORP electrode. Therefore, immerse it into **HI 7020** and measure the response; the obtained value should be within 200 and 275 mV.

After this functional test, it is suggested to wash the electrode thoroughly with water and proceed to the oxidizing or reducing pretreatment before taking measurements.

When not in use, the electrode tip should be kept moist and far from any type of mechanical stress which might cause damage. This can be achieved by installing the electrode in such a way that it is constantly in a well filled with the sample (stream or tank). The protective cap can also be filled with **HI 70300** Storage Solution if the electrode is not being used at all.

Note With industrial applications, it is always recommended to keep at least one spare electrode handy. When anomalies are not resolved with a simple maintenance, change the electrode to see if the problem is alleviated.

ACCESSORIES

pH CALIBRATION SOLUTIONS

HI 7004M	pH 4.01 buffer solution, 230 mL bottle
HI 7004L	pH 4.01 buffer solution, 500 mL bottle
HI 7004/L	pH 4.01 buffer solution, 1 L bottle
HI 7007M	pH 7.01 buffer solution, 230 mL bottle
HI 7007L	pH 7.01 buffer solution, 500 mL bottle
HI 7007/L	pH 7.01 buffer solution, 1 L bottle
HI 7010M	pH 10.01 buffer solution, 230 mL bottle
HI 7010L	pH 10.01 buffer solution, 500 mL bottle
HI 7010/L	pH 10.01 buffer solution, 1 L bottle

ORP SOLUTIONS

HI 7020M	ORP test solution at 200-275 mV, 230 mL bottle
HI 7020L	ORP test solution at 200-275 mV, 500 mL bottle
HI 7091M	Reducing pretreatment solution, 230 mL bottle
HI 7091L	Reducing pretreatment solution, 500 mL bottle
HI 7092M	Oxidizing pretreatment solution, 230 mL bottle
HI 7092L	Oxidizing pretreatment solution, 500 mL bottle

ELECTRODE MAINTENANCE SOLUTIONS

HI 70300M	Storage solution, 230 mL bottle
HI 70300L	Storage solution, 500 mL bottle
HI 7061M	General cleaning solution, 230 mL bottle
HI 7061L	General cleaning solution, 500 mL bottle
HI 7073M	Protein cleaning solution, 230 mL bottle
HI 7073L	Protein cleaning solution, 500 mL bottle
HI 7074M	Inorganic cleaning solution, 230 mL bottle
HI 7074L	Inorganic cleaning solution, 500 mL bottle
HI 7077M	Oil & Fat cleaning solution, 230 mL bottle
HI 7077L	Oil & Fat cleaning solution, 500 mL bottle
HI 7071	3.5M KCl+AgCl electrolyte solution, 4x50 mL bottle, for single junction electrodes
HI 7072	1M KNO ₃ electrolyte solution, 4x50 mL bottle
HI 7082	3.5M KCl electrolyte solution, 4x50 mL bottle, for double junction electrodes

RECOMMENDED pH ELECTRODES (all electrodes are gel-filled and with ceramic junction unless otherwise indicated).

HI 1090T Screw connector, external PG13.5 thread, double junction, glass body, polymer filled

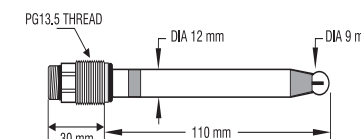

HI 1210T Screw connector, external PG13.5 thread, double junction, Plastic body; cloth junction (HI 1210T); PVDF junction, polymer-filled (HI 1211T)

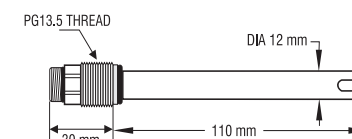

HI 2910B/5 BNC connector, 5 m (16.5') cable, double junction, plastic body with built-in amplifier and external thread; cloth junction (HI 2910B/5); PVDF junction, polymer-filled (HI 2911B/5)

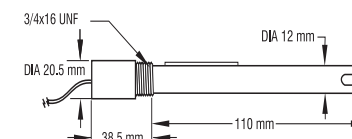

HI 1090B/5 BNC connector, 5 m (16.5') cable, double junction, glass body, polymer-filled

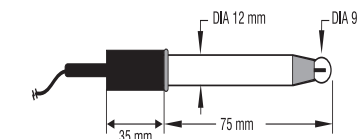

HI 1210B/5 BNC connector, 5 m (16.5') cable, double junction, plastic body, PVDF junction, polymer-filled

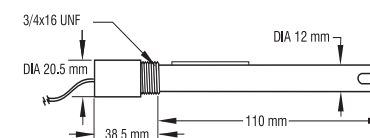

PLATINUM ORP ELECTRODES

HI 3090T Screw connector, external PG13.5 thread, double junction, Pt, glass body, polymer filled

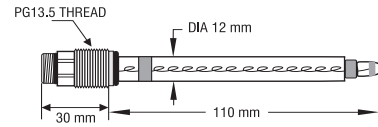

HI 3210T Screw connector, external PG13.5 thread, double junction, Pt, plastic body, cloth junction

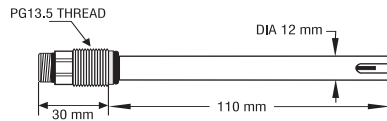

HI 3211T Screw connector, external PG13.5 thread, double junction, Pt, plastic body, PVDF junction, polymer-filled

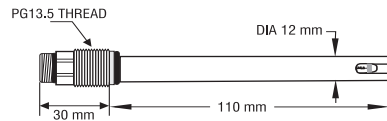

HI 2930B/5 BNC connector, 5 m (16.5') cable, double junction, Pt, plastic body with built-in amplifier and external thread, cloth junction

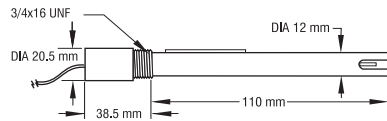

HI 2931B/5 BNC connector, 5 m (16.5') cable, double junction, Pt, plastic body with built-in amplifier and external thread, PVDF junction, polymer-filled

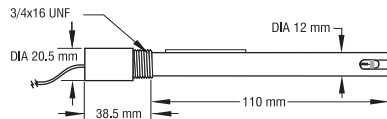

HI 3090B/5 BNC connector, 5 m (16.5') cable, double junction, Pt, glass body, polymer-filled

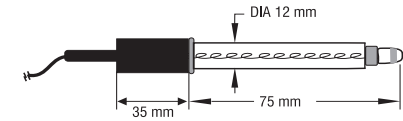

HI 3210B/5 BNC connector, 5 m (16.5') cable, double junction, Pt, plastic body, PVDF junction, polymer-filled

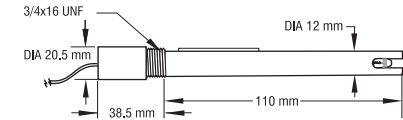

GOLD ORP ELECTRODES

HI 4932B/5 BNC connector, 5 m (16.5') cable, double junction, Au, plastic body with built-in amplifier and external thread

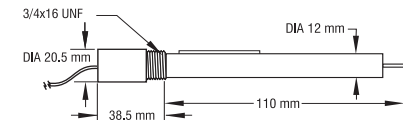

ELECTRODES FOR HIGH PRESSURE APPLICATIONS

pH ELECTRODES

1/2" thread, double PVDF junction, polymer filled, max operating pressure of 6 bar (87 psi)

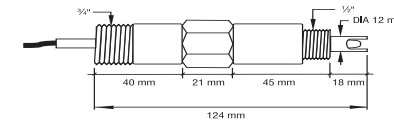

Part Code	Matching Pin	Amplifier	Connector	Cable
HI 1002/3	NO	NO	BNC	3 m (10')
HI 1002/5	NO	NO	BNC	5 m (16.5')
HI 1003/3	YES	NO	BNC*	3 m (10')
HI 1003/5	YES	NO	BNC*	5 m (16.5')
HI 1004/5	YES	YES	spade lugs*	5 m (16.5')

* In addition to the electrode connector, there is also a spade lug connection for the matching pin

ORP ELECTRODES

1/2" thread, double PVDF junction, polymer filled, max operating pressure of 6 bar (87 psi)

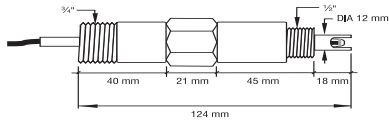

PLATINUM ELECTRODES

Part Code	Matching Pin	Amplifier	Connector	Cable
HI 2002/3	NO	NO	BNC	3 m (10')
HI 2002/5	NO	NO	BNC	5 m (16.5')
HI 2003/3	YES	NO	BNC*	3 m (10')
HI 2003/5	YES	NO	BNC*	5 m (16.5')
HI 2004/5	YES	YES	spade lugs*	5 m (16.5')

GOLD ELECTRODES

Part Code	Matching Pin	Amplifier	Connector	Cable
HI 2012/3	NO	NO	BNC	3 m (10')
HI 2012/5	NO	NO	BNC	5 m (16.5')
HI 2013/3	YES	NO	BNC*	3 m (10')
HI 2013/5	YES	NO	BNC*	5 m (16.5')
HI 2005/5	YES	YES	spade lugs*	5 m (16.5')

* In addition to the electrode connector, there is also a spade lug connection for the matching pin

OTHER ACCESSORIES

BL PUMPS	Dosing pumps with flow rate from 1.5 to 20 lph
HI 98501 <i>ChecktempC</i>	Electronic thermometer (range -50.0 to 150.0°C)
HI 98502 <i>ChecktempF</i>	Electronic thermometer (range -58.0 to 302°F)
HI 6050 & HI 6051	Submersible electrode holders
HI 6054 & HI 6057	Electrode holders for in-line applications
HI 778P	Screened coaxial cable with screw connectors
HI 7871 & HI 7873	Level controllers
HI 8427	pH/ORP electrode simulator
HI 8614	pH transmitter
HI 8614L	pH transmitter with LCD
HI 8615	ORP transmitter
HI 8615L	ORP transmitter with LCD
HI 920010	RS232 connection cable
HI 92500	Windows® compatible software
HI 931001	pH/ORP electrode simulator with LCD
HI 931002	4-20 mA simulator

WARRANTY

All Hanna Instruments **meters are guaranteed for two years** against defects in workmanship and materials when used for their intended purpose and maintained according to instructions. **The electrodes and the probes are guaranteed for a period of six months.** This warranty is limited to repair or replacement free of charge.

Damage due to accident, misuse, tampering or lack of prescribed maintenance are not covered.

If service is required, contact the dealer from whom you purchased the instrument. If under warranty, report the model number, date of purchase, serial number and the nature of the failure. If the repair is not covered by the warranty, you will be notified of the charges incurred. If the instrument is to be returned to Hanna Instruments, first obtain a Returned Goods Authorization number from the Customer Service department and then send it with shipping costs prepaid. When shipping any instrument, make sure it is properly packaged for complete protection.

Hanna Instruments reserves the right to modify the design, construction and appearance of its products without advance notice.

OTHER PRODUCTS FROM HANNA

- CALIBRATION AND MAINTENANCE SOLUTIONS
- CHEMICAL TEST KITS
- CHLORINE METERS
- CONDUCTIVITY/TDS METERS
- DISSOLVED OXYGEN METERS
- HYGROMETERS
- ION SPECIFIC METERS
- MAGNETIC STIRRERS
- Na/NaCl METERS
- pH/ORP/Na ELECTRODES
- PROBES (DO, μ S/cm, RH, T, TDS)
- PUMPS
- REAGENTS
- SOFTWARE
- THERMOMETERS
- TITRATORS
- TRANSMITTERS
- TURBIDITY METERS
- Wide Range of Accessories



Most Hanna meters are available in the following formats:

- BENCH-TOP METERS
- POCKET-SIZED METERS
- PORTABLE METERS
- PRINTING/LOGGING METERS
- PROCESS METERS (Panel and Wall-mounted)
- METERS FOR FOOD INDUSTRY

For additional information, contact your dealer or the nearest Hanna Customer Service Center.

You can also e-mail us at tech@hannainst.com.

CE DECLARATION OF CONFORMITY

 CE DECLARATION OF CONFORMITY
We Hanna Instruments Italia Srl via E.Fermi, 10 35030 Sarneola di Rubano - PD ITALY
herewith certify that the microprocessor-based process controllers
pH 500111 pH 500112 pH 500121 pH 500122 pH 500211 pH 500212 pH 500221 pH 500222 mV 600111 mV 600112 mV 600121 mV 600122
have been tested and found to be in compliance with EMC Directive 89/336/EEC and Low Voltage Directive 73/23/EEC according to the following applicable normatives:
EN 50082-1: Electromagnetic Compatibility - Generic Immunity Standard IEC 801-2 Electrostatic Discharge IEC 801-3 RF Radiated IEC 801-4 Fast Transient
EN 50081-1: Electromagnetic Compatibility - Generic Emission Standard EN 55022 Radiated, Class B
EN61010-1: Safety requirements for electrical equipment for measurement, control and laboratory use
Date of Issue: <u>27-05-1998</u>
 P. Cesa - Technical Director On behalf of Hanna Instruments S.r.l.

Recommendations for Users

Before using these products, make sure that they are entirely suitable for the environment in which they are used.

Operation of these instruments in residential areas could cause unacceptable interferences to radio and TV equipment.

To maintain the EMC performance of equipment, the recommended cables noted in the user's manual must be used.

Any variation introduced by the user to the supplied equipment may degrade the instruments' EMC performance.

To avoid electrical shock, do not use these instruments when voltage at the measurement surface exceed 24 Vac or 60 Vdc.

To avoid damage or burns, do not perform any measurement in microwave ovens.

Unplug the instruments from power supply before the replacement of the fuse.

External cables to be connected to the rear panel should be terminated with cable lugs.

HANNA LITERATURE

Hanna publishes a wide range of catalogs and handbooks for an equally wide range of applications. The reference literature currently covers areas such as:

- Water Treatment
- Process
- Swimming Pools
- Agriculture
- Food
- Laboratory
- Thermometry

and many others. New reference material is constantly being added to the library.

For these and others catalogs, handbooks and leaflets, contact your dealer or the Hanna Customer Service Center nearest to you. To find the Hanna Office in your vicinity, check our home page at www.hannainst.com

TECHNICAL SERVICE CONTACTS

Australia: Tel. (03) 9769.0666 • Fax (03) 9769.0699

China: Tel. (10) 88570068 • Fax (10) 88570060

Egypt: Tel. & Fax (02) 2758.683

Germany: Tel. (07851) 9129-0 • Fax (07851) 9129-99

Greece: Tel. (210) 823.5192 • Fax (210) 884.0210

Indonesia: Tel. (21) 4584.2941 • Fax (21) 4584.2942

Japan: Tel. (03) 3258.9565 • Fax (03) 3258.9567

Korea: Tel. (02) 2278.5147 • Fax (02) 2264.1729

Malaysia: Tel. (603) 5638.9940 • Fax (603) 5638.9829

Singapore: Tel. 6296.7118 • Fax 6291.6906

South Africa: Tel. (011) 615.6076 • Fax (011) 615.8582

Taiwan: Tel. 886.2.2739.3014 • Fax 886.2.2739.2983

Thailand: Tel. 66.2619.0708 • Fax 66.2619.0061

United Kingdom: Tel. (01525) 850.855 • Fax (01525) 853.668

USA: Tel. (401) 765.7500 • Fax (401) 765.7575

*For additional Technical Support in your local language,
see **www.hannainst.com***